

Quick Reference Guide

Stichwortregister

Guide de référence rapide

Beknopte bedieningsgids

Guida di riferimento rapido

Guía de referencia rápida

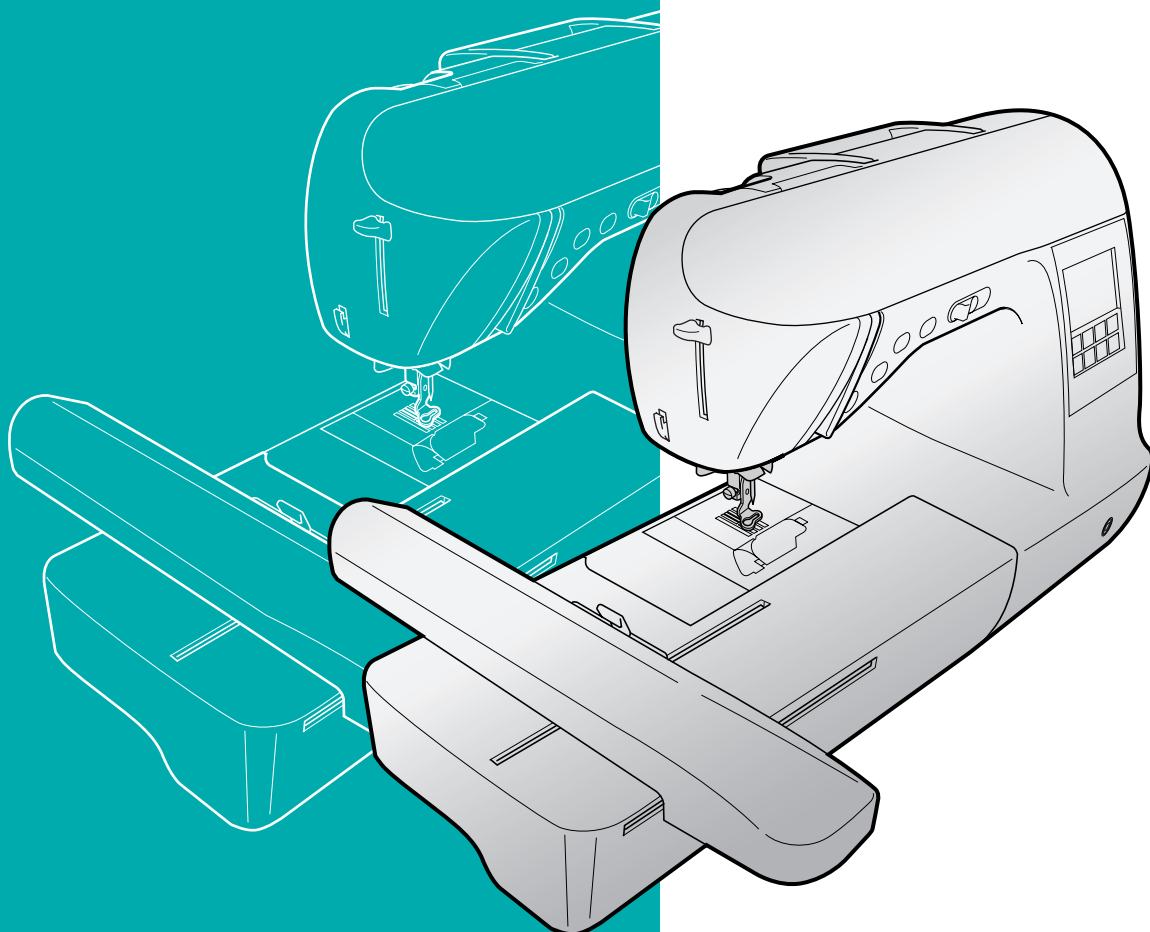

Refer to the operation manual for detailed instruction.

Also, there are differences in the keys and screens depending on the display language. In this guide, English screens are used for basic explanations.

Einzelheiten entnehmen Sie bitte der Bedienungsanleitung.

Je nachdem, welche Sprache für die Bildschirmanzeigen gewählt wurde, ergeben sich im Hinblick auf Tasten Schirmbilder eventuell Unterschiede.

Die grundlegende Bedienung der Maschine ist in dieser Anleitung am Beispiel von Schirmbildern mit englischem Text erklärt.

Pour les instructions détaillées, voir le mode d'emploi.

Par ailleurs, il y a des différences dans les touches et les écrans en fonction de la langue d'affichage. Dans ce guide, les explications de base utilisent les écrans anglais.

Zie de gebruiksaanwijzing voor gedetailleerde instructies.

Er zijn verschillen in de toetsen en schermen afhankelijk van de ingestelde taal.

In de beschrijvingen in deze beknopte handleiding worden de Engelse schermen gebruikt.

Fare riferimento al manuale di impiego per istruzioni dettagliate.

Inoltre, ci sono differenze nei tasti e nelle schermate a seconda della lingua visualizzata.

In questa guida, le schermate in inglese sono usate per le spiegazioni basilari.

Consulte el manual de instrucciones para ver más detalles.

Además, dependiendo del idioma visualizado algunos botones y pantallas podrán ser diferentes.

En esta guía, para las explicaciones básicas se emplean pantallas en inglés.

Contents

Bobbin Winding and Setting	2
Upper Threading	4
Selecting Stitch Patterns	6
◆ Utility Stitches	6
◆ Other Stitches	6
Summary of Stitch Patterns	7
◆ Utility Stitches	7
◆ Other Stitches	7
◆ Character stitches	9
Preparing to Embroider	10
Selecting Embroidery Patterns	12
Character Patterns	13
Frame patterns	15
Embroidery Pattern Color Change Table	16
Color Thread Conversion Chart	25

Table des matières

Bobinage et réglage de la canette	2
Enfilage supérieur	4
Sélection des configurations de point	6
◆ Points utilitaires	6
◆ Autres points	6
Sommaires des motifs de point	7
◆ Points utilitaires	7
◆ Autres points	7
◆ Points caractère	9
Préparation de la broderie	10
Sélection des motifs de broderie	12
Motifs de caractères	13
Motifs cadres	15
Tableau de changement de couleur des motifs de broderie	16
Tableau de conversion des fils de couleur	25

Indice

Avvolgimento spolina e caricamento	2
Infilatura superiore	4
Selezione degli schemi punto	6
◆ Punti utili	6
◆ Altri punti	6
Sommario degli schemi punto	7
◆ Punti utili	7
◆ Altri punti	7
◆ Punto con caratteri	9
Preparativi per il ricamo	10
Selezione degli schemi di ricamo	12
Schemi con lettere	13
Motivi a cornicetta	15
Tabella di cambiamento colori degli schemi di ricamo	16
Tabella di conversione dei fili colorati	25

Inhalt

Aufspulen des Unterfadens und Einstellung	2
Einfädeln des Oberfadens	4
Wahl des Nähmusters	6
◆ Nutztiche	6
◆ Weitere Stiche	6
Nähmuster-Übersicht	7
◆ Nutztiche	7
◆ Weitere Stiche	7
◆ Buchstaben stiche	9
Vorbereitung zum Sticken	10
Wählen von Stickmustern	12
Zeichnmuster	13
Rahmenmuster	15
Stickmuster-Farbtabelle	16
Stickgarn-Farbtabelle	25

Inhoudsopgave

Opwinden en instellen van de spoel	2
Inrijgen van de bovendraad	4
Kiezen van de steekpatronen	6
◆ Naaisteken	6
◆ Andere steken	6
Overzicht van de steekpatronen	7
◆ Naaisteken	7
◆ Andere steken	7
◆ Lettersteken	9
Vorbereidingen voor borduren	10
Kiezen van borduurpatronen	12
Karakterpatronen	13
Kaderpatronen	15
Kleurwijzigingstabel voor de borduurpatronen ...	16
Omzettingstabel voor kleurgaren	25

Contenido

Bobinado y ajuste	2
Hilo superior	4
Selección de tipos de puntada	6
◆ Puntadas utiles	6
◆ Otras puntadas	6
Resumen de tipos de puntada	7
◆ Puntadas utiles	7
◆ Otras puntadas	7
◆ Costuras dos caracteres	9
Preparativos para bordar	10
Selección de diseños de bordados	12
Tipos de caracteres	13
Costuras de encuadre	15
Tabla de cambio de color para patrones de bordado	16
Tabla de conversión de hilos de color	25

Bobbin Winding and Setting

Aufspulen des Unterfadens und Einstellung

Bobinage et réglage de la canette

Opwinden en instellen van de spoel

Avvolgimento spolina e caricamento

Bobinado y ajuste

Follow the numbered steps below in order. Refer to the operation manual for detailed instruction.

Führen Sie die folgenden Schritte in der angegebenen Reihenfolge aus. Ausführliche Hinweise finden Sie in der Bedienungsanleitung.

Suivez les étapes numérotées ci-dessous dans l'ordre. Consultez le manuel d'instructions pour des procédures détaillées.

Voer de genummerde stappen uit in de juiste volgorde. Uitvoerige aanwijzingen vindt u in de bedieningshandleiding.

Seguire i passaggi numerati nell'ordine riportato di seguito. Fare riferimento al manuale d'istruzioni per le istruzioni dettagliate.

Realice los siguientes pasos numerados en el orden indicado. Para obtener instrucciones detalladas, consulte el manual de instrucciones.

Use only the enclosed bobbin or bobbins of the same type.

Verwenden Sie nur die im Lieferumfang enthaltene Spule oder Spulen vom selben Typ.

N'utilisez que la canette fournie ou des canettes du même type.

Gebruik alleen de bijgeleverde spoel of spoelen van hetzelfde type.

Utilizzare solo la spolina inclusa o spoline dello stesso tipo.

Utilice sólo la bobina incluida o bobinas del mismo tipo.

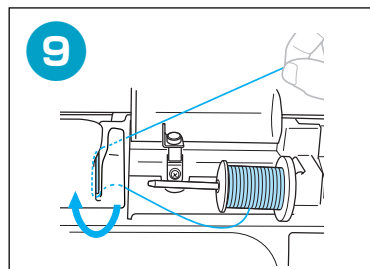
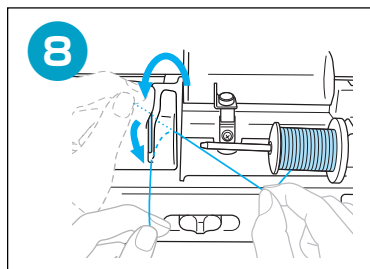
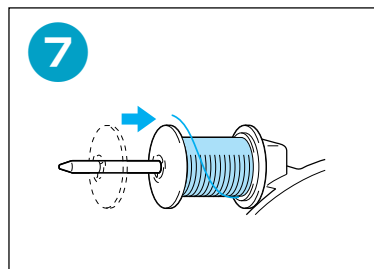
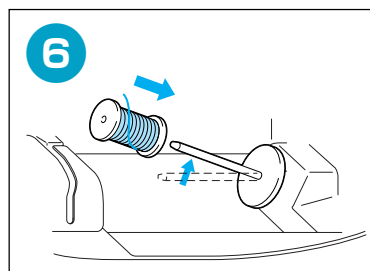
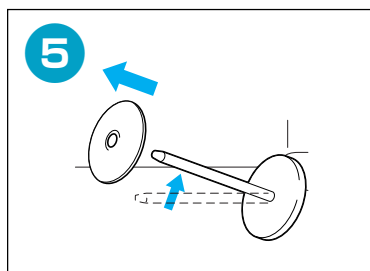
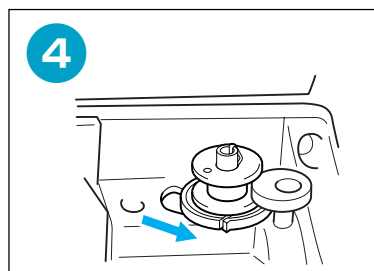
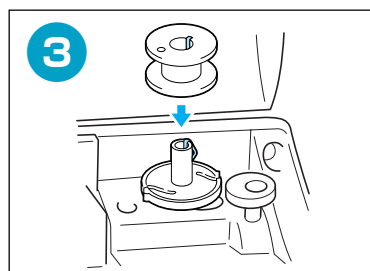
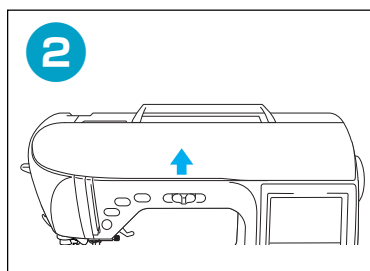
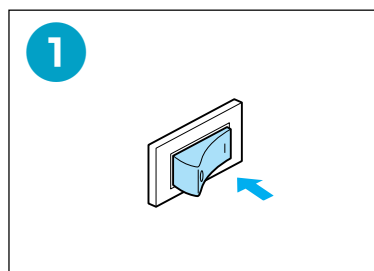
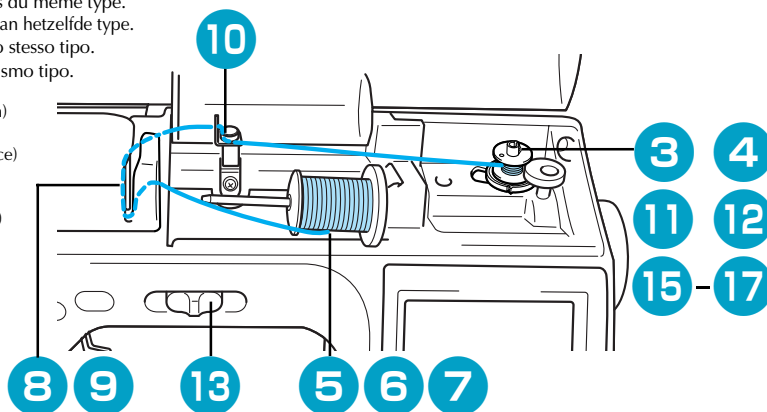
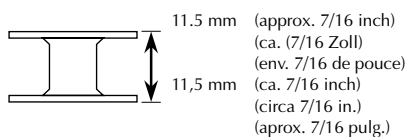

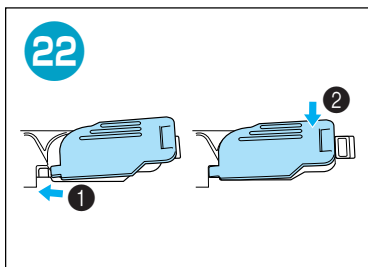
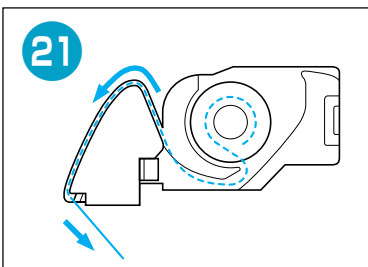
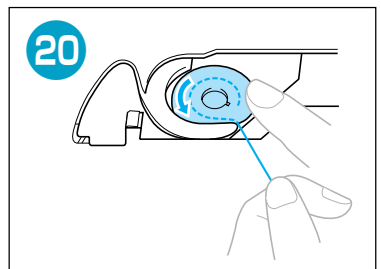
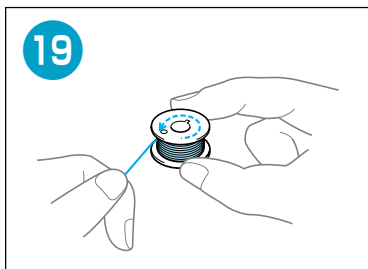
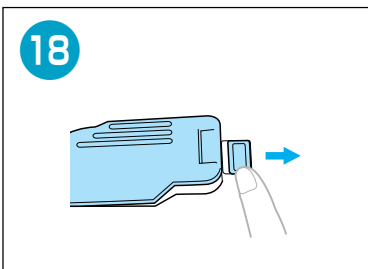
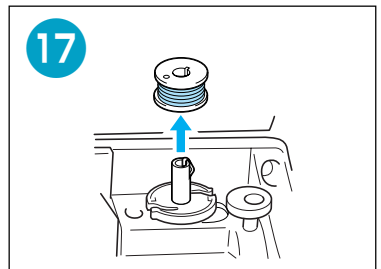
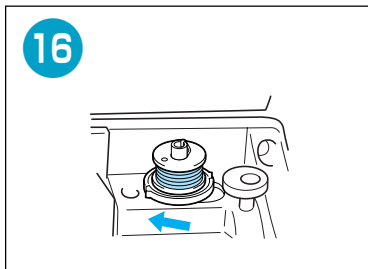
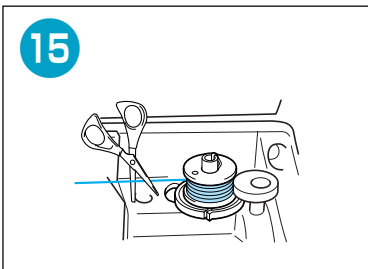
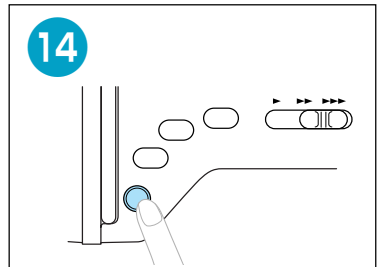
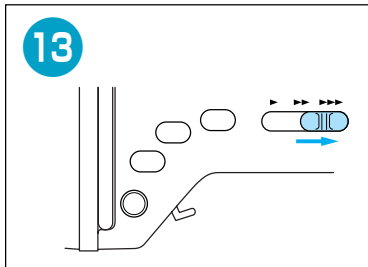
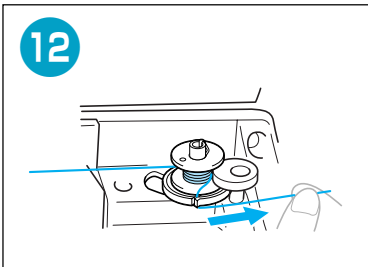
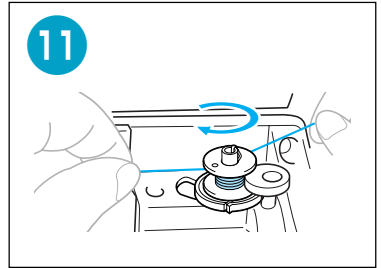
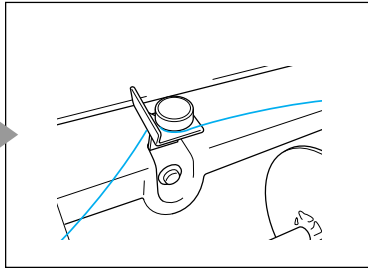
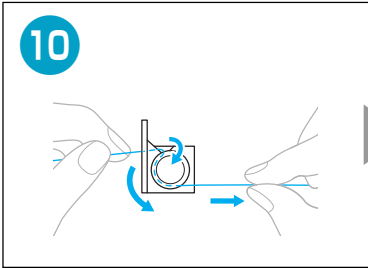

Upper Threading
 Einfädeln des Oberfadens
 Enfilage supérieur
 Inrijgen van de bovendraad
 Infilatura superiore
 Hilo superior

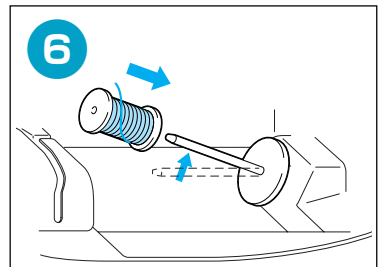
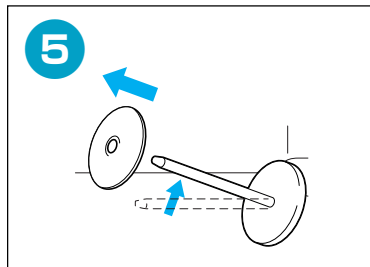
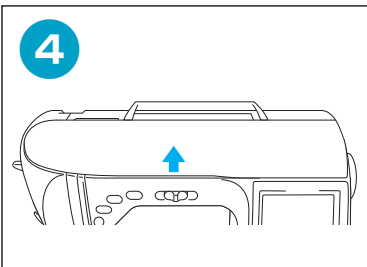
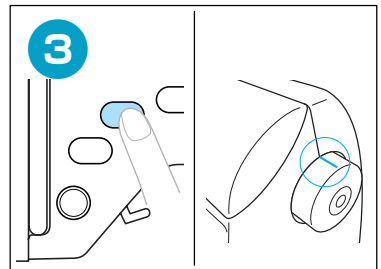
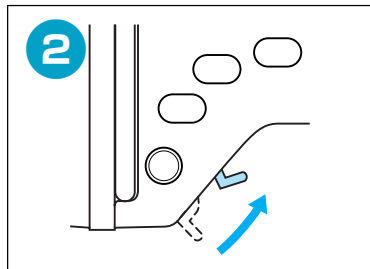
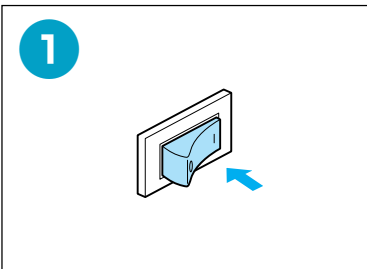
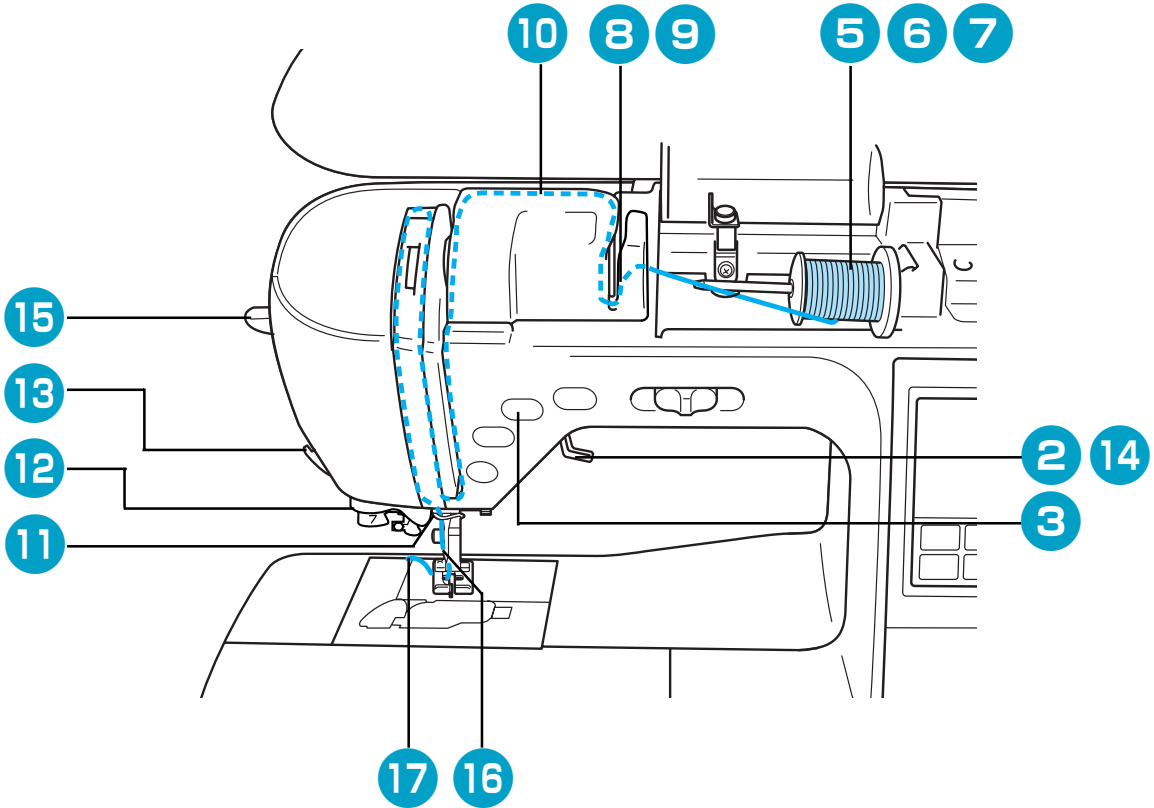

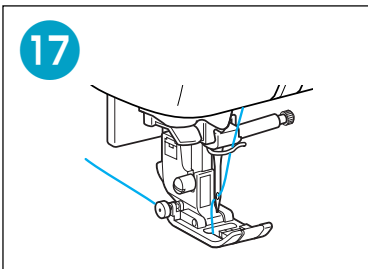
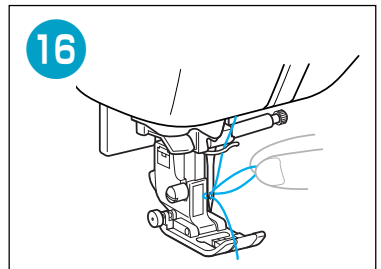
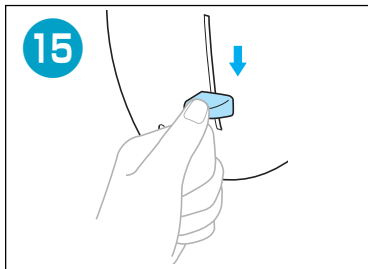
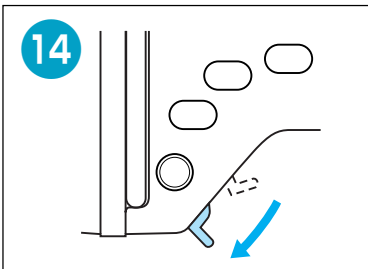
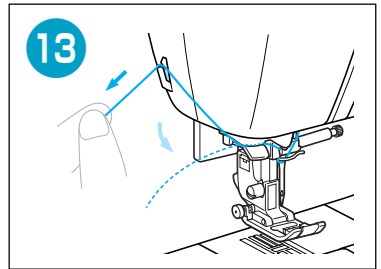
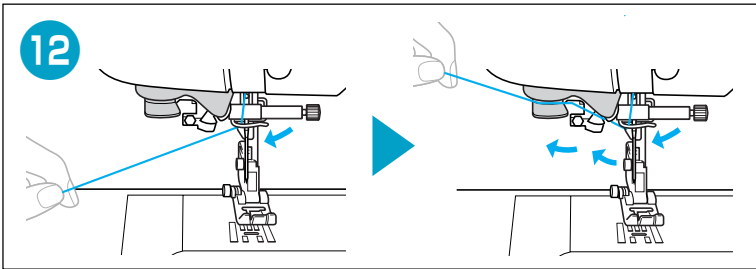
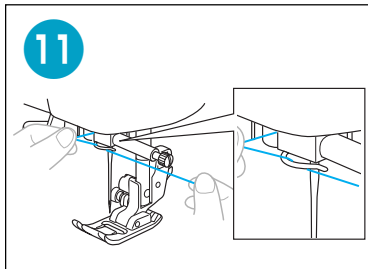
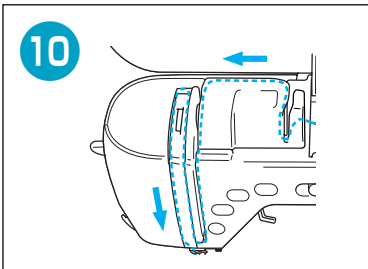
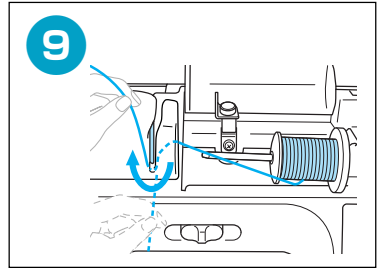
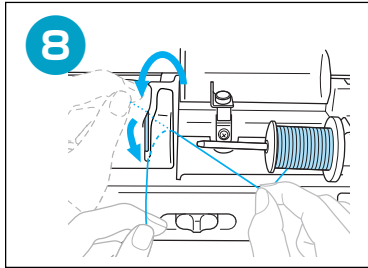
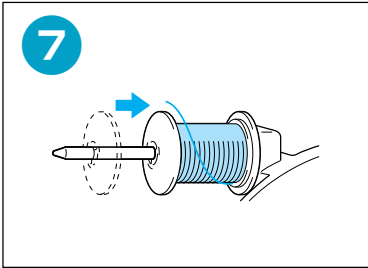

Selecting Stitch Patterns

Wahl des Nähmusters

Sélection des configurations de point

Kiezen van de steekpatronen

Selezione degli schemi punto

Selección de tipos de puntada

- ◆ Utility Stitches ◆ Nutzstiche ◆ Points utiles
- ◆ Naaisteken ◆ Punti utili ◆ Puntadas utiles

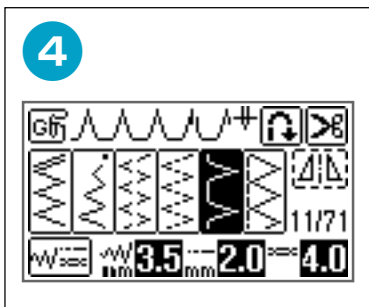
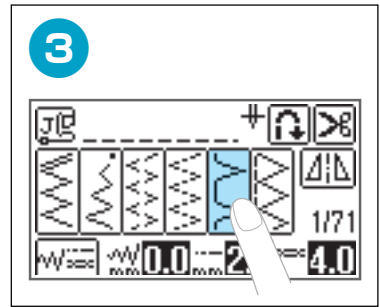
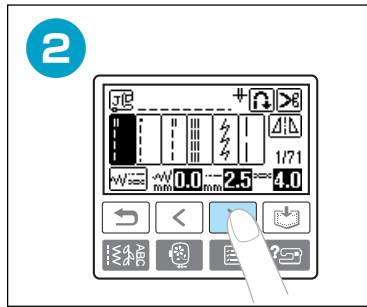
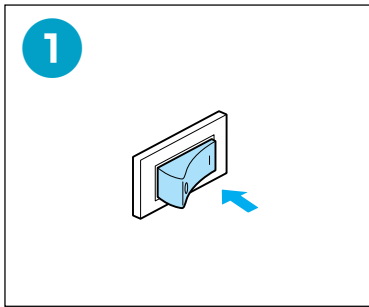

- ◆ Other Stitches ◆ Weitere Stiche ◆ Autres points
- ◆ Andere steken ◆ Altri punti ◆ Otras puntadas

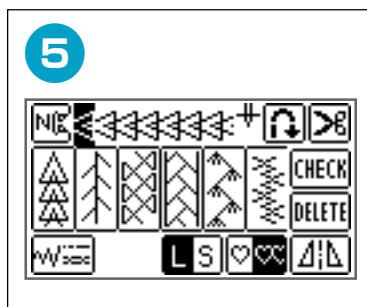
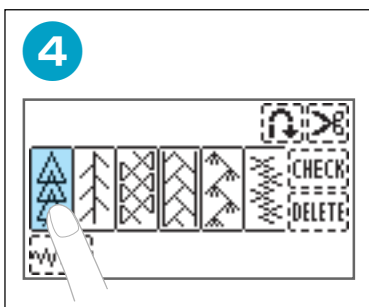
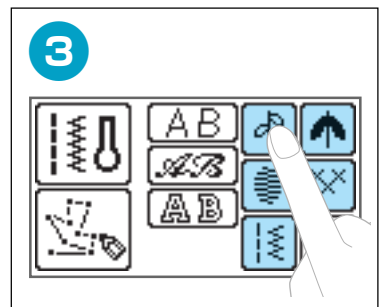
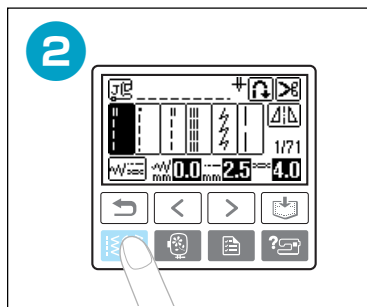
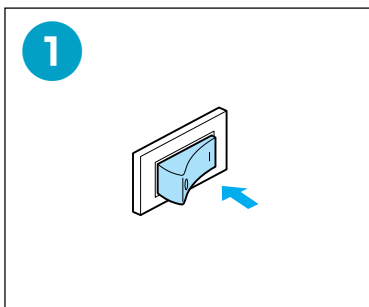

Summary of Stitch Patterns

Nähmuster-Übersicht

Sommaires des motifs de point

Overzicht van de steekpatronen

Sommario degli schemi punto

Resumen de tipos de puntada



- ◆ Utility Stitches
- ◆ Naaijsteken
- ◆ Nutzstiche
- ◆ Punti utili
- ◆ Points utilitaires
- ◆ Puntadas utiles

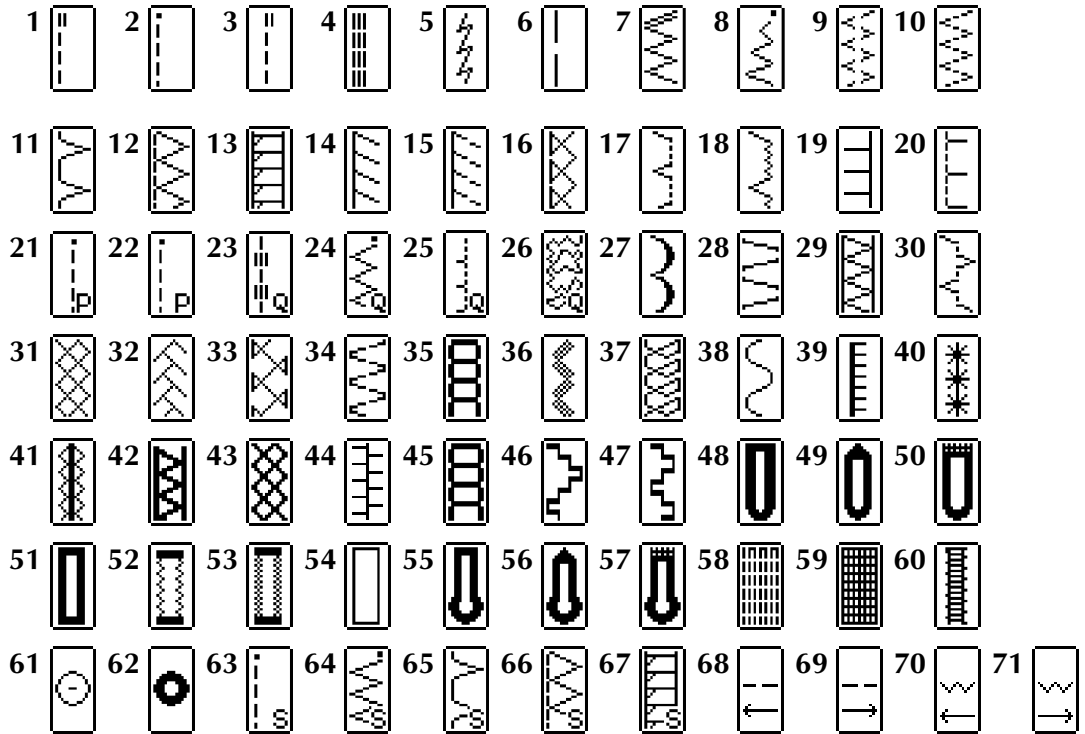

- ◆ Other Stitches
- ◆ Weitere Stiche
- ◆ Autres points
- ◆ Andere steken
- ◆ Altri punti
- ◆ Otras puntadas



- Decorative stitches
- Zierstiche
- Points décoratifs
- Decoratieve steken
- Punti decorativi
- Puntadas decorativas

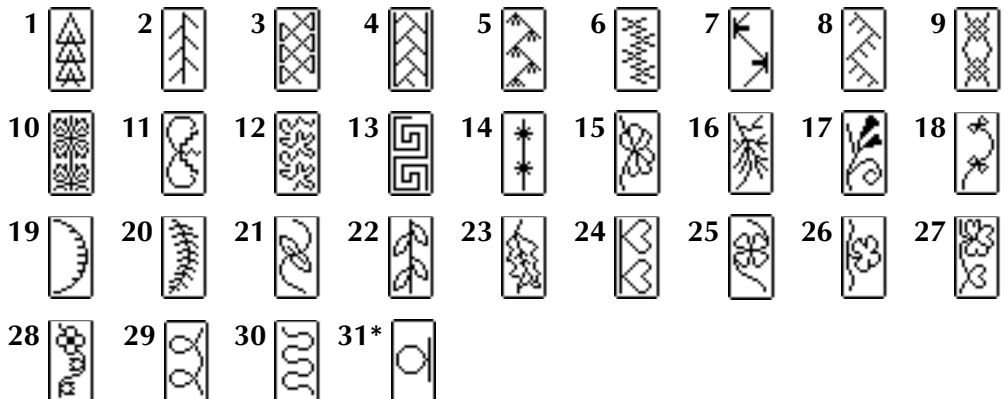

* Pattern for making adjustment
* Patroon voor het maken van afstellingen

* Muster für Einstellungen
* Schema per eseguire la regolazione

* Motif pour effectuer un réglage
* Dibujo para hacer ajustes

 ■ **Satin stitches** ■ **Satinstiche** ■ **Points plumetis**
 ■ **Satijnen steken** ■ **Punti a raso** ■ **Puntadas para satén**

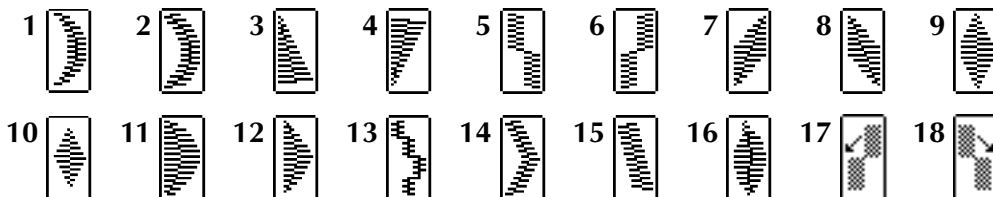

 ■ **Cross-stitches** ■ **Kreuzstiche** ■ **Points croisés**
 ■ **Kruissteken** ■ **Punti croce** ■ **Costura cruzada**

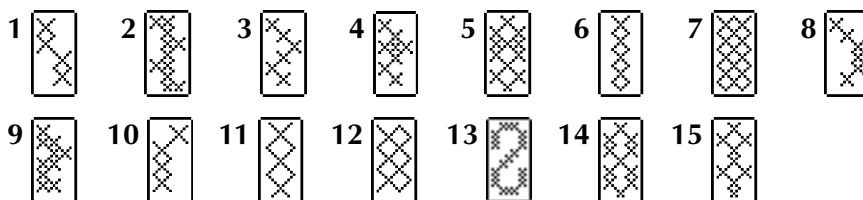

 ■ **Decorative Satin stitches** ■ **Satin Zierstiche** ■ **Points plumetis décoratifs**
 ■ **Decoratieve satijnen steken** ■ **Punt decorativi a raso** ■ **Puntadas decorativas para satén**



 ■ **Combined Utility Stitches** ■ **Kombinierte Gebrauchsstiche** ■ **Point utilitaires combinés**
 ■ **Gecombineerde naaisteken** ■ **Punti utili combinati** ■ **Puntadas de utilidad combinadas**

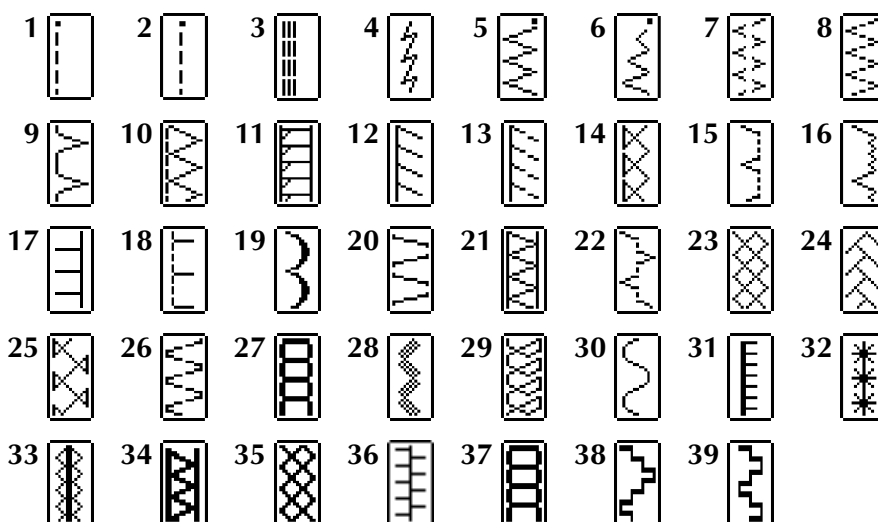

Summary of Stitch Patterns
 Nähmuster-Übersicht
 Sommaires des motifs de point
 Overzicht van de steekpatronen
 Sommario degli schemi punto
 Resumen de tipos de puntada

- ◆ Character Stitches
- ◆ Lettersteken

- ◆ Buchstaben stiche
- ◆ Punto con caratteri

- ◆ Points caractère
- ◆ Costuras de caracteres



- Gothic font
- type Gothic

- Schriftart Gotisch
- carattere gotico

- Police Gothique
- Letra gótica

ABCDEFGHIJKLMNOPQRS
 TUVWXYZ
 0123456789
 &?!-_() ' . ,
 Ä Å Æ Ñ Ö Ø Ç Ü ß
 a b c d e f g h i j k l m n o p q r s
 t u v w x y z
 ä å æ è é ê ë ñ ö ø ò ó î ç ü ù



- Script font
- type Script

- Schriftart Script
- carattere in corsivo

- Police Script
- Letra escritura

*ABCDEFGHIJKLMNOPQRS
 TUVWXYZ
 0123456789
 &?!-_() ' . ,
 Ä Å Æ Ñ Ö Ø Ç Ü ß
 a b c d e f g h i j k l m n o p q r s
 t u v w x y z
 ä å æ è é ê ë ñ ö ø ò ó î ç ü ù*



- Outline style
- opmaak Contour

- Schriftart Umriss
- stile contorno

- Style contours
- Estilo de contorno

ABCDEFGHIJKLMNOPQRS
 TUVWXYZ
 0123456789
 &?!-_() ' . ,
 Ä Å Æ Ñ Ö Ø Ç Ü ß
 a b c d e f g h i j k l m n o p q r s
 t u v w x y z
 ä å æ è é ê ë ñ ö ø ò ó î ç ü ù

Preparing to Embroider

Vorbereitung zum Sticken

Préparation de la broderie

Vorbereidingen voor borduren

Preparativi per il ricamo

Preparativos para bordar

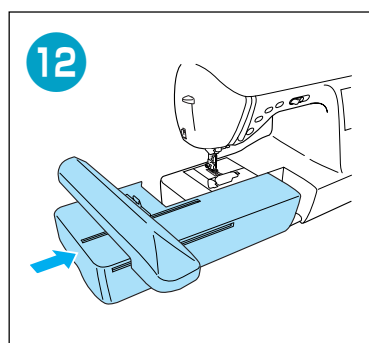
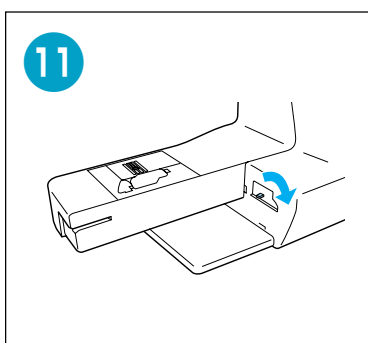
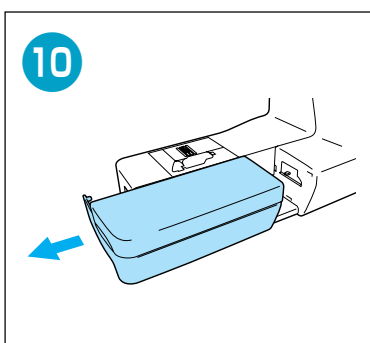
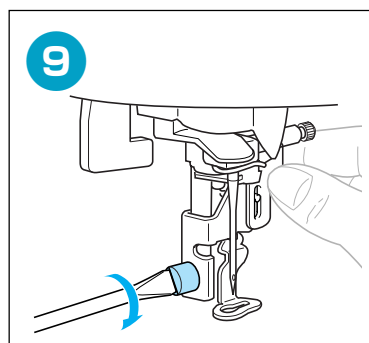
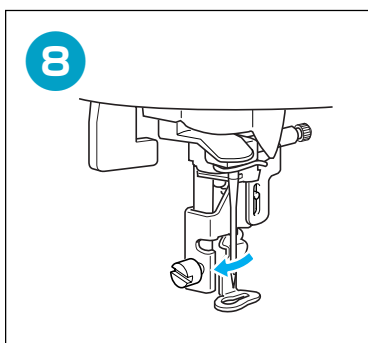
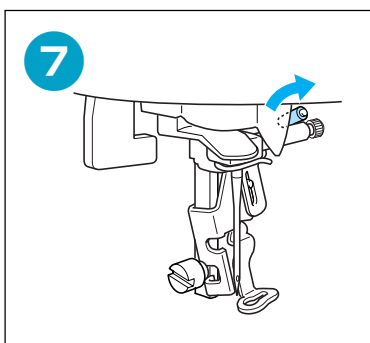
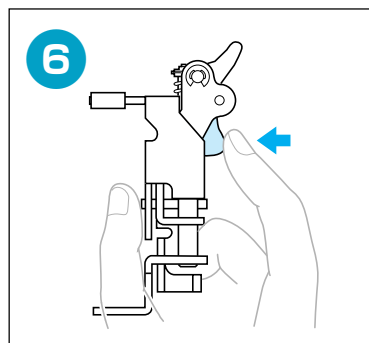
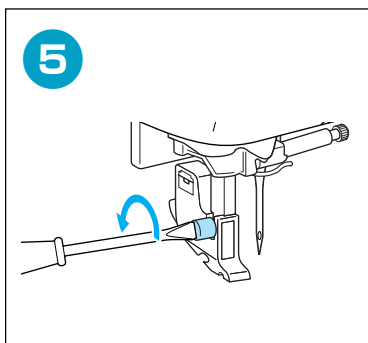
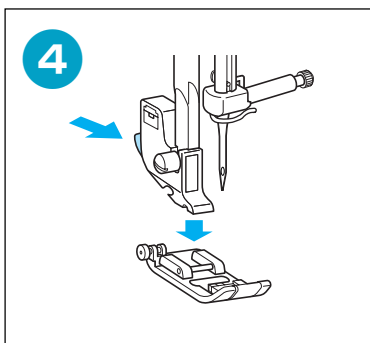
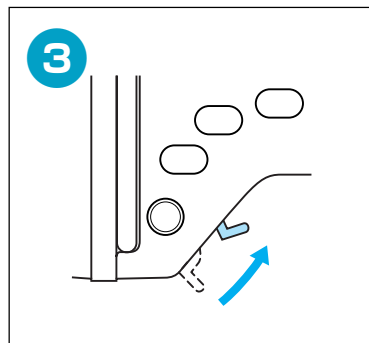
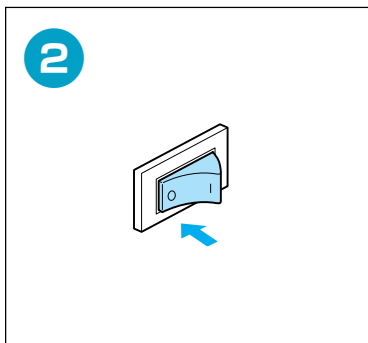
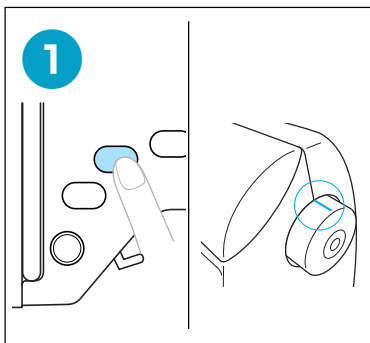

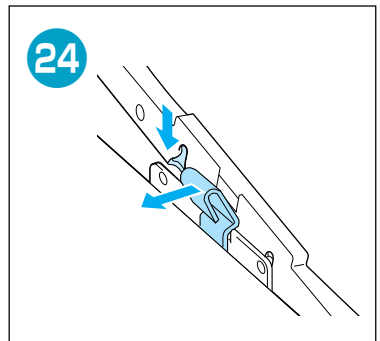
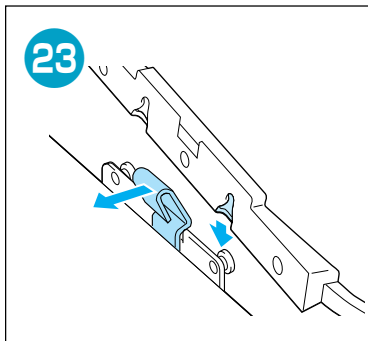
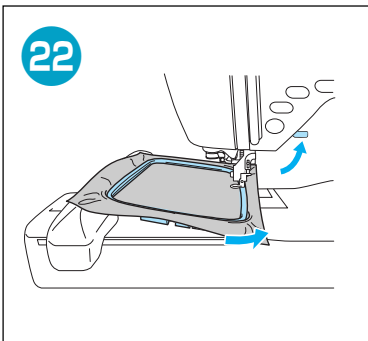
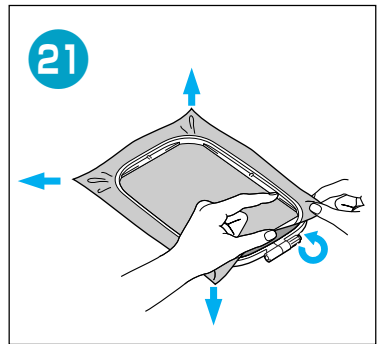
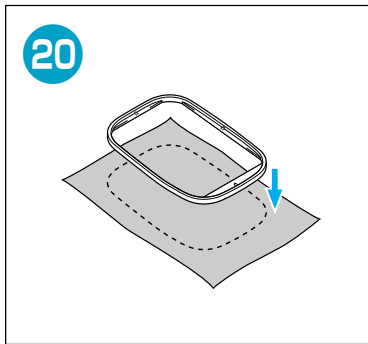
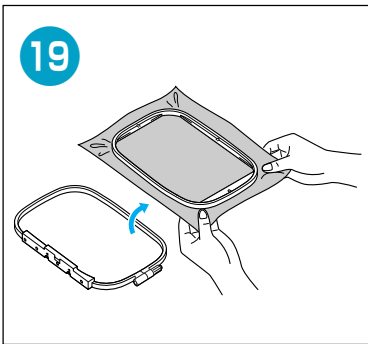
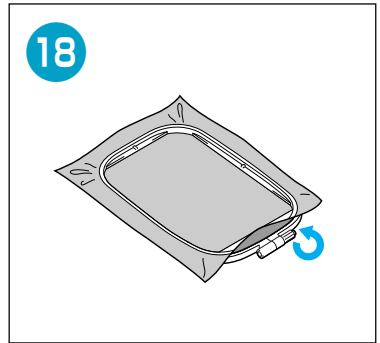
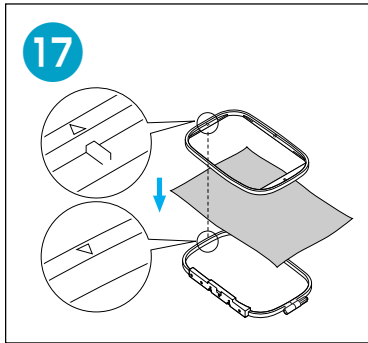
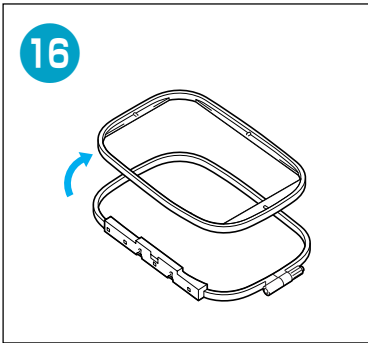
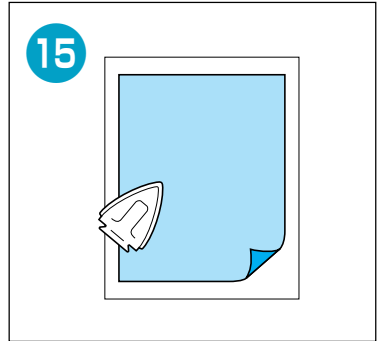
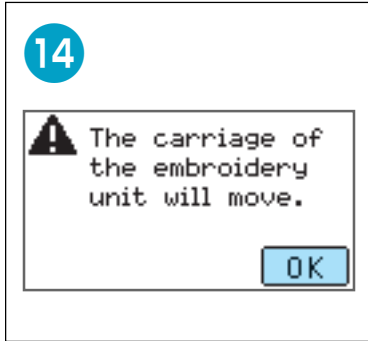
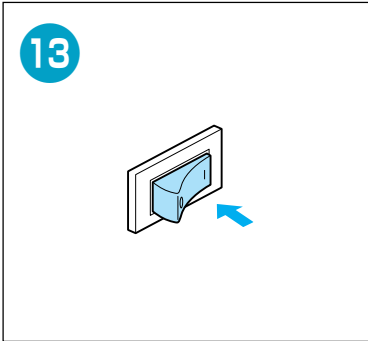

Selecting Embroidery Patterns Wählen von Stickmustern Sélection des motifs de broderie Kiezen van borduurpatronen Selezione degli schemi di ricamo Selección de diseños de bordados

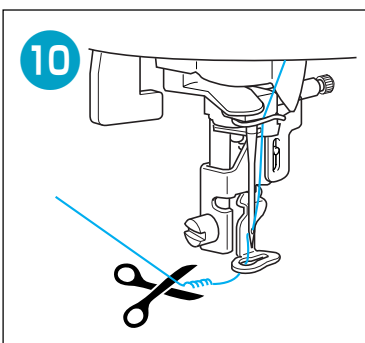
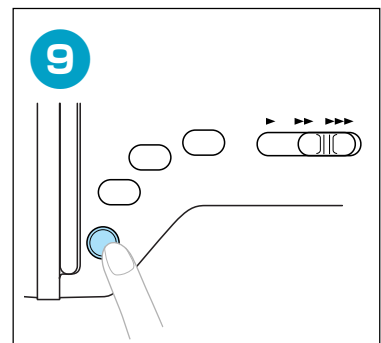
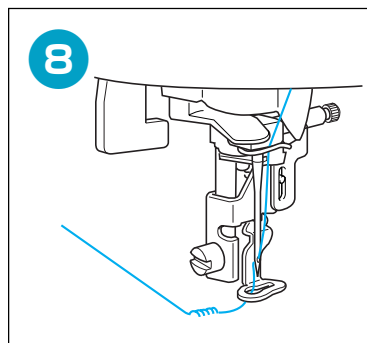
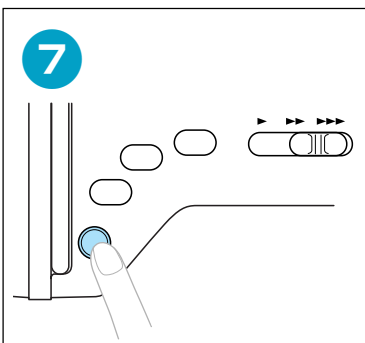
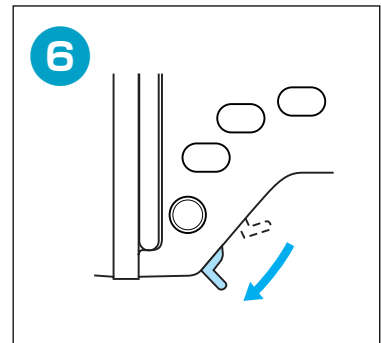
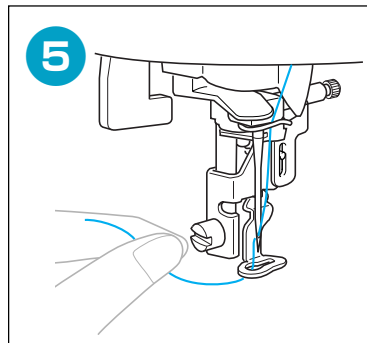
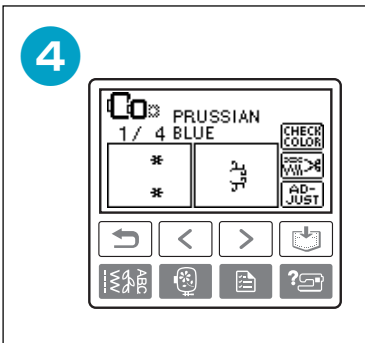
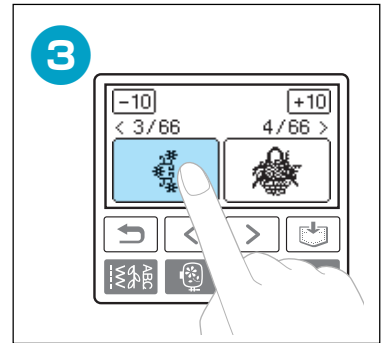
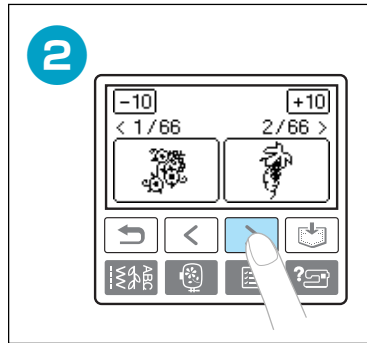
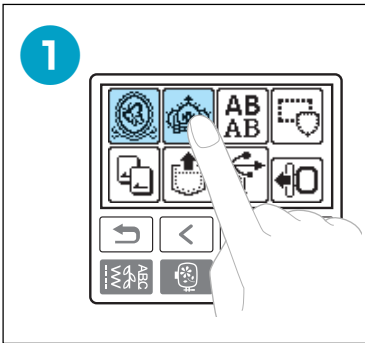

Character Patterns
Zeichenmuster
Motifs de caractères
Karakterpatronen
Schemi con lettere
Tipos de caracteres

ABC

A B C D E F G H I J K L M N O P Q R S
T U V W X Y Z
a b c d e f g h i j k l m n o p q r s
t u v w x y z
0 1 2 3 4 5 6 7 8 9
& ? ! - _ () ' . , /
Ä Å Æ Æ Ñ Ö Ø Ç Ü
ä à á â ã æ ë è é ê ñ ö ò ø ì ç ü ù ß

ABC

A B C D E F G H I J K L M N O P Q R S
T U V W X Y Z
a b c d e f g h i j k l m n o p q r s
t u v w x y z
0 1 2 3 4 5 6 7 8 9
& ? ! - _ () ' . , /
Ä Å Æ Æ Ñ Ö Ø Ç Ü
ä à á â ã æ ë è é ê ñ ö ò ø ì ç ü ù ß

ABC

A B C D E F G H I J K L M N O P Q R S
T U V W X Y Z
a b c d e f g h i j k l m n o p q r s
t u v w x y z
0 1 2 3 4 5 6 7 8 9
& ? ! - _ () ' . , /
Ä Å Æ Æ Ñ Ö Ø Ç Ü
ä à á â ã æ ë è é ê ñ ö ò ø ì ç ü ù ß

ABC

A B C D E F G H I J K L M N O P Q R S
T U V W X Y Z
a b c d e f g h i j k l m n o p q r s
t u v w x y z
0 1 2 3 4 5 6 7 8 9
& ? ! - _ () ' . , /
Ä Å Æ Æ Ñ Ö Ø Ç Ü
ä å æ è é ê ë ñ ö ø ì ç ü ù ß

ABC

A B C D E F G H I J K L M N O P Q R S
T U V W X Y Z
a b c d e f g h i j k l m n o p q r s
t u v w x y z
0 1 2 3 4 5 6 7 8 9
& ? ! - _ () ' . , /
Ä Å Æ Æ Ñ Ö Ø Ç Ü
ä å æ è é ê ë ñ ö ø ì ç ü ù ß

ABC

A B C D E F G H I J K L M N O P Q R S
T U V W X Y Z
a b c d e f g h i j k l m n o p q r s
t u v w x y z
0 1 2 3 4 5 6 7 8 9
& ? ! - _ () ' . , /
Ä Å Æ Æ Ñ Ö Ø Ç Ü
ä å æ è é ê ë ñ ö ø ì ç ü ù ß

Frame patterns Rahmenmuster Motifs cadres Kaderpatronen Motivi a cornicetta Costuras de encuadre



- Frame shapes ■ Rahmen-Formen ■ Formes de cadre
- Raamvormen ■ Forme cornici ■ Tipos de bastidores

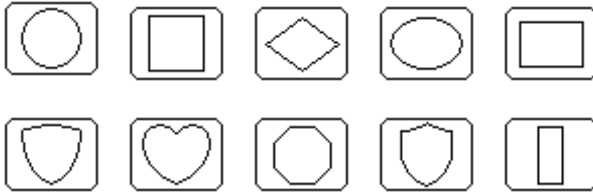

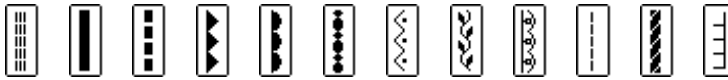

- Stitches ■ Stiche ■ Points
- Steken ■ Punti ■ Puntadas



- Sample at actual size ■ Muster in Originalgröße ■ Exemple en vraie grandeur
- Voorbeeld op ware grootte ■ Campione in dimensioni reali ■ Muestra en tamaño real

Sample combining  and  / Muster mit Kombination von  und  /

Exemple combinant  et  / Voorbeeld waarin  en  zijn gecombineerd /

Campione che combina  e  / Muestra combinando  y  /

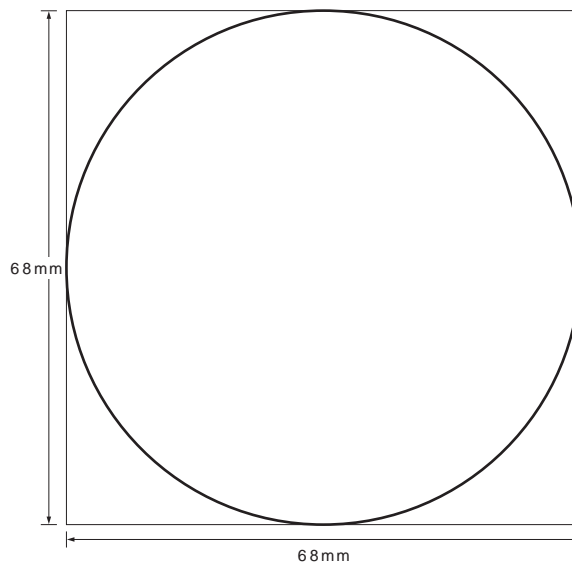



Embroidery Pattern Color Change Table Stickmuster-Farbtabelle

No. 1- Tableau de changement de couleur des motifs de broderie
No. 70 Kleurwijzigingstabel voor de borduurpatronen
Tabella di cambiamento colori degli schemi di ricamo
Tabla de cambio de color para patrones de bordado



No.1

8min	
1	(502)
2	(019)
3	(205)
4	(208)

Size
↓9.5cm ↔7.1cm



No.6

4min	
1	(485)
2	(473)
3	(264)
4	(322)
5	(334)
6	(000)
7	(133)

Size
↓2.0cm ↔9.5cm

COUNTRY (C)



No.11

2min	
1	(124)
2	(027)

Size
↓3.8cm ↔4.1cm



No.2

11min	
1	(086)
2	(843)
3	(058)
4	(010)
5	(205)

Size
↓5.7cm ↔7.7cm



No.7

8min	
1	(502)
2	(010)
3	(208)

Size
↓7.3cm ↔6.0cm



No.12

3min	
1	(205)
2	(502)
3	(070)

Size
↓3.6cm ↔5.2cm



No.3

16min	
1	(502)
2	(612)
3	(070)
4	(010)
5	(007)

Size
↓7.4cm ↔7.4cm



No.8

2min	
1	(800)
2	(507)
3	(900)

Size
↓2.6cm ↔2.9cm



No.13

2min	
1	(810)

Size
↓5.5cm ↔4.1cm



No.4

1min	
1	(800)
2	(507)

Size
↓2.9cm ↔1.9cm



No.9

2min	
1	(027)
2	(810)
3	(620)

Size
↓2.3cm ↔4.0cm



No.14

6min	
1	(804)
2	(027)
3	(804)
4	(206)

Size
↓9.1cm ↔8.9cm



No.5

2min	
1	(507)
2	(513)
3	(205)
4	(339)

Size
↓3.8cm ↔4.3cm



No.10

3min	
1	(534)
2	(800)
3	(307)
4	(030)

Size
↓2.7cm ↔4.1cm



No.15

16min	
1	(513)
2	(534)
3	(612)
4	(620)
5	(070)
6	(010)

Size
↓9.6cm ↔8.6cm

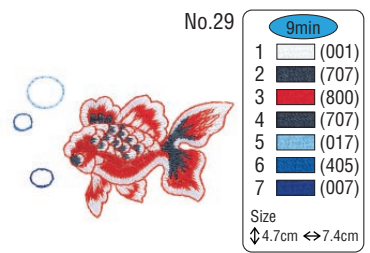
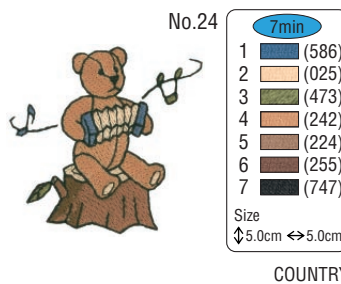
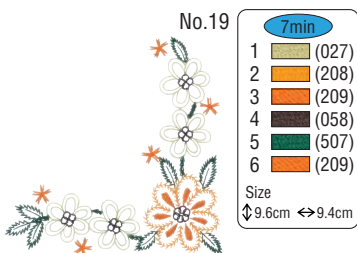
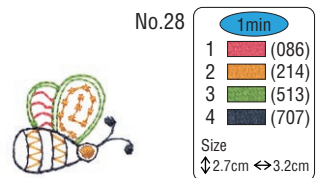
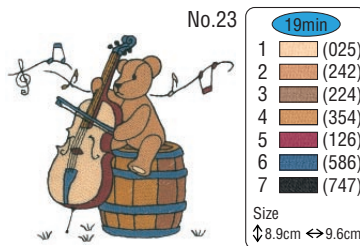
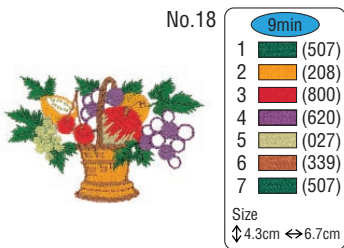
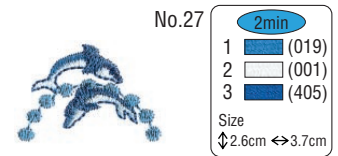
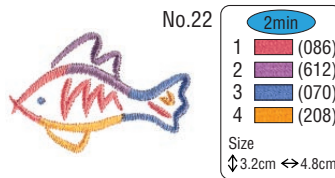
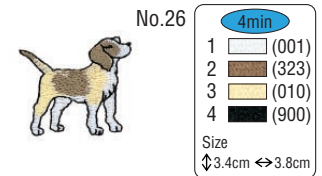
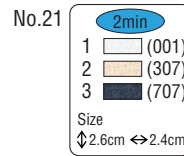
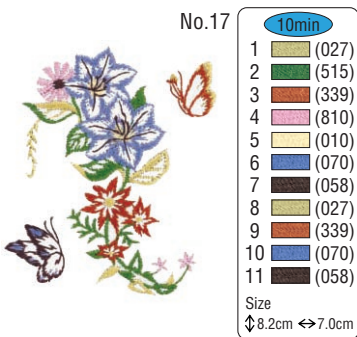
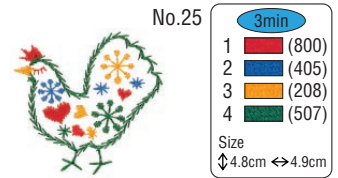
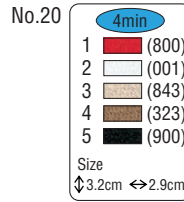
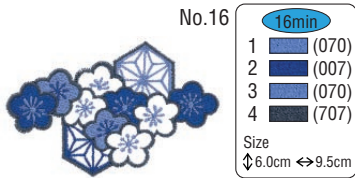

COUNTRY

COUNTRY

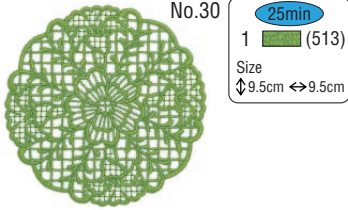

No.30

25min
1 (513)
Size
9.5cm ↔ 9.5cm



No.35

13min
1 (810)
Size
7.4cm ↔ 9.6cm



No.40

21min
1 (152)
2 (158)
3 (126)
4 (024)
5 (155)
6 (158)
7 (024)
8 (126)
Size
9.5cm ↔ 9.5cm

COUNTRY



No.31

4min
1 (810)
Size
4.8cm ↔ 8.5cm



No.36

6min
1 (019)
2 (405)
3 (019)
4 (208)
Size
6.8cm ↔ 6.0cm



No.41

7min
1 (158)
Size
15.6cm ↔ 12.3cm

COUNTRY



No.32

2min
1 (810)
Size
3.4cm ↔ 3.5cm



No.37

3min
1 (209)
2 (205)
3 (058)
4 (405)
5 (800)
Size
6.0cm ↔ 5.0cm



No.42

2min
1 (158)
Size
9.4cm ↔ 4.2cm

COUNTRY



No.33

3min
1 (017)
2 (079)
Size
5.7cm ↔ 3.8cm



No.38

6min
1 (586)
2 (575)
3 (706)
Size
9.6cm ↔ 2.5cm

COUNTRY

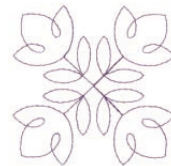

No.43

1min
1 (620)
Size
7.1cm ↔ 7.1cm



No.34

12min
1 (612)
Size
9.6cm ↔ 6.2cm



No.39

11min
1 (473)
2 (485)
3 (354)
4 (444)
5 (463)
Size
9.5cm ↔ 9.5cm

COUNTRY



No.44

1min
1 (620)
Size
5.7cm ↔ 5.7cm

Embroidery Pattern Color Change Table
Stickmuster-Farbtabelle
Tableau de changement de couleur des motifs de broderie
Kleurwijzigingstabel voor de borduurpatronen
Tabella di cambiamento colori degli schemi di ricamo
Tabla de cambio de color para patrones de bordado

No.45



8min	
1	(152)
2	(444)
3	(717)
4	(255)
5	(354)
6	(446)
7	(444)

Size
 ↓7.6cm ↔8.2cm

COUNTRY

No.49

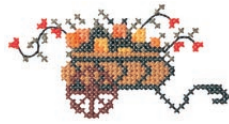

7min	
1	(334)
2	(322)
3	(335)
4	(336)
5	(473)
6	(354)
7	(485)
8	(148)
9	(255)

Size
 ↓4.8cm ↔9.4cm

COUNTRY

No.53

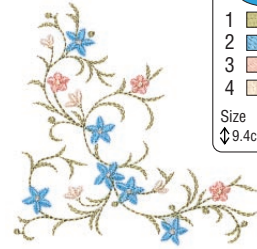

7min	
1	(027)
2	(017)
3	(124)
4	(307)

Size
 ↓9.4cm ↔9.5cm

No.46



19min	
1	(706)
2	(354)
3	(264)
4	(122)
5	(133)
6	(335)
7	(444)
8	(446)
9	(485)
10	(126)
11	(255)
12	(512)

Size
 ↓9.2cm ↔9.0cm

COUNTRY

No.50



2min	
1	(149)
2	(370)
3	(334)
4	(133)
5	(624)
6	(322)
7	(717)
8	(485)

Size
 ↓2.8cm ↔5.4cm

COUNTRY

No.54



2min	
1	(027)
2	(124)
3	(017)
4	(307)

Size
 ↓3.0cm ↔9.4cm

No.47



11min	
1	(025)
2	(224)
3	(473)
4	(155)
5	(485)
6	(149)

Size
 ↓9.4cm ↔8.2cm

COUNTRY

No.51

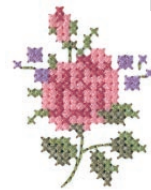

4min	
1	(024)
2	(152)
3	(444)
4	(473)
5	(623)

Size
 ↓5.3cm ↔4.0cm

COUNTRY

No.55



3min	
1	(079)
2	(124)

Size
 ↓4.6cm ↔3.2cm

No.48

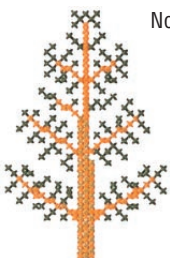

5min	
1	(446)
2	(335)
3	(404)

Size
 ↓9.0cm ↔5.8cm

COUNTRY

No.52



1min	
1	(025)
2	(155)
3	(483)
4	(158)

Size
 ↓1.6cm ↔2.2cm

COUNTRY

No.56



3min	
1	(208)
2	(612)
3	(010)
4	(027)
5	(206)
6	(058)

Size
 ↓2.9cm ↔3.8cm

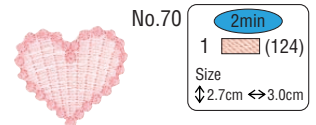
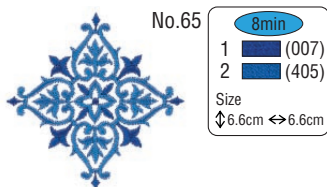
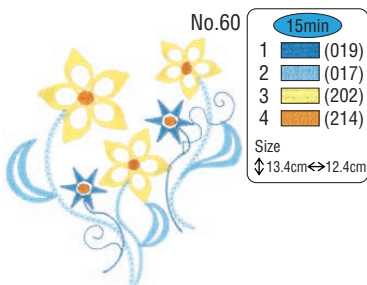
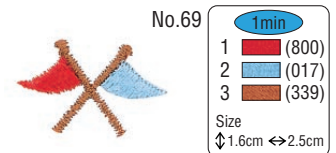
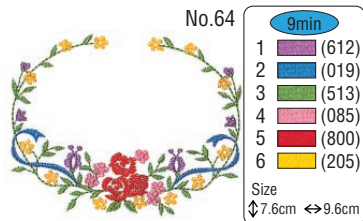
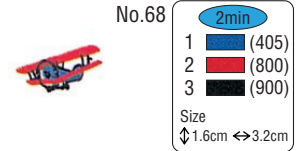
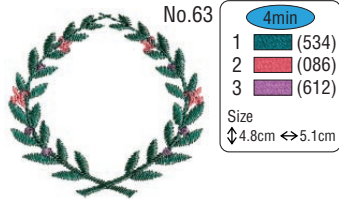
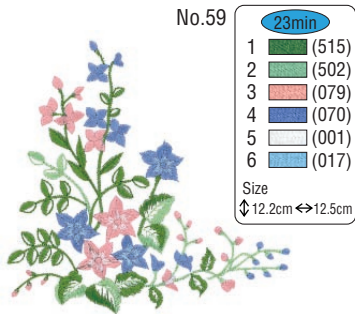
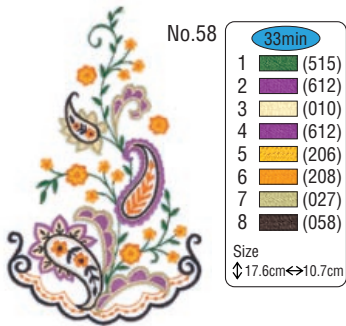
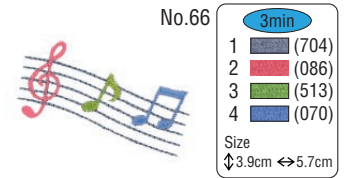
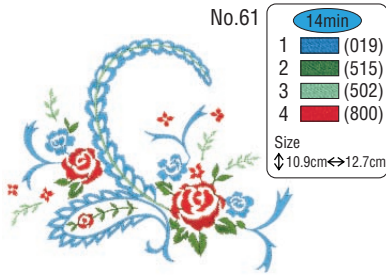
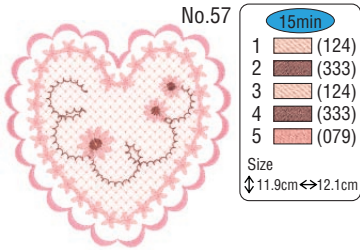



Embroidery Pattern Color Change Table Stickmuster-Farbtabelle

No. 1- Tableau de changement de couleur des motifs de broderie
No. 66 Kleurwijzigingstabel voor de borduurpatronen
Tabella di cambiamento colori degli schemi di ricamo
Tabla de cambio de color para patrones de bordado

No.1

7min

1	(206)
2	(027)
3	(804)
4	(812)

Size
↓6.4cm ↔ 6.6cm

No.2

4min

1	(070)
---	-------

Size
↓7.9cm ↔ 4.7cm

No.3

2min

1	(007)
2	(405)
3	(800)
4	(070)

Size
↓5.2cm ↔ 2.9cm

No.4

4min

1	(323)
2	(507)
3	(800)
4	(214)

Size
↓2.8cm ↔ 3.2cm

No.5

2min

1	(019)
---	-------

Size
↓2.2cm ↔ 4.3cm

No.6

4min

1	(079)
---	-------

Size
↓4.9cm ↔ 6.6cm

No.7

25min

1	(473)
2	(444)
3	(463)
4	(473)
5	(354)
6	(158)
7	(322)
8	(336)
9	(264)
10	(322)
11	(336)
12	(264)
13	(444)
14	(706)

Size
↓9.6cm ↔ 9.4cm

COUNTRY

No.8

5min

1	(007)
---	-------

Size
↓4.6cm ↔ 8.5cm

No.9

3min

1	(007)
---	-------

Size
↓3.9cm ↔ 8.1cm

No.10

2min

1	(214)
---	-------

Size
↓3.0cm ↔ 5.7cm

No.11

5min

1	(214)
2	(019)
3	(027)

Size
↓5.2cm ↔ 5.2cm

No.12

3min

1	(070)
2	(607)
3	(070)

Size
↓9.6cm ↔ 3.0cm

No.13

3min

1	(476)
2	(126)
3	(024)
4	(122)

Size
↓8.1cm ↔ 1.6cm

COUNTRY

No.14

4min

1	(328)
2	(323)
3	(612)
4	(208)

Size
↓2.2cm ↔ 9.6cm

No.15

9min

1	(328)
2	(323)
3	(612)
4	(208)

Size
↓9.6cm ↔ 9.6cm



No.16

23min

1	(515)
2	(405)
3	(019)
4	(704)
5	(007)

Size
 ↓16.4cm ↔9.9cm

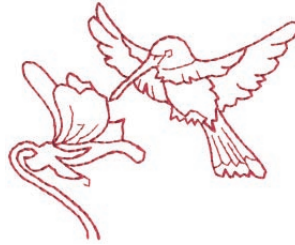

No.20

3min

1	(158)
---	-------

Size
 ↓7.1cm ↔8.7cm

COUNTRY (mm)



No.17

15min

1	(507)
2	(620)
3	(019)
4	(405)
5	(209)
6	(800)

Size
 ↓15.7cm ↔7.2cm



No.21

4min

1	(086)
---	-------

Size
 ↓7.1cm ↔4.5cm



No.22

9min

1	(001)
2	(208)
3	(017)
4	(612)
5	(070)
6	(707)
7	(900)

Size
 ↓3.9cm ↔5.7cm



No.18

18min

1	(323)
2	(502)
3	(515)
4	(079)
5	(085)
6	(208)

Size
 ↓13.6cm ↔10.0cm



No.23

18min

1	(513)
2	(001)
3	(323)
4	(800)
5	(017)
6	(810)
7	(900)
8	(513)
9	(001)
10	(323)
11	(019)
12	(070)
13	(900)
14	(058)
15	(502)
16	(704)
17	(900)

Size
 ↓9.6cm ↔6.5cm



No.19

7min

1	(017)
---	-------

Size
 ↓5.9cm ↔8.3cm



















No.24

1min

1	(612)
---	-------

Size
 ↓5.8cm ↔9.4cm

Embroidery Pattern Color Change Table
Stickmuster-Farbtabelle
Tableau de changement de couleur des motifs de broderie
Kleurwijzigingstabel voor de borduurpatronen
Tabella di cambiamento colori degli schemi di ricamo
Tabla de cambio de color para patrones de bordado

<p>No.25</p>  <p>2min 1 (612) Size ↓17.6cm ↔ 5.7cm</p>	<p>No.30</p>  <p>4min 1 (604) 2 (334) 3 (155) Size ↓5.8cm ↔ 3.6cm</p> <p>COUNTRY</p>	<p>No.36</p>  <p>5min 1 (507) 2 (208) 3 (001) 4 (307) 5 (800) 6 (339) Size ↓4.2cm ↔ 4.9cm</p>
<p>No.26</p>  <p>2min 1 (612) Size ↓12.6cm ↔ 12.6cm</p>	<p>No.31</p>  <p>3min 1 (800) 2 (001) 3 (900) 4 (019) 5 (205) 6 (323) Size ↓3.0cm ↔ 2.1cm</p>	<p>No.37</p>  <p>10min 1 (800) 2 (030) 3 (507) 4 (070) 5 (005) 6 (070) 7 (900) 8 (328) Size ↑5.5cm ↔ 9.3cm</p>
<p>No.27</p>  <p>4min 1 (070) 2 (079) Size ↓6.9cm ↔ 6.3cm</p>	<p>No.32</p>  <p>3min 1 (005) 2 (323) 3 (058) 4 (900) 5 (323) 6 (005) Size ↓2.9cm ↔ 2.9cm</p>	<p>No.38</p>  <p>8min 1 (586) 2 (485) 3 (473) 4 (149) 5 (334) Size ↓5.5cm ↔ 9.0cm</p> <p>COUNTRY</p>
<p>No.28</p>  <p>4min 1 (323) Size ↓10.0cm ↔ 6.5cm</p>	<p>No.33</p>  <p>2min 1 (704) Size ↓2.3cm ↔ 3.0cm</p>	<p>No.39</p>  <p>4min 1 (588) 2 (000) 3 (126) 4 (024) 5 (255) 6 (354) 7 (586) Size ↓3.4cm ↔ 8.1cm</p> <p>COUNTRY</p>
<p>★ No.29</p>  <p>2min 1 (086) 2 (086) 3 (086) 4 (328) Size ↓4.9cm ↔ 4.8cm</p>	<p>No.34</p>  <p>2min 1 (001) 2 (405) 3 (017) 4 (800) Size ↓3.2cm ↔ 3.3cm</p>	<p>No.40</p>  <p>16min 1 (507) 2 (007) 3 (405) 4 (810) 5 (085) 6 (001) 7 (800) 8 (900) 9 (208) Size ↓9.6cm ↔ 6.3cm</p>
<p>No.35</p>  <p>4min 1 (001) 2 (843) 3 (707) 4 (900) Size ↓4.0cm ↔ 2.7cm</p>		



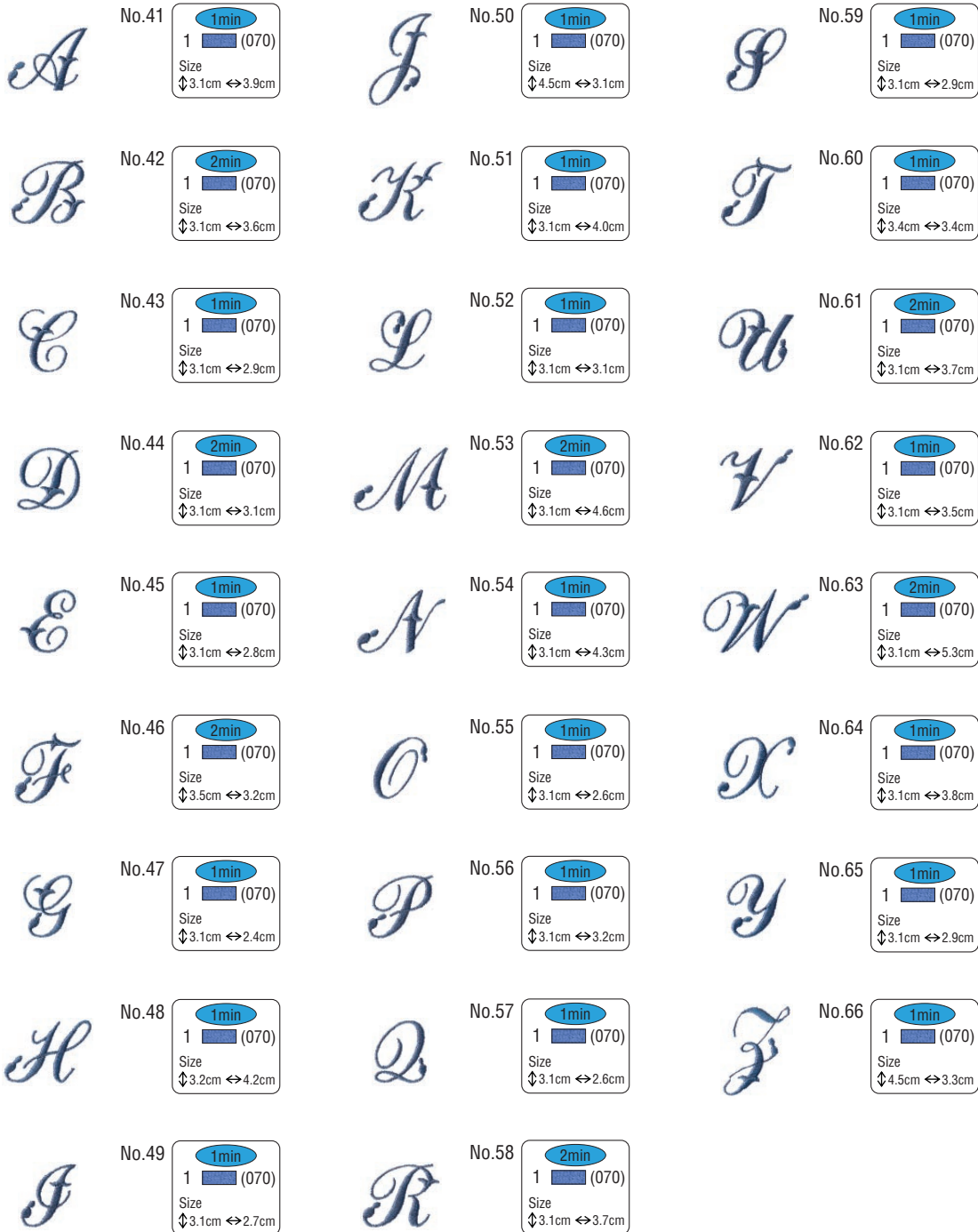

- ★ Refer to the operation manual for the sewing machine for details on how to embroider appliqués.
- ★ Für Einzelheiten zum Sticken der Applikationen wird auf die Bedienungsanleitung der Nähmaschine verwiesen.
- ★ Se reporter au mode d'emploi de la machine à coudre pour la façon de broder les appliqués.
- ★ Zie de bedieningshandleiding van de naaimachine voor nadere bijzonderheden betreffende het borduren van de appliqués.
- ★ Per istruzioni dettagliate sul ricamo delle applique consultare il manuale d'istruzioni della macchina per cucire.
- ★ Consulte el manual de instrucciones de la máquina de coser para los detalles sobre cómo bordar los apliques.



Color Thread Conversion Chart Stickgarn-Farbtabelle











































Tableau de conversion des fils de couleur Omzettingstabel voor kleurgaren

Tabella di conversione dei fili colorati Tabla de conversión de hilos de color

	Color Name	Embroidery	Country	Madeira Polyneon	Madeira Rayon	Sulky Rayon	R.A. Polyester
1	Black / Schwarz / Noir / Zwart / Nero / Negro	 900	 100	1800	1000	1005	5596
2	White / Weiss / Blanc / Wit / Bianco / Blanco	 001	 000	1801	1002	1001	5597
3	Red / Rot / Rouge / Rood / Rosso / Rojo	 800	 149	1637	1037	1037	5678
4	Pink / Rosa / Rose / Rose / Rosa / Rosado	 085	 155	1921	1108	1224	5523
5	Deep Rose / Tiefrot / Rose Fonce / Roserood / Rosa Intenso / Rosa Intenso	 086	 024	1721	1117	1154	9168
6	Flesh Pink / Fleisch Farben / Rose Chair / Lichtrose / Rosa Carne / Rosa Claro	 124	 152	1915	1015	1064	5677
7	Dark Fuchsia / Dunkel Violett / Fuchsia Fonce / Donker Fuchsia Paars / Fuchsia Scuro / Fuschia Oscuro	 107	 126	1984	1383	1533	5804
8	Vermilion / Zinnober Rot / Vermillon / Vermil Joen / Rosso Vermiglio / Bermellon	 030	 148	1779	1179	1184	9023
9	Carmine / Karminrot / Carmin / Karmijn / Rosso Carminio / Carmin	 807	 158	1986	1081	1511	5561
10	Royal Purple / Königs Purpur / Pourpre Royal / Dieppaars / Rosso-Violaceo / Violeta Real	 869	 636	1788	1188	1192	5681
11	Magenta / Magenta / Magenta / Magenta / Magenta / Magenta	 620	 625	1710	1319	1191	5592
12	Salmon Pink / Lachsrosa / Rose Saumon / Zalmrose / Rosa Salmone / Rosa Salmon	 079	 122	1816	1317	1225	5773
13	Amber Red / Bern Steinrot / Rouge Ambre / Amber Rood / Rosso Ambrà / Rojo Ambar	 333	 212	1942	1341	1119	5591
14	Lemon Yellow / Zitronen Gelb / Jaune Citron / Citro Engeel / Giallo Limone / Amarillo Limon	 202	 342	1623	1023	1067	5625
15	Yellow / Gelb / Jaune / Geel / Giallo / Amarillo	 205	 043	1980	1068	1187	5860
16	Harvest Gold / Erntegold / Or Ble / Oogst Kleurig Goud / Giallo Grano / Amarillo Trigo	 206	 334	1971	1024	1124	5770
17	Orange / Orange / Orange / Oranje / Arancio / Naranja	 208	 335	1951	1137	1024	5694
18	Pumpkin / Kürbis Gelb / Ci-Trouille / Pompoen / Giallo Zucca / Calabaza	 126	 322	1952	1155	1065	5630
19	Tangerine / Mandari Nenorange / Tangerine / Felorange / Mandarino / Tangerina	 209	 336	1965	1078	1078	5518
20	Cream Brown / Braun Weiss / Brun Creme / Creme Bruin / Nocciola / Marron Crema	 010	 331	1866	1022	1061	5761
21	Cream Yellow / Gelblich Weiss / Jaune Creme / Cremegeel / Giallo Crema / Amarillo Crema	 812	 370	1861	1349	1135	5564
22	Khaki / Khaki Braun / Kaki / Khaki / Kaki / Caqui	 348	 242	1939	1255	1055	5636
23	Deep Gold / Tiefgold / Or Fonce / Diepgoud / Oro Scuro / Amarillo Oro	 214	 354	1772	1172	1025	5770
24	Brass / Messin G Farben / Cuivre / Koper / Ottone / Bronze	 328	 404	1791	1192	1159	9109
25	Linen / Leinen Farbig / Drap / Linnen / Lino / Lino	 307	 025	1682	1149	1082	5635
26	Dark Brown / Dunkel Braun / Brun Sombre / Donker Bruin / Marrone Scuro / Marron Oscuro	 058	 717	1859	1130	1129	5637
27	Reddish Brown / Rotbraun / Brun Rougeatre / Rassing Bruin / Marrone Bruciato / Marron Rojizo	 337	 264	1753	1253	1021	5781
28	Clay Brown / Lehm Braun / Brun Argile / Kleibruin / Marrone Argilla / Marron Tierra	 339	 224	1621	1021	1158	5590
29	Beige / Beige / Beige / Beige / Beige / Beige	 843	 012	1738	1138	1127	5598
30	Warm Gray / Warmgrau / Gris Vif / Warm Grijs / Grigio Caldo / Gris Caliente	 399	 706	1860	1085	1218	9126
31	Russet Brown / Rotbraun / Brun Roussatre / Roodbruin / Ruggine / Marron Bermejo	 330	 414	1726	1194	1126	5702
32	Light Brown / Hellbraun / Brun Clair / Licht Bruin / Marrone Chiaro / Marron Claro	 323	 255	1729	1056	1128	5789
33	Seacrest / Blassgrün / Vert Pale / Blauw Groen / Cresta Di Mare / Verde Celadon	 542	 505	1647	1219	1077	5578
34	Mint Green / Pfeffer Minzgrün / Vert Menthe / Munt Groen / Verde Menta / Verde Menta	 502	 461	1702	1302	1047	5511
35	Leaf Green / Blattgrün / Vert Feuille / Bladgroen / Verde Prato / Verde De Hoja	 509	 463	1749	1050	1510	5514
36	Olive Green / Olivgrün / Vert Olive / Olijf Groen / Verde Oliva / Verde Oliva	 519	 476	1904	1396	1174	5502
37	Dark Olive / Dunkel Olivgrün / Olive Fonce / Donker Olijf / Oliva Scuro / Verde Oliva Oscuro	 517	 473	1769	1156	1156	9122
38	Teal Green / Blaugrün / Vert Sarcelle / Taling Groen / Verde Anatra / Verde Azulado	 534	 483	1879	1298	1503	5751
39	Emerald Green / Emerald Grün / Vert Emeraude / Smaragd Groen / Verde Smeraldo / Verde Esmeralda	 507	 485	1750	1250	1079	5508
40	Deep Green / Dunkel Grün / Vert Fonce / Diepgroen / Verde Intenso / Verde Intenso	 808	 467	1703	1370	1208	5615

Color Thread Conversion Chart
Tableau de conversion des fils de couleur
Tabella di conversione dei fili colorati

Stickgarn-Farbtabelle
Omzettingstabel voor kleurgaren
Tabla de conversión de hilos de color

		Embroidery	Country	Madeira Polyneon	Madeira Rayon	Sulky Rayon	R.A. Polyster	
41	Fresh Green / Frisch Grün / Vert Frais / Licht Groen / Verde Mela / Verde Fresco	 027	 442	1706	1102	1209	9153	
42	Lime Green / Limonen Grün / Vert Tilleul / Limoen Groen / Verde Tiglio / Verde Lima	 513	 444	1848	1049	1177	5622	
43	Moss Green / Moosgrün / Vert Mousse / Mosgroen / Verde Muschio / Verde Musgo	 515	 446	1770	1369	1176	9091	
44	Blue / Blau / Bleu / Blauw / Azzurro / Azul	 405	 586	1829	1177	1076	5684	
45	Ultra Marine / Ultra Marin / Outremer / Ultra Marijn / Blu Oltremare / Azul De Ultramar	 406	 575	1842	1076	1042	5736	
46	Light Blue / Hellblau / Bleu Clair / Licht Blauw / Celeste / Azul Claro	 017	 150	1932	1132	1074	5683	
47	Sky Blue / Himmel Blau / Bleu Ciel / Hemels Blauw / Azzurro Cielo / Celeste	 019	 512	1828	1029	1196	5506	
48	Electric Blue / Elek-Trisch-Blau / Bleu Élec-Trique / Staal Blauw / Blu Elettrico / Azul Electrico	 420	 564	1797	1297	1250	5829	
49	Peacock Blue / Pfauen Blau / Bleu Paon / Pauwen Blauw / Blu Pavone / Azul Pavo Real	 415	 057	1652	1252	1206	5810	
50	Prussian Blue / Berliner Blau / Bleu De Prusse / Pruisisch Blauw / Blu De Prussia / Azul De Prusia	 007	 588	1767	1166	1535	5737	
51	Cornflower Blue / Kornblu Menblau / Bleu Centauree / Koren Bloemen Blauw / Blu Fior-Daliso / Azul Centaura	 070	 015	1830	1335	1028	5601	
52	Light Lilac / Helllila / Lilas Clair / Licht Lila / Lilla Chiaro / Lila Suave	 810	 133	1911	1031	1121	9016	
53	Lilac / Lila / Lilas / Lila / Lilla / Lila	 612	 623	1831	1080	1080	9009	
54	Violet / Violet / Violet / Violet / Violetto / Violeta	 613	 624	1631	1033	1194	5588	
55	Purple / Purpur / Pourpre / Paars / Viola / Purpura	 614	 635	1880	1122	1122	5554	
56	Lavender / Lavendel / Lavande / Lavendel / Lavenda / Lavanda	 804	 604	1630	1261	1193	5586	
57	Wisteria Violet / Wistaria Violet / Violet Glycine / Blauwe Regen Paars / Glicine / Violeta Vistaria	 607	 003	1943	1311	1032	5587	
58	Pewter / Zinngrau / Etain / Tinkleurig / Peltro / Peltre	 704	 745	1840	1041	1041	9114	
59	Dark Gray / Dunkel Grau / Gris Sombre / Donker Grijs / Grigio Scuro / Gris Oscuro	 707	 747	1841	1241	1220	5565	
60	Silver / Silber / Argent / Zilver / Argento / Plata	 005	 020	1812	1087	1011	5640	
61	Gray / Grau / Gris / Grijs / Grigio / Gris	 817	 734	1640	1118	1219	5782	
62		----->						
63		-----						
64		~~~~~ TTTTTTTTTTTTTTTT						
65	NOT DEFINED / NICHT DEFINIERT / NON DEFINI / NIET GEDEFINIEERD / NON DEFINITO / SIN DEFINIR							

Note: The conversion chart is based on Embroidery thread. The color shades may vary with the different brands listed on the chart. If unsure of a particular color(s), please sew test. Robison Anton, Isacord, Maderia, Sulky and Güetermann are respectively registered trademarks. Actual colors may vary slightly from the chart.

Hinweis: Die Umrechnungstabelle basiert auf dem Stickgarn. Die Farbschattierungen können je nach unterschiedlichen in der Tabelle aufgeführten Marken abweichen. Wenn Sie sich bezüglich bestimmter Farben nicht sicher sind, nähern Sie bitte zur Probe. Robison Anton, Isacord, Maderia, Sulky und Güetermann sind eingetragene Warenzeichen. Die tatsächlichen Farben können leicht von der Tabelle abweichen.

Remarque: Le tableau de conversion est basé sur un fil de broderie. Les nuances de couleur peuvent varier en fonction des marques énumérées dans le tableau. En cas de doute sur un coloris, faites un essai de couture. "Robison Anton", "Isacord", "Maderia", "Sulky" et "Güetermann" sont des marques déposées respectives. Les couleurs réelles risquent d'être légèrement différentes de celles du tableau.

Opmerking: Het omzettingsschema is gebaseerd op het gebruik van borduurzijde. De kleurtinten kunnen ietwat verschillen voor de diverse merken in het schema. Als u niet zeker bent van de juiste kleur(en), borduurt u dan een stukje op proef. De namen Robison Anton, Isacord, Maderia, Sulky en Güetermann zijn allemaal gedeponeerde handelsmerken. De feitelijke kleurtinten kunnen iets afwijken van het getoonde schema.

Nota: la tabella di conversione è in funzione del filo da ricamo. Le tonalità cromatiche possono variare secondo le differenti marche elencate nella tabella. In caso di dubbio su un particolare colore o su più colori si raccomanda di eseguire una prova di cucito. Robison Anton, Isacord, Maderia, Sulky e Güetermann sono marchi di fabbrica registrati. I colori effettivi possono variare lievemente rispetto a quelli della tabella.

Nota: La tabla de conversión está basada en hilo de bordar. Los tonos de color podrán variar con las diferentes marcas listadas en la tabla. Si tiene dudas sobre un color(es) particular, haga un cosido de prueba. "Robison Anton", "Isacord", "Maderia", "Sulky" y "Güetermann" son marcas registradas respectivamente. Los colores verdaderos podrán variar ligeramente con respecto a los de la tabla.