

DISNEY DESIGN GUIDE  
GUIDE DE MODÈLES DISNEY  
GUÍA DE DISEÑO DISNEY

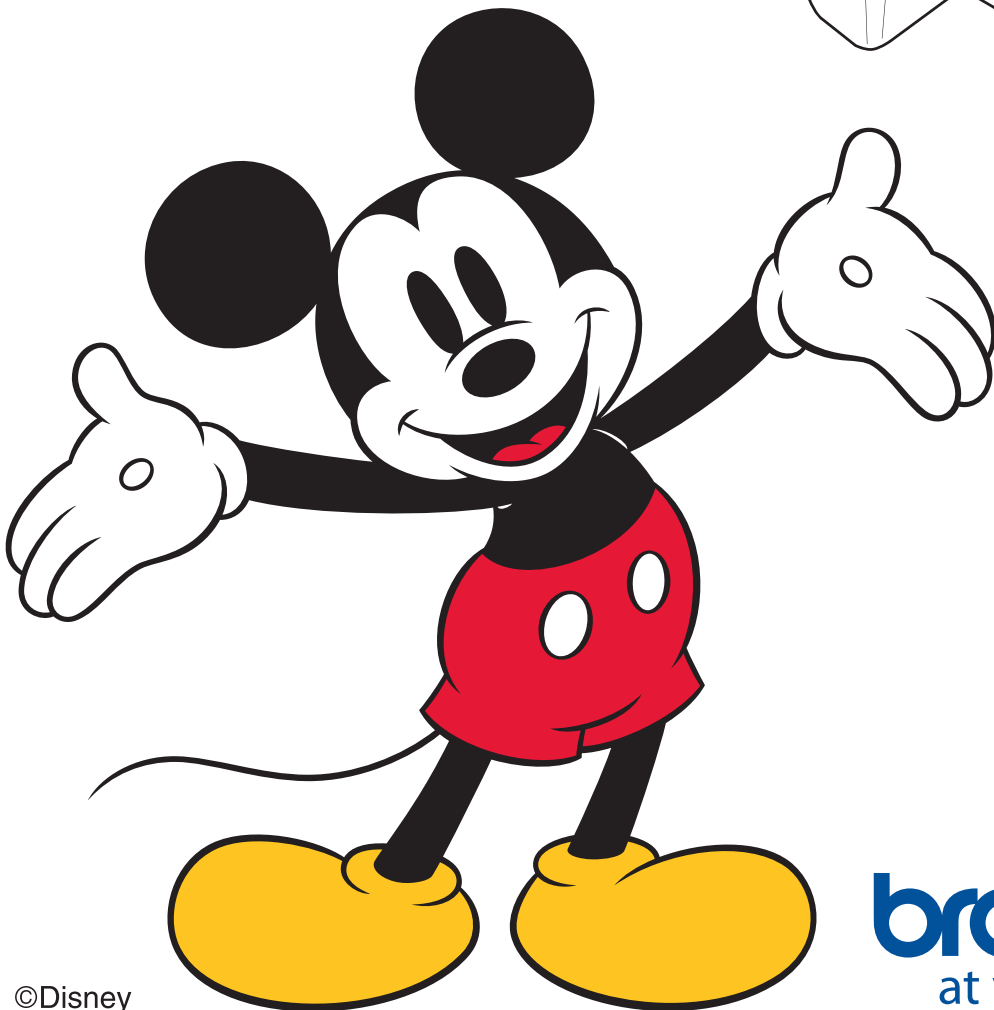
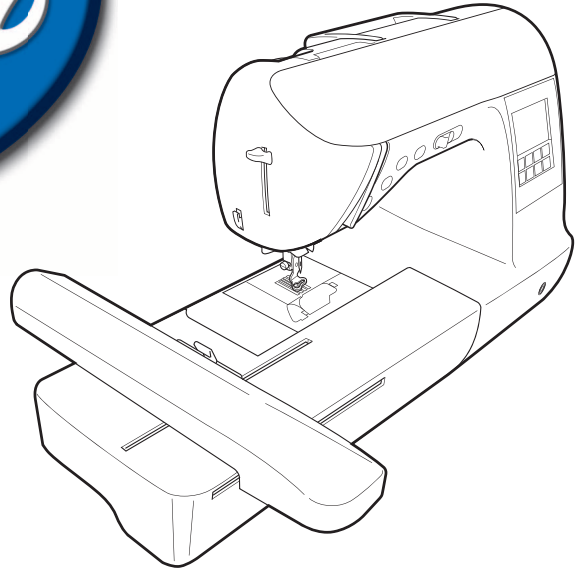

©Disney

**brother**<sup>®</sup>  
at your side

**WARNING**  
**AVERTISSEMENT**  
**ADVERTENCIA**

The embroidery patterns which are pre-programmed into this sewing machine are for personal, private use only. Any commercial or business use is strictly forbidden by copyright laws.

Les motifs de broderie préprogrammés dans cette machine à coudre sont destinés à l'utilisation personnelle seulement. Toute utilisation commerciale est rigoureusement interdite par les lois des droits d'auteur.

Los bordados preprogramados en la máquina de coser son sólo para uso personal y privado. El uso comercial está estrictamente prohibido por las leyes de protección de los derechos de copia.

Refer to the operation manual for detailed instruction.

Also, there are differences in the keys and screens depending on the display language. In this guide, English screens are used for basic explanations.

Pour les instructions détaillées, voir le manuel d'instructions.

Par ailleurs, il y a des différences dans les touches et les écrans en fonction de la langue d'affichage. Dans ce guide, les explications de base utilisent les écrans anglais.

Consulte el manual de instrucciones para ver más detalles.

Además, dependiendo del idioma visualizado algunos botones y pantallas podrán ser diferentes. En esta guía, para las explicaciones básicas se emplean pantallas en inglés.

**Selecting Disney characters**  
**Sélection des personnages Disney**  
**Seleccionando caracteres Disney**

- 1** Turn off the machine before attaching the embroidery unit.  
Mettre la machine hors tension avant de fixer l'unité de broderie.  
Apague la máquina antes de colocar la unidad de bordado.

- Please see the machine's operation manual.
- Se reporter au manuel d'instructions de la machine.
- Consulte el manual de instrucciones de la máquina.

- 2** Once the embroidery unit is correctly attached, turn on the machine.  
Une fois l'unité de broderie correctement fixée, mettre la machine sous tension.  
Una vez la unidad de bordado esté correctamente colocada, encienda la máquina.

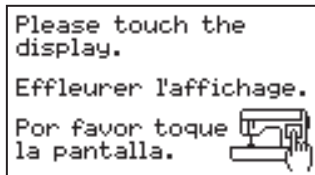

**3** Press **OK** on the LCD screen. The carriage of the embroidery unit will move to the initial setting position.

Appuyer sur **OK** sur l'écran à cristaux liquides. Le chariot de l'unité de broderie se place à la position du réglage initial.

Pulse **OK** en la pantalla LCD. El carro de la unidad de bordado se moverá a la posición de ajuste inicial.

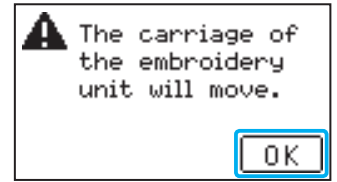

**4** The pattern selections will be displayed as shown at the right.

Press "Mickey".

Les sélections de motifs sont affichées comme indiqué à droite.

Appuyer sur « Mickey ».

Los patrones seleccionados aparecerán en la pantalla tal como se muestra a la derecha.

Toque "Mickey".

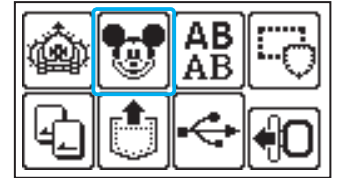

**5** Press the key that corresponds to the desired pattern group.

- ① Standard
- ② Pooh and friends
- ③ Princesses
- ④ Film property
- ⑤ Disney·Pixar

Appuyez sur la touche correspondant au groupe de motifs souhaités.

- ① Standard
- ② L'ourson et ses amis
- ③ Princesses
- ④ Propriété du film
- ⑤ Disney·Pixar

Presione la tecla correspondiente al grupo de patrones deseado.

- ① Normal
- ② Pooh y sus amigos
- ③ Princesas
- ④ Propiedad de la película
- ⑤ Disney·Pixar

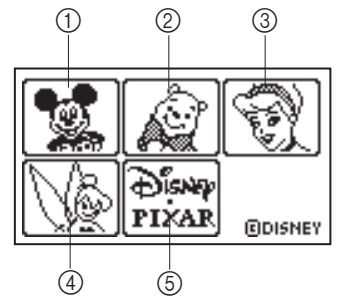

**6** Press the key that corresponds to the desired pattern. The sewing screen will then be displayed.

Appuyer sur la touche correspondant au motif voulu. L'écran de couture apparaît alors.

Toque la tecla que corresponde con el patrón deseado. Se exhibirá la pantalla de costura.

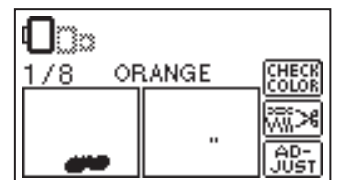
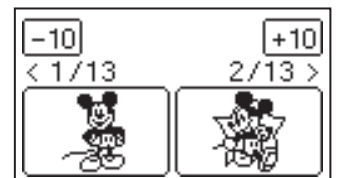

## Color change table Tableau des changements de couleur Tabla de cambio de color

- The numbers in the top shaded area indicate the estimated time needed for the pattern to be embroidered. They do not include the time required to change threads.
- Les chiffres indiqués dans la zone supérieure du tableau indiquent l'estimation de la durée nécessaire pour broder le motif. Ils ne prennent pas en compte le temps nécessaire pour changer les fils.
- Los números sombreados situados en la parte superior indican el tiempo estimado necesario para bordar el patrón. No incluye el tiempo necesario para cambiar los hilos.

Refer to the operation manual for details on how to embroider the pattern.  
Se reporter au manuel d'instructions pour les détails concernant la façon de broder le motif.  
Consulte el manual de instrucciones por detalles sobre como bordar el patrón.

Note: The Disney character patterns built into this unit cannot be resized or flipped.

Remarque : Les motifs des personnages de Disney intégrés dans l'unité ne peuvent être ni redimensionnés ni orientés différemment.

Nota: Los diseños de personajes de Disney incorporados en esta unidad no podrán ser cambiados de tamaño ni darles la vuelta.

- The products in this guide are creations of Brother Industries (K.K.) using the Disney Copyright under contract with Walt Disney Enterprises (Inc.).
- Les produits décrits dans ce guide ont été créés par Brother Industries (K.K.) en utilisant les droits d'auteur de Disney sous contrat de Walt Disney Enterprises (Inc.).
- Los productos en este guía son creaciones de Brother Industries (K.K.) que usan los derechos de autor de Disney mediante contrato con Walt Disney Enterprises (Inc.).

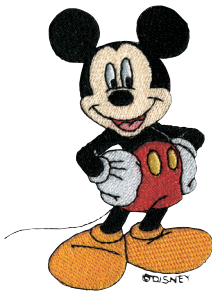

**No.1** 19 min

Order to embroider  
Séquence pour broder  
Orden para el bordador

1	(208)
2	(205)
3	(800)
4	(001)
5	(079)
6	(307)
7	(900)
8	(001)

Embroidery size  
Taille de la broderie  
Tecla de tamaño

↕ 10.4 cm ↔ 7.7 cm

Time required for embroidering  
Durée requise pour broder  
Tiempo requerido para el bordado

Embroidery thread color number  
Numéro de couleur du fil de broderie  
Número de color del hilo de bordado

Embroidery thread color  
Couleur du fil de broderie  
Color del hilo de bordado

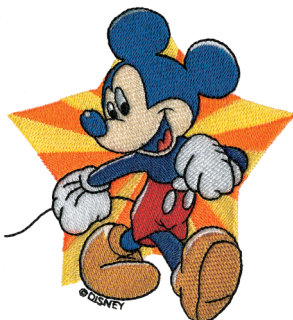

**No.2** 37 min

1	(205)
2	(209)
3	(405)
4	(030)
5	(001)
6	(307)
7	(405)
8	(800)
9	(214)
10	(900)

↕ 11.5 cm ↔ 10.6 cm



**No.3** 19 min

1	(001)
2	(307)
3	(019)
4	(085)
5	(900)
6	(001)

↕ 10.9 cm ↔ 5.9 cm



No.4

19 min	
1	(017)
2	(001)
3	(079)
4	(214)
5	(205)
6	(208)
7	(405)
8	(800)
9	(900)

↓ 9.9 cm ↔ 7.9 cm



No.8

10 min	
1	(001)
2	(307)
3	(079)
4	(800)
5	(900)

↓ 5.5 cm ↔ 5.9 cm

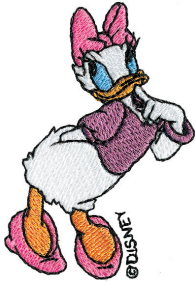

No.5

14 min	
1	(017)
2	(001)
3	(612)
4	(208)
5	(085)
6	(900)

↓ 9.9 cm ↔ 6.7 cm

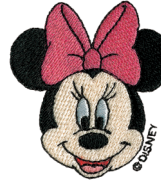

No.9

12 min	
1	(001)
2	(307)
3	(079)
4	(800)
5	(086)
6	(900)

↓ 6.3 cm ↔ 5.7 cm



No.10

7 min	
1	(017)
2	(001)
3	(079)
4	(214)
5	(208)
6	(405)
7	(900)

↓ 5.1 cm ↔ 3.6 cm



No.6

16 min	
1	(800)
2	(079)
3	(001)
4	(507)
5	(214)
6	(900)

↓ 9.9 cm ↔ 10.3 cm



No.11

6 min	
1	(017)
2	(001)
3	(079)
4	(214)
5	(208)
6	(085)
7	(900)

↓ 5.0 cm ↔ 3.2 cm



No.7

29 min	
1	(001)
2	(800)
3	(079)
4	(307)
5	(513)
6	(209)
7	(405)
8	(058)
9	(900)

↓ 14.9 cm ↔ 10.9 cm



No.12

6 min	
1	(001)
2	(800)
3	(079)
4	(214)
5	(900)

↓ 5.6 cm ↔ 2.7 cm



No.13

8 min	
1	(001)
2	(307)
3	(800)
4	(079)
5	(513)
6	(900)

↓ 6.9 cm ↔ 3.5 cm





No.1

13 min

- 1 (214)
- 2 (323)
- 3 (800)
- 4 (900)

↓ 8.7 cm ↔ 4.7 cm

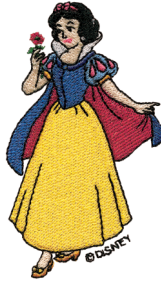

No.1

17 min

- 1 (307)
- 2 (208)
- 3 (205)
- 4 (001)
- 5 (107)
- 6 (086)
- 7 (019)
- 8 (405)
- 9 (086)
- 10 (900)
- 11 (001)
- 12 (507)
- 13 (107)

↓ 9.9 cm ↔ 5.6 cm

No.4

11 min

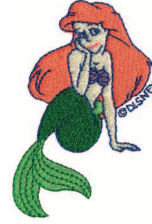

- 1 (001)
- 2 (307)
- 3 (030)
- 4 (502)
- 5 (507)
- 6 (612)
- 7 (086)
- 8 (007)

↓ 7.9 cm ↔ 5.2 cm

No.2

4 min



- 1 (085)
- 2 (124)
- 3 (086)
- 4 (900)

↓ 5.8 cm ↔ 2.8 cm

No.2

20 min



- 1 (307)
- 2 (205)
- 3 (017)
- 4 (001)
- 5 (019)
- 6 (086)
- 7 (007)

↓ 9.9 cm ↔ 8.1 cm

No.3

16 min



- 1 (010)
- 2 (124)
- 3 (209)
- 4 (900)

↓ 8.6 cm ↔ 5.7 cm

No.5

45 min

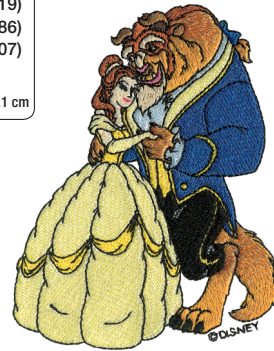

- 1 (214)
- 2 (001)
- 3 (307)
- 4 (010)
- 5 (405)
- 6 (058)
- 7 (323)
- 8 (085)
- 9 (843)
- 10 (339)
- 11 (205)
- 12 (086)
- 13 (900)
- 14 (001)

↓ 12.2 cm ↔ 9.6 cm

No.4

22 min

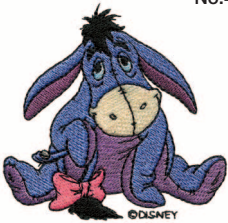

- 1 (001)
- 2 (307)
- 3 (005)
- 4 (086)
- 5 (620)
- 6 (612)
- 7 (070)
- 8 (900)

↓ 7.8 cm ↔ 7.9 cm

No.3

16 min



- 1 (086)
- 2 (085)
- 3 (001)
- 4 (507)
- 5 (307)
- 6 (205)
- 7 (214)
- 8 (323)
- 9 (800)
- 10 (085)
- 11 (058)

↓ 10.8 cm ↔ 6.2 cm

No.5

11 min

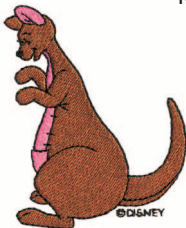

- 1 (085)
- 2 (339)
- 3 (900)

↓ 8.1 cm ↔ 6.6 cm

No.6

14 min



- 1 (001)
- 2 (307)
- 3 (027)
- 4 (017)
- 5 (534)
- 6 (502)
- 7 (214)
- 8 (030)
- 9 (900)
- 10 (001)

↓ 8.1 cm ↔ 7.6 cm

No.6

5 min



- 1 (800)
- 2 (205)
- 3 (507)
- 4 (085)
- 5 (070)
- 6 (339)
- 7 (900)

↓ 3.5 cm ↔ 4.6 cm



No.1



9 min	
1	(017)
2	(019)
3	(307)
4	(502)
5	(001)
6	(205)
7	(086)
8	(900)

↓8.5 cm ↔ 4.9 cm

No.5

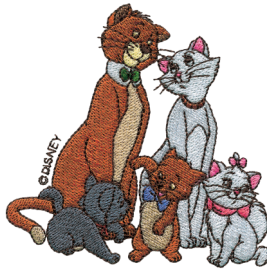

29 min	
1	(843)
2	(010)
3	(001)
4	(085)
5	(323)
6	(339)
7	(704)
8	(800)
9	(070)
10	(086)
11	(515)
12	(058)

↓9.2 cm ↔ 9.5 cm



No.1

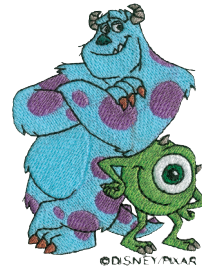

23 min	
1	(001)
2	(005)
3	(339)
4	(612)
5	(507)
6	(017)
7	(513)
8	(534)
9	(900)

↓9.5 cm ↔ 7.1 cm

No.2



12 min	
1	(515)
2	(513)
3	(058)
4	(214)
5	(001)
6	(307)
7	(030)
8	(339)
9	(507)
10	(900)

↓10.3 cm ↔ 4.4 cm

No.6



21 min	
1	(001)
2	(843)
3	(079)
4	(704)
5	(307)
6	(214)
7	(339)
8	(019)
9	(328)
10	(058)

↓9.6 cm ↔ 6.9 cm

No.2

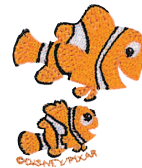

10 min	
1	(001)
2	(208)
3	(214)
4	(900)
5	(001)
6	(208)
7	(214)
8	(900)

↓5.8 cm ↔ 5.1 cm

No.3



18 min	
1	(001)
2	(307)
3	(019)
4	(085)
5	(205)
6	(086)
7	(058)
8	(900)

↓8.1 cm ↔ 8.6 cm

No.7

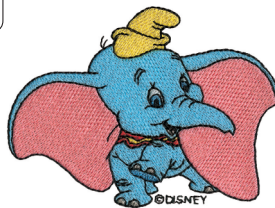

22 min	
1	(005)
2	(001)
3	(019)
4	(205)
5	(079)
6	(017)
7	(800)
8	(124)
9	(900)

↓7.2 cm ↔ 9.7 cm

No.3



18 min	
1	(214)
2	(900)
3	(707)
4	(005)
5	(704)
6	(800)
7	(707)
8	(058)
9	(513)
10	(707)
11	(208)
12	(001)
13	(900)
14	(707)
15	(019)

↓7.7 cm ↔ 6.9 cm

No.4



37 min	
1	(124)
2	(001)
3	(800)
4	(019)
5	(208)
6	(900)

↓12.5 cm ↔ 10.5 cm

