

brother[®]

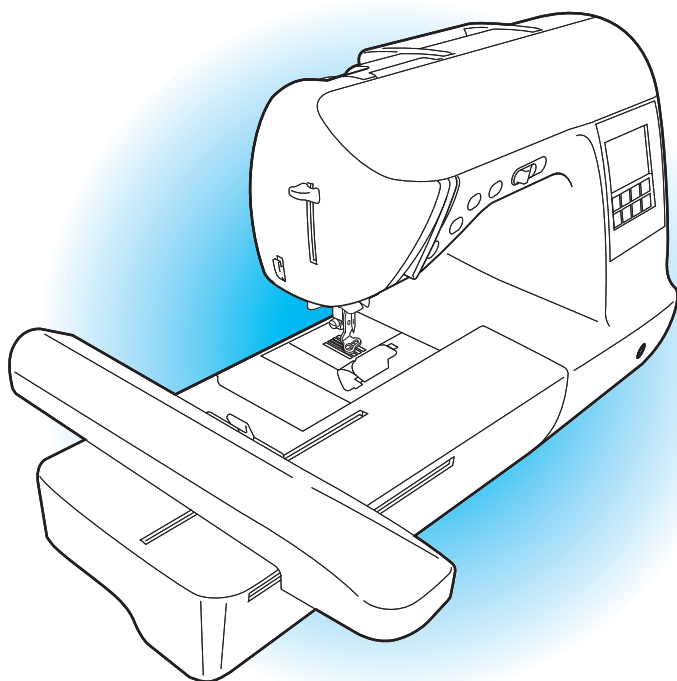

GETTING READY

1

SEWING BASICS

2

UTILITY STITCHES

3

EMBROIDERY

4

APPENDIX

5

Computerized Embroidery and Sewing Machine

Operation Manual

IMPORTANT SAFETY INSTRUCTIONS

Please read these safety instructions before attempting to use the machine.

DANGER - To reduce the risk of electric shock:

- 1 Always** unplug the machine from the electrical outlet immediately after using, when cleaning, when making any user servicing adjustments mentioned in this manual, or if you are leaving the machine unattended.

WARNING - To reduce the risk of burns, fire, electric shock, or injury to persons.

- 2 Always** unplug the machine from the electrical outlet when removing covers, lubricating, or when making any adjustments mentioned in the instruction manual:
 - To unplug the machine, switch the machine to the symbol “O” position to turn it off, then grasp the plug and pull it out of the electrical outlet. **Do not** pull on the cord.
 - Plug the machine directly into the electrical outlet. Do not use an extension cord.
 - **Always** unplug your machine if the power is cut.
- 3 Never** operate this machine if it has a damaged cord or plug, if it is not working properly, if it has been dropped or damaged, or water is spilled on the unit. Return the machine to the nearest authorized dealer or service center for examination, repair, electrical or mechanical adjustment.
 - While the machine is stored or in use if you notice anything unusual, such as an odor, heat, discoloration or deformation, stop using the machine and immediately unplug the power cord.
 - When transporting the sewing machine, be sure to carry it by its handle. Lifting the sewing machine by any other part may damage the machine or result in the machine falling, which could cause injuries.
 - When lifting the sewing machine, be careful not to make any sudden or careless movements, otherwise you may injure your back or knees.
- 4 Always** keep your work area clear:
 - **Never** operate the machine with any air openings blocked. Keep ventilation openings of the sewing machine and foot control free from the build up of lint, dust, and loose cloth.
 - **Do not** store objects on the foot controller.
 - **Do not** use extension cords. Plug the machine directly into the electrical outlet.
 - **Never** drop or insert **any** object into **any** opening.
 - **Do not** operate where aerosol (spray) products are being used or where oxygen is being administered.
 - **Do not** use the machine near a heat source, such as a stove or iron; otherwise, the machine, power cord or garment being sewn may ignite, resulting in fire or an electric shock.
 - **Do not** place this sewing machine on an unstable surface, such as an unsteady or slanted table, otherwise the sewing machine may fall, resulting in injuries.
- 5 Special care** is required when sewing:
 - **Always** pay close attention to the needle. Do not use bent or damaged needles.
 - Keep fingers away from **all** moving parts. Special care is required around the machine needle.
 - Switch the sewing machine to the symbol “O” position to turn it off when making any adjustments in the needle area.
 - **Do not** use a damaged or incorrect needle plate, as it could cause the needle to break.
 - **Do not** push or pull the fabric when sewing, and follow careful instruction when freehand stitching so that you do not deflect the needle and cause it to break.

6 This machine is **not** a toy:

- Your close attention is necessary when the machine is used by or near children.
- The plastic bag that this sewing machine was supplied in should be kept out of the reach of children or disposed of. Never allow children to play with the bag due to the danger of suffocation.
- Do not use outdoors.

7 For a longer service life:

- When storing this machine, avoid direct sunlight and high humidity locations. Do not use or store the machine near a space heater, iron, halogen lamp, or other hot objects.
- Use only neutral soaps or detergents to clean the case. Benzene, thinner, and scouring powders can damage the case and machine, and should never be used.
- Always consult the operation manual when replacing or installing any assemblies, the presser feet, needle, or other parts to assure correct installation.

8 For repair or adjustment:

- If the Light unit (light-emitting diode) is damaged, it must be replaced by authorized dealer.
- In the event a malfunction occurs or adjustment is required, first follow the troubleshooting table in the back of the operation manual to inspect and adjust the machine yourself. If the problem persists, please consult your local authorized Brother dealer.

Use this machine only for its intended use as described in this manual.

Use accessories recommended by the manufacturer as contained in this manual.

The contents of this manual and specifications of this product are subject to change without notice.

For additional product information, visit our web site at www.brother.com

SAVE THESE INSTRUCTIONS

This machine is intended for household use.

FOR USERS IN THE UK, EIRE, MALTA AND CYPRUS ONLY

IMPORTANT

- In the event of replacing the plug fuse, use a fuse approved by ASTA to BS 1362, i.e. carrying the  mark, rating as marked on plug.
- Always replace the fuse cover. Never use plugs with the fuse cover omitted.
- If the available electrical outlet is not suitable for the plug supplied with this equipment, you should contact your authorized dealer to obtain the correct lead.

FOR USERS IN AC INPUT 220-240V COUNTRIES AND MEXICO

This appliance is not intended for use by persons (including children) with reduced physical, sensory or mental capabilities, or lack of experience and knowledge, unless they have been given supervision or instruction concerning use of the appliance by a person responsible for their safety. Children should be supervised to ensure that they do not play with the appliance.

Contents

IMPORTANT SAFETY INSTRUCTIONS	1
Introduction	9
Sewing Machine Features	9
Accessories	10
Included accessories	10
Optional accessories	12
Names of Machine Parts and Their Functions	13
Front view	13
Needle and presser foot section	14
Right-side/rear view	14
Operation buttons	15
Operation panel	16

GETTING READY **17**

Turning the Machine On/Off.....	18
Power supply precautions	18
Turning on the machine	19
Turning off the machine	19
LCD (Liquid Crystal Display) Operation.....	20
Viewing the LCD.....	20
Changing the machine settings.....	21
Checking machine operating procedures	23
Winding/Installing the Bobbin.....	25
Bobbin precautions	25
Winding the bobbin	25
Installing the bobbin	29
Upper Threading	31
About the spool of thread.....	31
Threading the upper thread	32
Threading the needle	34
Threading the needle manually (without using the needle threader)	35
Using the twin needle	36
Pulling up the bobbin thread.....	39
Replacing the Needle	40
Needle precautions	40
Needle types and their uses.....	41
Checking the needle	42
Replacing the needle.....	42
Replacing the Presser Foot	44
Presser foot precautions	44
Replacing the presser foot	44
Removing and attaching the presser foot holder	46
Sewing Cylindrical Pieces.....	47
Free-arm sewing.....	47

SEWING BASICS **49**

Sewing.....	50
General sewing procedure	50
Selecting stitching	51
Positioning the fabric	52
Starting to sew.....	53
Securing the stitching	55
Cutting the thread	56
Setting the Stitch	58
Adjusting the stitch width.....	58
Adjusting the stitch length	59
Adjusting the thread tension	59

Useful Functions	61
Automatically sewing reverse/reinforcement stitches	61
Automatically cutting the thread	62
Mirroring stitches	63
Useful Sewing Tips	64
Trial sewing	64
Changing the sewing direction	64
Sewing curves	64
Adjusting the presser foot pressure	64
Sewing thick fabrics	65
Sewing thin fabrics	66
Sewing stretch fabrics.....	66
Sewing leathers or vinyl fabrics	66
Sewing an even seam allowance.....	66
Hands-free raising and lowering of the presser foot	67

UTILITY STITCHES

69

Stitch Setting Chart	70
Utility stitches	70
Other stitches.....	74
Selecting Stitching	77
Stitch types.....	77
Selecting stitching	77
Saving stitch settings	79
Overcasting Stitches	81
Sewing overcasting stitches using overcasting foot “G”	81
Sewing overcasting stitches using zigzag foot “J”	82
Sewing overcasting stitches using the optional side cutter	83
Basic Stitching	85
Basting	85
Basic stitching.....	85
Blind Hem Stitching	87
Buttonhole Stitching/Button Sewing	89
Buttonhole sewing	90
Button sewing	94
Zipper Insertion	96
Inserting a centered zipper	96
Inserting a side zipper	98
Zipper/piping Insertion	101
Inserting a centered zipper	101
Inserting a piping	102
Sewing Stretch Fabrics and Elastic Tape	103
Stretch stitching.....	103
Elastic attaching	103
Appliqué, Patchwork and Quilt Stitching	105
Appliqué stitching	106
Patchwork (crazy quilt) stitching	107
Piecing.....	107
Quilting	109
Free-motion quilting.....	110
Satin stitching using the sewing speed controller.....	111
Reinforcement Stitching	113
Triple stretch stitching	113
Bar tack stitching.....	113
Darning.....	115
Eyelet Stitching	117
Horizontal Stitching	118
Decorative Stitching	120
Fagoting	121
Scallop stitching.....	122
Smocking	122
Shell tuck stitching	123
Joining	124
Heirloom stitching	125

Sewing the Various Built-in Decorative Patterns	128
Sewing beautiful patterns	128
Sewing patterns	128
Changing the pattern size	129
Changing the stitch density	129
Changing the length for satin stitches	130
Shifting patterns	131
Combining patterns	132
Saving patterns	135
Realigning the pattern	136
Designing a Pattern (My Custom Stitch)	139
Drawing a sketch of the pattern	139
Entering the pattern data	140
Examples of designs	142

EMBROIDERY

143

Successful Embroidering	144
What to prepare	144
Embroidery step by step	146
Attaching the Embroidery Foot	147
Attaching the embroidery foot	147
Removing the embroidery foot	149
Attaching the Embroidery Unit	150
Embroidery unit precautions	150
Attaching the embroidery unit	150
Removing the embroidery unit	152
Preparing the Fabric	153
Attaching an optional stabilizer material to the fabric	153
Setting the fabric in the embroidery frame	154
Attaching the Embroidery Frame	157
Attaching the embroidery frame	157
Removing the embroidery frame	158
Selecting Embroidery Patterns	159
Copyright information	159
Embroidery pattern types	159
LCD (liquid crystal display) operation	160
Selecting an embroidery pattern	162
Selecting characters	163
Selecting a frame pattern	164
Using an embroidery card (sold separately)	165
Embroidering	166
Sewing attractive finishes	166
Embroidering a pattern	167
Appliquéing	169
Editing Patterns	171
Adjusting the layout	171
Adjusting the thread tension	173
Adjusting the alternate bobbin case (with no color on the screw)	174
Resewing	175
Thread runs out partway through a design	175
Stopping while embroidering	176
Using the Memory Function	178
Embroidery data precautions	178
Saving patterns	180
Transferring embroidery patterns from the computer to machine	181

Care and Maintenance	184
Cleaning the machine surface	184
Cleaning the race	184
Troubleshooting	186
Error messages	191
Adjusting the LCD	194
Operation beep	194
Canceling the operation beep	195
Upgrading Your Machine's Software Using USB Media	196
Index	197

Introduction

Thank you for purchasing this sewing machine. Before using this sewing machine, carefully read the "IMPORTANT SAFETY INSTRUCTIONS" (page 1), and then study this manual for the correct operation of the various functions. In addition, after you have finished reading this manual, store it where it can quickly be accessed for future reference.

Sewing Machine Features

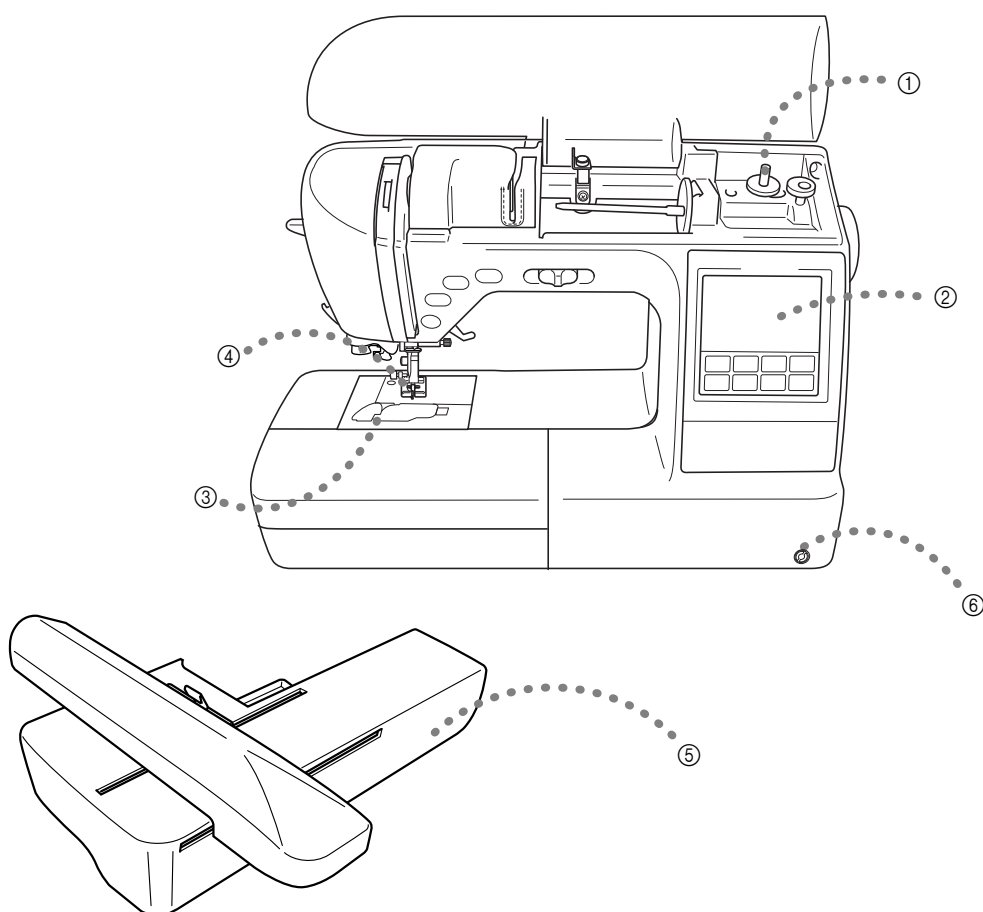

- ① **Simple bobbin-winding**
The bobbin can quickly and easily be wound with thread (page 25).
- ② **Built-in stitches**
You can select from the built-in stitches available, including utility stitches and decorative stitches (page 70).
- ③ **Quick-set bobbin**
You can start sewing without pulling up the bobbin thread (page 29).
- ④ **Automatic thread cutting**
The thread can be cut automatically after sewing (page 62).
- ⑤ **Embroidery**
You can embroider built-in embroidery patterns, characters, framed decorations, and designs from optional embroidery cards (page 143).
- ⑥ **Knee lifter**
Use the knee lifter to raise and lower the presser foot with your knee, leaving both hands free to handle the fabric (page 67).

Accessories

Included accessories

After opening the box, check that the following accessories are included. If any item is missing or damaged, contact your dealer.

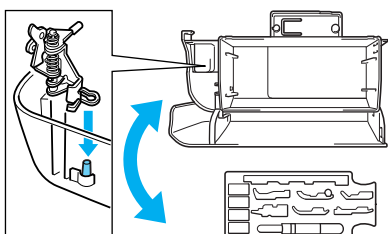

Note

(For U.S.A. only)

- Foot controller: Model T
This foot controller can be used on this machine model NV1250D.
- The screw for the presser foot holder is available through your authorized dealer. (Part code: 132730-122)
- The organized accessory tray is available through your authorized dealer. (Part code: XC4489-051)

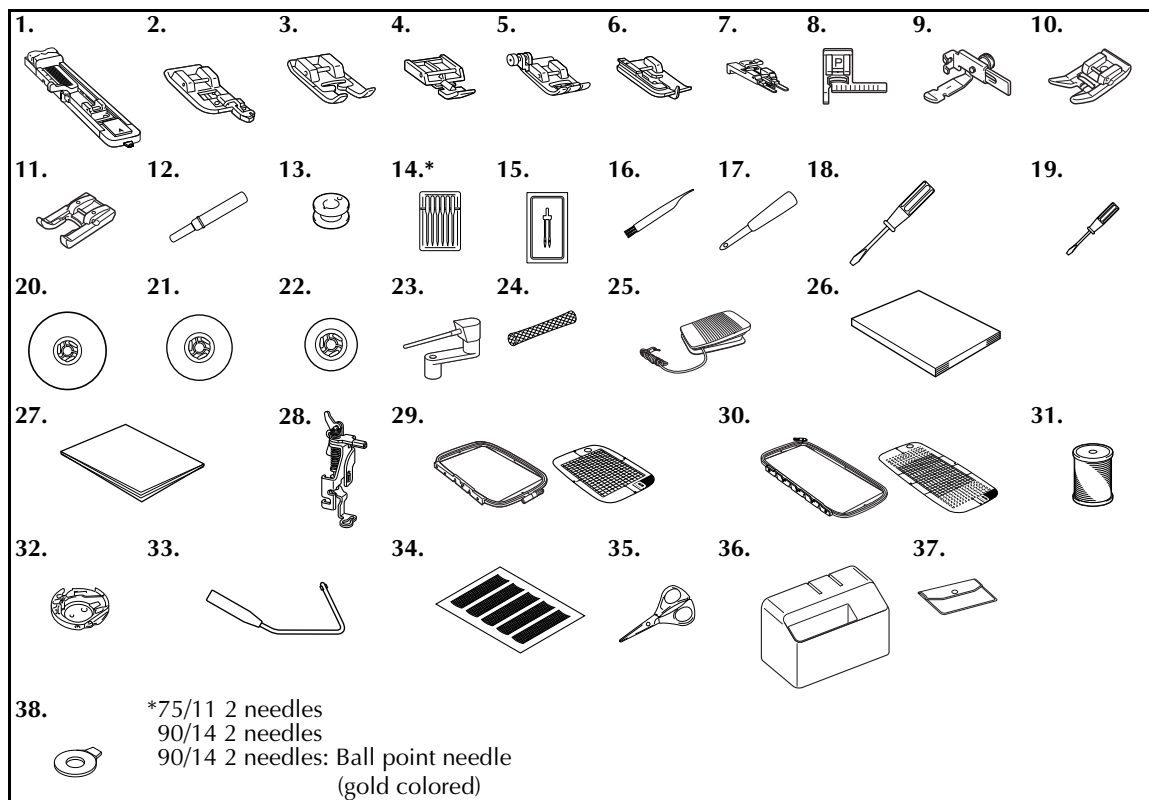

No.	Part Name	Part Code	
		U.S.A. / Canada	Others
1	Buttonhole foot "A"	XC2691-023	
2	Overcasting foot "G"	XC3098-031	
3	Monogramming foot "N"	XD0810-031	
4	Zipper foot "I"	X59370-021	
5	Zigzag foot "J" (on machine)	XC3021-031	
6	Blind stitch foot "R"	XE2650-001	
7	Button fitting foot "M"	XE2643-001	
8	Stitch guide foot "P"	SA160	F035N
9	Adjustable zipper/piping foot	SA161	F036N
10	Non stick foot	SA114	F007N
11	Open toe foot	SA186	F060
12	Seam ripper	X54243-051	
13	Bobbin (4)	SA156	SFB
14	Needle set	X58358-021	
15	Twin needle	X59296-121	
16	Cleaning brush	X59476-021	
17	Eyelet punch	135793-001	
18	Screwdriver (large)	XC8349-021	
19	Screwdriver (small)	X55468-021	
20	Spool cap (large)	130012-024	
21	Spool cap (medium) (2)	XE1372-001	
22	Spool cap (small)	130013-124	

No.	Part Name	Part Code	
		U.S.A. / Canada	Others
23	Extra spool pin	XC4654-051	
24	Spool net	XA5523-020	
25	Foot controller	XD0501-021(EU area) XC8816-021(other areas)	
26	Operation manual	XE6389-001	
27	Quick reference guide	XD1237-121	
28	Embroidery foot "Q"	XD0474-151	
29	Embroidery set (large) H 18 cm × W 13 cm (H 7 inches × W 5 inches)	SA444/ EF84	EF84
30	Embroidery set (extra large (multi-position)) H 30 cm × W 13 cm (H 12 inches × W 5 inches)	SA445/ EF85	EF85
31	Embroidery bobbin thread (white)	SA-EBT	EBT-CEN
32	Alternate bobbin case (no color on the screw)	XC8167-451	
33	Knee lifter	XA6941-052	
34	Grid sheet set	SA527	GS4
35	Scissors	XC1807-121	
36	Hard case	XC9701-052	
37	Accessory bag	XC4487-021	
38	Disc-shaped screwdriver	XC1074-051	

Optional accessories

The following are available as optional accessories.

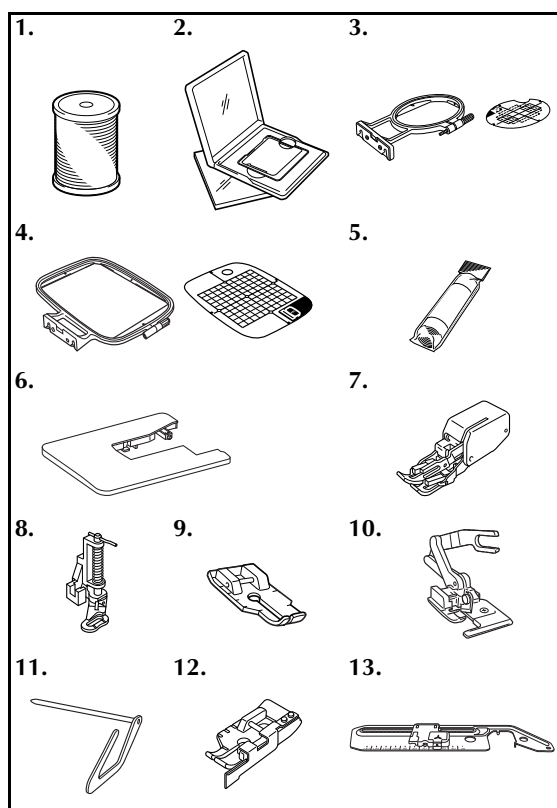

No.	Part Name	Part Code	
		U.S.A. / Canada	Others
1	Embroidery bobbin thread (white)	SA-EBT	EBT-CEN
	Embroidery bobbin thread (black)	SAEBT999	EBT-CEBN
2	Embroidery card		
3	Embroidery set (small) H 2 cm × W 6 cm (H 1 inch × W 2-1/2 inches)	SA442/ EF82	EF82
4	Embroidery set (medium) H 10 cm × W 10 cm (H 4 inches × W 4 inches)	SA443/ EF83	EF83
5	Water soluble stabilizer	SA520	BM5
	Stabilizer material for embroidery	SA519	BM3
6	Wide table	SA551	WT5
7	Walking foot	SA140	F033N
8	Quilting foot	SA129	F005N
9	1/4 inch quilting foot	SA125	F001N
10	Side cutter "S"	SA177	F054
11	Quilting guide	SA132	F016N
12	1/4 inch quilting foot with guide	SA185	F057
13	Circular attachment	SACIRC1	CIRC1



Memo

- To obtain optional accessories or parts, contact your sales representative or the nearest authorized service center.
- All specifications are correct at the time of printing. The part codes are subject to change without notice.
- Visit your nearest authorized retailer for a complete listing of optional accessories available for your machine.

Names of Machine Parts and Their Functions

The names of the various parts of the sewing machine and their functions are described below. Before using the sewing machine, carefully read these descriptions to learn the names of the machine parts.

Front view

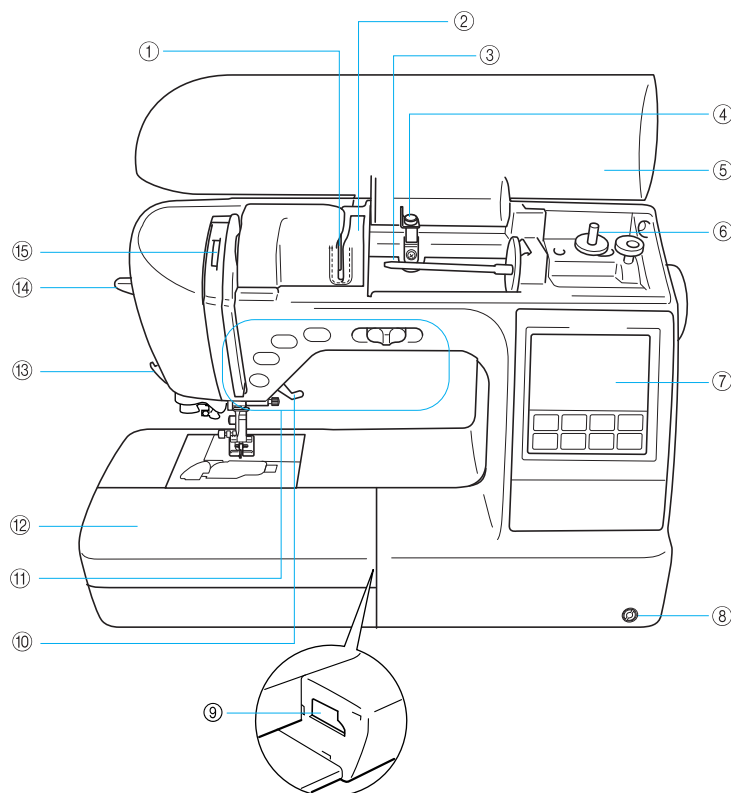

- ① **Thread guide plate**
Pass the thread under the thread guide plate.
- ② **Thread guide cover**
Pass the thread behind the thread guide cover when threading the upper thread.
- ③ **Spool pin**
Place a spool of thread on the spool pin.
- ④ **Bobbin winding thread guide and pretension disk**
Pass the thread under this thread guide and around the pretension disk when winding the bobbin thread.
- ⑤ **Top cover**
Open the top cover to place the spool of thread on the spool pin.
- ⑥ **Bobbin winder**
Use the bobbin winder when winding the bobbin.
- ⑦ **Operation panel**
From the operation panel, stitch settings can be viewed and edited, and operations for using the machine can be displayed (page 16).
- ⑧ **Knee lifter mounting slot**
Insert the knee lifter into the knee lifter mounting slot.
- ⑨ **Embroidery unit connector slot**
Plug in the connector for the embroidery unit.
- ⑩ **Presser foot lever**
Raise and lower the presser foot lever to raise and lower the presser foot.
- ⑪ **Operation buttons and sewing speed controller**
Use these buttons and the slide to operate the sewing machine (page 15).
- ⑫ **Flat bed attachment**
Insert the accessories tray into the accessory compartment of the flat bed attachment. Remove the flat bed attachment when sewing cylindrical pieces such as sleeve cuffs.
- ⑬ **Thread cutter**
Pass the threads through the thread cutter to cut them.
- ⑭ **Needle threader lever**
Use the needle threader lever to thread the needle.
- ⑮ **Thread take-up lever check window**
Look through the window to check the position of the take-up lever.

Needle and presser foot section

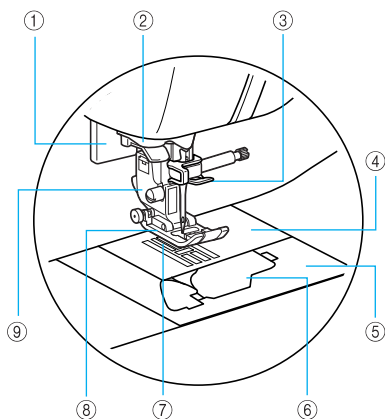

- ① **Buttonhole lever**
The buttonhole lever is used with the one-step buttonhole foot to create buttonholes.
- ② **Thread guide disk**
Pass the thread through the thread guide disk when using the needle threader to thread the needle.
- ③ **Needle bar thread guide**
Pass the upper thread through the needle bar thread guide.
- ④ **Needle plate**
The needle plate is marked with guides to help sew straight seams.
- ⑤ **Needle plate cover**
Remove the needle plate cover to clean the bobbin case and race.
- ⑥ **Bobbin cover**
Open the bobbin cover to set the bobbin.
- ⑦ **Feed dogs**
The feed dogs feed the fabric in the sewing direction.
- ⑧ **Presser foot**
The presser foot applies pressure consistently on the fabric as sewing takes place. Attach the appropriate presser foot for the selected stitch.
- ⑨ **Presser foot holder**
The presser foot is attached onto the presser foot holder.

Right-side/rear view

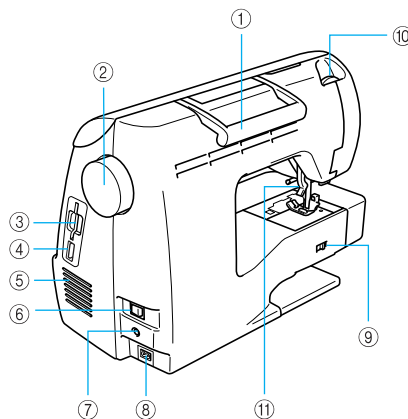

- ① **Handle**
Carry the sewing machine by its handle when transporting the machine.
- ② **Handwheel**
Turn the handwheel toward you to raise and lower the needle. The handwheel should be turned towards you (counterclockwise).
- ③ **Embroidery card slot**
Insert the embroidery card.
- ④ **USB port (for a USB flash drive (USB flash memory))**
In order to import patterns from a USB flash drive (USB flash memory), plug the USB media directly into the USB port.
- ⑤ **Air vent**
The air vent allows the air surrounding the motor to circulate. Do not cover the air vent while the sewing machine is being used.
- ⑥ **Main power switch**
Use the main power switch to turn the sewing machine ON and OFF.
- ⑦ **Foot controller jack**
Insert the plug on the end of the foot controller cable into the foot controller jack.
- ⑧ **Power supply jack**
Insert the plug on the power cord into the power supply jack.
- ⑨ **Feed dog position switch**
Use the feed dog position switch to lower the feed dogs.
- ⑩ **Presser foot pressure dial**
Use the presser foot pressure dial to adjust the amount of pressure that the presser foot applies.
- ⑪ **Presser foot lever**
Raise and lower the presser foot lever to raise and lower the presser foot.

Memo

- Refer to pages 13 through 16 while you are learning to use your machine.

Operation buttons

The operation buttons help you to easily perform various basic sewing machine operations.

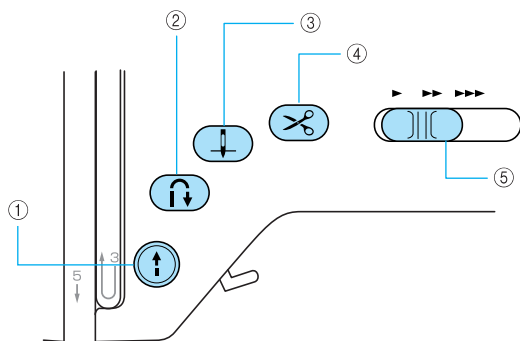

① “Start/Stop” button

Press the “Start/Stop” button to start or stop sewing. The machine sews at a slow speed at the beginning of sewing while the button is pressed. When sewing is stopped, the needle is lowered in the fabric. For details, refer to “Starting to sew” (page 53). The button changes color according to the machine’s operation mode.

- Green: The machine is ready to sew or is sewing.
- Red: The machine can not sew.
- Orange: The machine is winding the bobbin thread, or the bobbin winder shaft is moved to the right side.

② “Reverse/Reinforcement Stitch” button

Press the “Reverse/Reinforcement Stitch” button to sew reverse stitches or reinforcement stitches. Reverse stitches are sewn by keeping the button pressed down to sew in the opposite direction. Reinforcement stitches are sewn by sewing 3 to 5 stitches on top of each other. For details, refer to “Securing the stitching” (page 55).

③ “Needle Position” button

Press the “Needle Position” button to raise or lower the needle. Pressing the button twice sews one stitch.

④ “Thread Cutter” button

Press the “Thread Cutter” button after sewing is stopped to cut both the upper and the bobbin threads. For details, refer to “Cutting the thread” (page 56).

⑤ Sewing speed controller

Slide the sewing speed controller to adjust the sewing speed.

Note

- Do not press  (“Thread Cutter” button) if there is no fabric under the presser foot or while the machine is sewing, otherwise damage to the machine may occur.
- When cutting thread thicker than #30, nylon thread or other special threads, use the thread cutter on the side of the machine. For details, refer to “Using the thread cutter” (page 57).







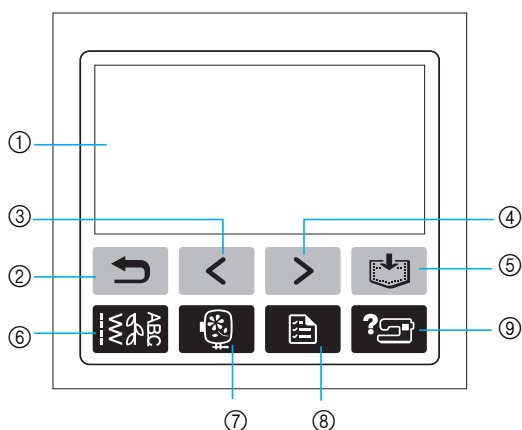

CAUTION

- Do not press  (“Thread Cutter” button) after the threads have already been cut, otherwise the needle may break, the threads may become tangled or damage to the machine may occur.

Operation panel

The front operation panel has an LCD (liquid crystal display) and operation keys.



- ① **LCD (liquid crystal display) (touch panel)**
Selected pattern settings and messages are displayed. Touch the keys displayed on the LCD to perform operations. For details, refer to “LCD (Liquid Crystal Display) Operation” (page 20).
- ② **Back key** 
Press to return to the previous screen.
- ③ **Previous page key** 
Displays the previous screen when there are items that are not displayed on the LCD.
- ④ **Next page key** 
Displays the next screen when there are items that are not displayed on the LCD.
- ⑤ **Memory key** 
Press to enter character embroidery, combined stitch patterns, My Custom Stitch patterns, etc into the sewing machine memory.
- ⑥ **Utility stitch key** 
Press this key to select a utility stitch or decorative stitch or to design a stitch pattern using the My Custom Stitch function.
- ⑦ **Embroidery key** 
Press this key to sew embroidery.
- ⑧ **Settings key** 
Press to set the needle stop position, the buzzer sound, and more.
- ⑨ **Sewing machine help key** 
Press to get help on using the sewing machine. Displays simple explanations of setting upper thread / bobbin winding / setting bobbin thread / needle replacement / embroidery unit attachment / embroidery frame attachment / embroidery foot attachment / presser foot replacement.

**1**

GETTING READY

The various preparations required before starting to sew are described in this chapter.

Turning the Machine On/Off	18
Power supply precautions	18
Turning on the machine	19
Turning off the machine	19
LCD (Liquid Crystal Display) Operation.....	20
Viewing the LCD	20
Changing the machine settings.....	21
Checking machine operating procedures	23
Winding/Installing the Bobbin.....	25
Bobbin precautions	25
Winding the bobbin	25
Installing the bobbin	29
Upper Threading	31
About the spool of thread	31
Threading the upper thread.....	32
Threading the needle.....	34
Threading the needle manually (without using the needle threader).....	35
Using the twin needle	36
Pulling up the bobbin thread.....	39
Replacing the Needle	40
Needle precautions	40
Needle types and their uses.....	41
Checking the needle.....	42
Replacing the needle	42
Replacing the Presser Foot	44
Presser foot precautions	44
Replacing the presser foot.....	44
Removing and attaching the presser foot holder	46
Sewing Cylindrical Pieces.....	47
Free-arm sewing.....	47

Turning the Machine On/Off

This section explains how to turn the sewing machine on and off.

Power supply precautions

Be sure to observe the following precautions concerning the power supply.

WARNING

- Use only regular household electricity for the power source. Using other power sources may result in fire, electric shock, or damage to the machine.
- Make sure that the plugs on the power cord are firmly inserted into the electrical outlet and the power supply jack on the machine.
- Do not insert the plug on the power cord into an electrical outlet that is in poor condition.
- Turn off the main power and remove the plug in the following circumstances:
 - When you are away from the machine
 - After using the machine
 - When the power fails during use
 - When the machine does not operate correctly due to a bad connection or a disconnection
 - During electrical storms

CAUTION

- Use only the power cord included with this machine.
- Do not use extension cords or multi-plug adapters with many other appliances plugged in to them. Fire or electric shock may result.
- Do not touch the plug with wet hands. Electric shock may result.
- When unplugging the machine, always turn off the main power first. Always grasp the plug to remove it from the outlet. Pulling on the cord may damage the cord, or lead to fire or electric shock.
- Do not allow the power cord to be cut, damaged, modified, forcefully bent, pulled, twisted, or bundled. Do not place heavy objects on the cord. Do not subject the cord to heat. These things may damage the cord and cause fire or electric shock. If the cord or plug is damaged, take the machine to your authorized dealer for repairs before continuing use.
- Unplug the power cord if the machine is not to be used for a long period of time. Otherwise a fire may result.

Turning on the machine

Prepare the included power cord.

- 1 Make sure that the sewing machine is turned off (the main power switch is set to “○”), and then plug the power cord into the power supply jack on the right side of the machine.
- 2 Insert the plug of the power cord into a household electrical outlet.

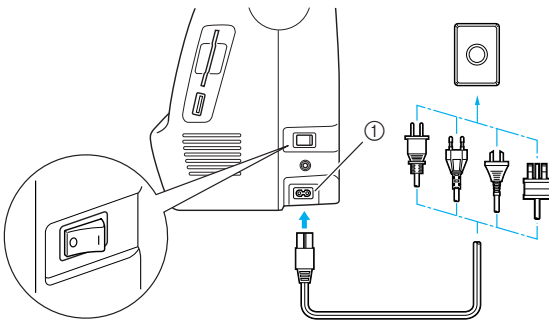

① Power supply jack

- 3 Press the right side of the main power switch on the right side of the machine to turn the machine on (set it to “I”).

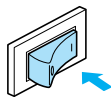

- ▶ The light, LCD and  (“Start/Stop” button) light up when the machine is turned on.

Turning off the machine

When you are finished using the sewing machine, turn it off. In addition, before transporting the sewing machine to another location, be sure to turn it off.

- 1 Make sure that the machine is not sewing.
- 2 Press the left side of the main power switch on the right side of the machine to turn the machine off (set it to “○”).

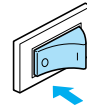

- ▶ The sewing lamps and the LCD go off when the machine is turned off.

- 3 Unplug the power cord from the electrical outlet.

Grasp the plug when unplugging the power cord.

- 4 Unplug the power cord from the power supply jack.

Note

- If a power outage occurs while the sewing machine is being operated, turn off the sewing machine and unplug the power cord. When restarting the sewing machine, follow the necessary procedure to correctly operate the machine.

(For U.S.A. only)

- This appliance has a polarized plug (one blade wider than the other). To reduce the risk of electrical shock, this plug is intended to fit in a polarized outlet only one way. If the plug does not fit fully in the outlet, reverse the plug. If it still does not fit, contact a qualified electrician to install the proper outlet. Do not modify the plug in any way.

LCD (Liquid Crystal Display) Operation

Selected stitch, pattern settings and messages are displayed on the LCD (liquid crystal display) on the front of the sewing machine.

Viewing the LCD

When the power is turned on, the LCD comes on, and the following screen is displayed.

The screen is changed using the keys below the screen, and operations performed by directly touching the icons on the LCD screen.

Utility stitch selection screen

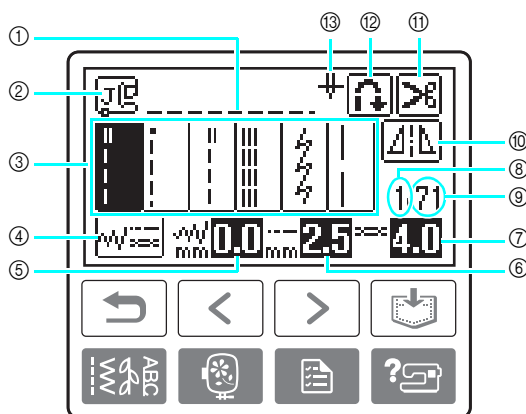

- ① Selected stitch
- ② Presser foot to be used
- ③ Stitches
- ④ Stitch settings and twin needle sewing
- ⑤ Stitch width (mm)
- ⑥ Stitch length (mm)
- ⑦ Thread tension
- ⑧ Number of the selected stitch
- ⑨ Number of stitches contained in the selected stitch type
- ⑩ Horizontal mirror image
- ⑪ Automatic thread cutting
- ⑫ Automatic reverse/reinforcement
- ⑬ Single/twin needle sewing and needle stop position

Stitch type selection screen

Press  (Utility stitch key) to display the screen for selecting the stitch type. The details are explained in "Selecting stitching" (page 51).

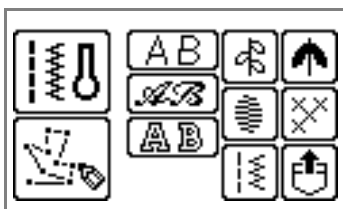

Memo

- A different screen is displayed when the embroidery unit is attached.
- Refer to "Error messages" (page 191) for messages displayed on the LCD.
- Depending on the model of sewing machine, an animation may be displayed when the power is turned on. When an animation is displayed, the screen above will be displayed if you touch the LCD with your finger.

Changing the machine settings

Various sewing machine operations and sewing settings can be changed. The stitch or machine attributes that can be set are listed below.

Attribute	Icon	Details	Settings
Needle position		Specifies where the needle is positioned when the sewing machine is stopped.	Down Up
Stitch width control		Allows the stitch width to be adjusted with the sewing speed controller.	
Vertical pattern adjustment		Adjusts the up and down position of the pattern (page 136).	-9 to +9
Horizontal pattern adjustment		Adjusts the left and right position of the pattern (page 136).	-9 to +9
Thread color display		Changes the thread color display on the embroidery screen.	Thread color/Time to embroider/ Needle count/Thread number (#123)
		(When "Thread No. #123" is selected)	Embroidery/Country/Madeira poly/ Madeira rayon/Sulky/Robison anton
Display unit		Selects the measurement units that are displayed (only for embroidering).	mm/INCH
Embroidery tension		Adjusts the thread tension for embroidering (only for embroidering).	-8 to +8
Max embroidery speed		Specifies the maximum embroidering speed.	
Buzzer		Specifies whether or not a beep is sounded with each operation (page 195).	
Opening screen		Sets whether or not to display the opening screen when the power is turned on. (There are models where this cannot be changed.)	
Initial needle position		Select the straight stitch that is automatically selected when the machine is turned on.	
Language		Allows the language used in the screens to be changed.	English/French/Spanish/Portuguese/ Korean/others Memo Depending on the model, the following languages may also be available. German/Italian/Dutch/Japanese/ Danish/Norwegian/Finnish/ Swedish/Russian/Thai
LCD brightness		Adjusts the brightness of the LCD.	Lighter Darker
Stitch counter		Display the service count and the total number of embroidery stitches. The service count is a reminder to take your machine in for regular servicing. (Contact your authorized dealer for details.)	_____
Product number	NO.:	The "NO." is the number for the sewing and embroidery machine.	_____
Program version	VERSION:	Display the program version.	_____

1 Turn on the sewing machine.

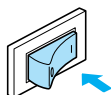

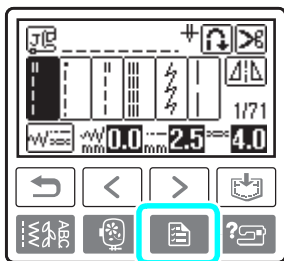

▶ The LCD comes on.

2 Press  (Settings key) on the operation panel.



▶ The settings screen appears.

3 Press the item to be set.

Switch screens using  (Previous page key) and  (Next page key).

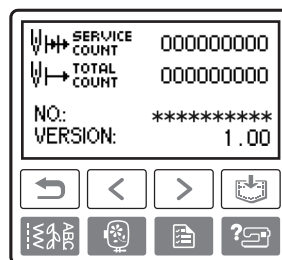

• The items shown in reverse highlighting are the settings at the time of purchase.

□ **Example:** Changing the needle stop position

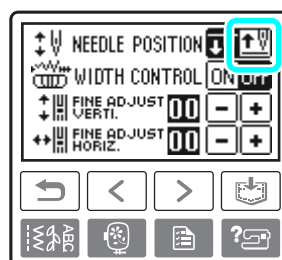

- 4 When settings are complete, press  (Back key).

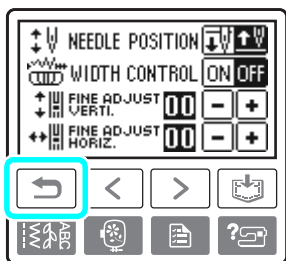

▶ The initial screen appears again.



Note

- Settings that are changed are not lost when the power is turned off.

Checking machine operating procedures

Displays simple explanations of setting upper thread / bobbin winding / setting bobbin thread / needle replacement / embroidery unit attachment / embroidery frame attachment / embroidery foot attachment / presser foot replacement on the LCD.

- 1 Turn on the sewing machine.

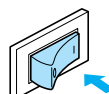

▶ The LCD comes on.

- 2 Press  (Sewing machine help key) on the operation panel.

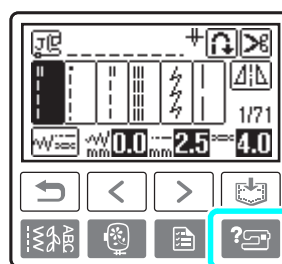

▶ The sewing machine help screen appears.

- 3 Press the item to be displayed.

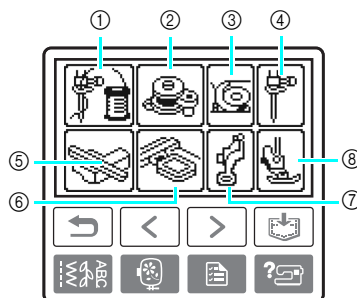

- ① Upper threading
- ② Bobbin winding
- ③ Bobbin installation
- ④ Needle replacement
- ⑤ Embroidery unit attachment
- ⑥ Embroidery frame attachment
- ⑦ Embroidery foot attachment
- ⑧ Presser foot replacement

▶ The first screen describing the procedure for the selected topic appears.

- Pressing  (Back key), returns you to the item selection screen.

- 4 Press  (Next page key) to switch to the next page.

If you press , you return to the previous page.

- **Example:** Upper threading

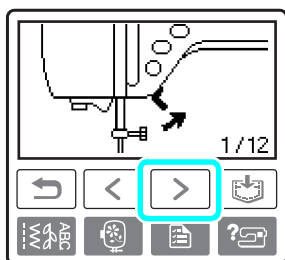

⋮

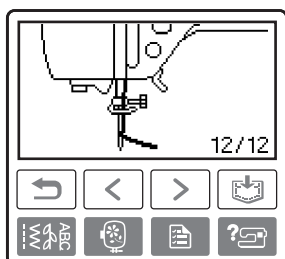

- 5 After you finish looking, press  (Back key) two times.

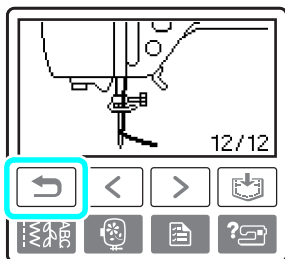

- ▶ The initial stitch screen appears again.

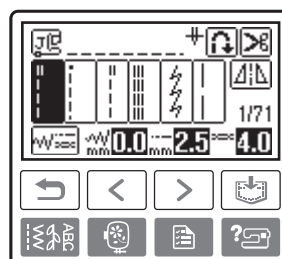

Note

- For details on each topic, refer to the corresponding page in this Operation Manual.

Winding/Installing the Bobbin

This section describes how to wind the thread onto the bobbin, and then insert the bobbin thread.

Bobbin precautions

Be sure to observe the following precautions concerning the bobbin.

! CAUTION

- Only use the Bobbin (part code: SA156, SFB) designed specifically for this sewing machine. Use of any other bobbin may result in injuries or damage to the machine.
- The included bobbin was designed specifically for this sewing machine. If bobbins from other models are used, the machine will not operate correctly. Use only the included bobbin or bobbins of the same type (part code: SA156, SFB).

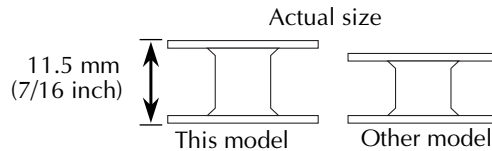

Winding the bobbin

Wind the thread around the bobbin to prepare the bobbin thread.

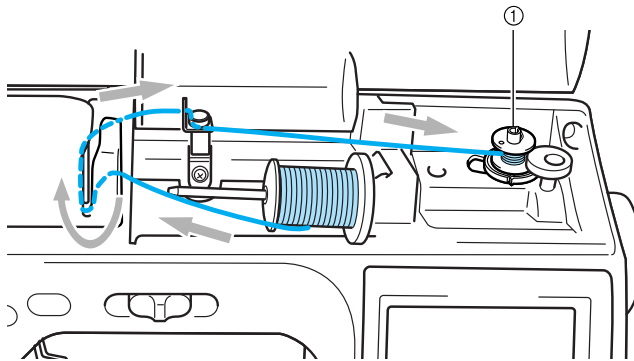

① Bobbin winder



Memo

- The order that the machine should be threaded for winding the bobbin is indicated by a broken line on the sewing machine. Be sure to thread the machine as indicated.

- 1 Turn on the sewing machine.

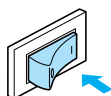

- 2 Open the top cover.

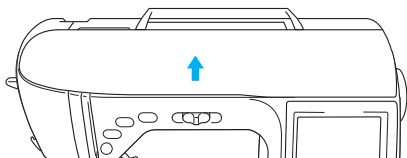

- 3 Place the bobbin on the bobbin winder shaft so that the spring on the shaft fits into the notch in the bobbin.

Press down on the bobbin until it snaps into place.

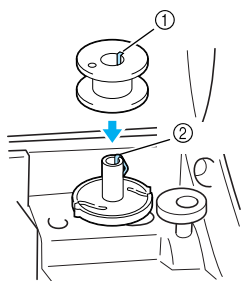

- ① Notch
② Bobbin winder shaft spring

- 4 Slide the bobbin winder in the direction of the arrow until it snaps into place.

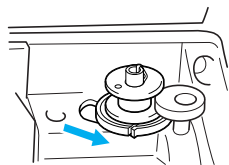

- ⓘ (“Start/Stop” button) lights up in orange.

- 5 Remove the spool cap that is inserted onto the spool pin.

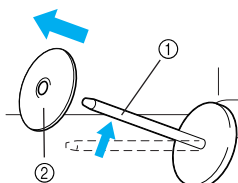

- ① Spool pin
② Spool cap

- 6 Place the spool of thread for the bobbin onto the spool pin.

Slide the spool onto the pin so that the spool is horizontal and the thread unwinds to the front at the bottom.

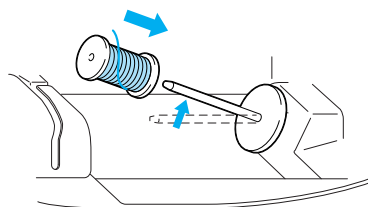

- If the spool is not positioned so that the thread unwinds correctly, the thread may become tangled around the spool pin.

- 7 Slide the spool cap onto the spool pin.

Slide the spool cap as far as possible to the right, as shown, with the rounded side on the left.

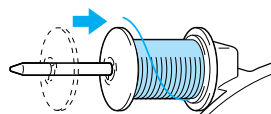

! CAUTION

- If the spool or the spool cap is not positioned correctly, the thread may become tangled around the spool pin and the needle may break.
- Three spool cap sizes are available (large, medium and small), allowing you to choose a spool cap that best fits the size of spool being used. If the spool cap is too small for the spool being used, the thread may catch on the slit in the spool and the needle may break.

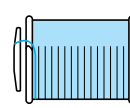
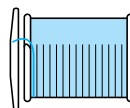



Memo

- When sewing with fine, cross-wound thread, use the small spool cap, and leave a small space between the cap and the spool.

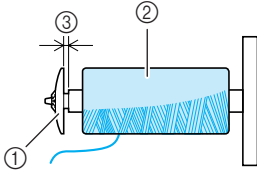

- ① Spool cap (small)
- ② Spool (cross-wound thread)
- ③ Space

- When using thread that winds off quickly, such as transparent nylon thread or metallic thread, place the spool net over the spool before placing the spool of thread onto the spool pin.

If the spool net is too long, fold it to fit the size of the spool.

- When the spool net is used, the tension of the upper thread will slightly increase. Be sure to check the thread tension. For details, refer to "Adjusting the thread tension" (page 59).

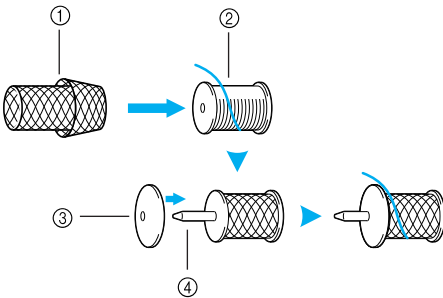

- ① Spool net
- ② Spool
- ③ Spool cap
- ④ Spool pin

8

While holding the thread near the spool with your right hand, as shown, pull the thread with your left hand, and then pass the thread behind the thread guide cover and to the front.

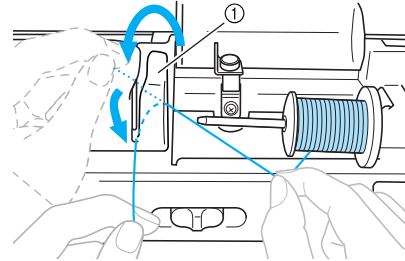

- ① Thread guide cover

9

Pass the thread under the thread guide plate, and then pull it to the right.

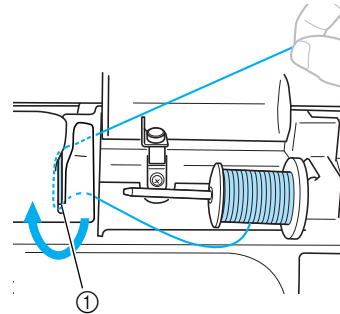

- ① Thread guide plate

10

Pass the thread under the hook on the thread guide, and then wind it counterclockwise under the pretension disk.

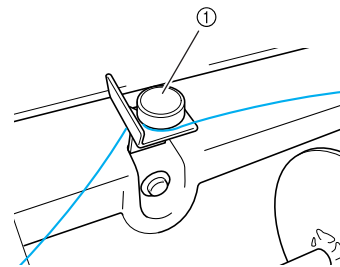
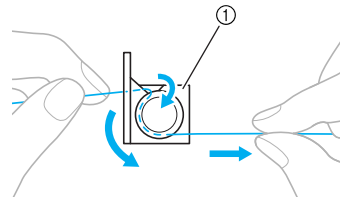

- ① Thread guide and pretension disk



Note

- Make sure that the thread passes under the pretension disk.

- 11** While holding the thread with your left hand, wind the thread that was pulled out clockwise around the bobbin five or six times with your right hand.

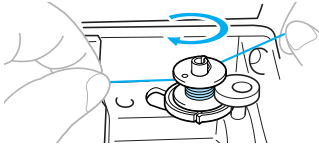
**Note**

- Make sure that the thread between the spool and the bobbin is pulled tight.
- Be sure to wind the thread clockwise around the bobbin, otherwise the thread will become wrapped around the bobbin winder shaft.

- 12** Pass the end of the thread through the guide slit in the bobbin winder seat, and then pull the thread to the right to cut it.

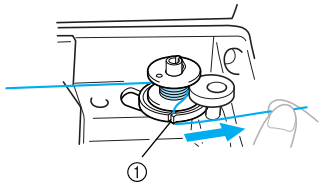

- ① Guide slit in bobbin winder seat (with built-in cutter)

▶ The thread is cut to a suitable length.

**CAUTION**

- Be sure to cut the thread as described. If the bobbin is wound without cutting the thread using the cutter built into the slit in the bobbin winder seat, the thread may become tangled in the bobbin and the needle may bend or break when the bobbin thread starts to run out.

- 13** Slide the sewing speed controller to the right to increase the bobbin winding speed and slide to left to decrease.

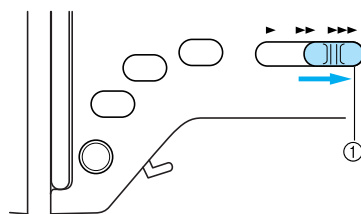

- ① Speed controller

- 14** Press ("Start/Stop" button) once to start winding the bobbin.

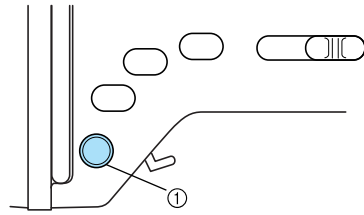

- ① "Start/Stop" button

- When the bobbin winding becomes slow, press ("Start/Stop" button) once to stop the machine.

**CAUTION**

- When the bobbin winding becomes slow, stop the machine, otherwise the sewing machine may be damaged.

- 15** Use scissors to cut the end of the thread wound around the bobbin.

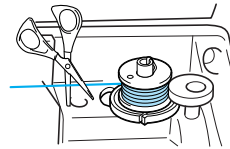

- 16** Slide the bobbin winder shaft to the left, and then remove the bobbin from the shaft.

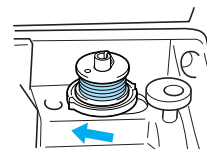

- 17** Remove the spool for the bobbin thread from the spool pin, and then close the top cover.

**Memo**

- When the sewing machine is started or the handwheel is turned after winding the bobbin, the machine will make a clicking sound; this is not a malfunction.

Installing the bobbin

Install the bobbin wound with thread.

CAUTION

- Use a bobbin that has been correctly wound with thread, otherwise the needle may break or the thread tension will be incorrect.

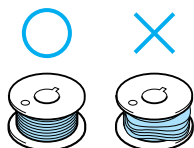

- The bobbin was designed specifically for this sewing machine. If bobbins from other models are used, the machine will not operate correctly. Use only the included bobbin or bobbins of the same type (part code: SA156, SFB).

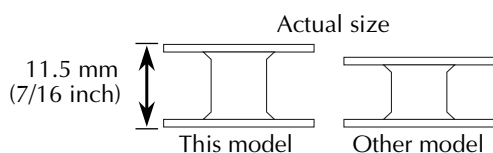

- 1 Slide the bobbin cover latch to the right.

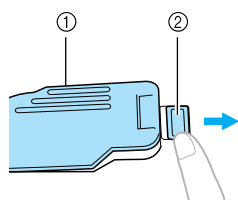

- 1 Bobbin cover
- 2 Latch

▶ The bobbin cover opens.

- 2 Remove the bobbin cover.

- 3 Hold the bobbin with your right hand and hold the end of the thread with your left.

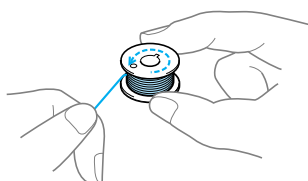

- Be careful not to drop the bobbin.

- 4 Insert the bobbin into the bobbin case so that the thread unrolls to the left.

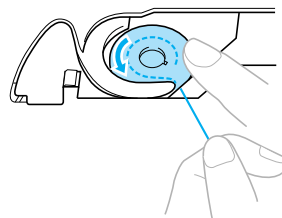

- Be sure to insert the bobbin correctly.

CAUTION

- Be sure to install the bobbin so that the thread unwinds in the correct direction, otherwise the thread may break or the thread tension will be incorrect.

Memo

- The order that the bobbin thread should be passed through the bobbin case is indicated by marks around the bobbin case. Be sure to thread the machine as indicated.

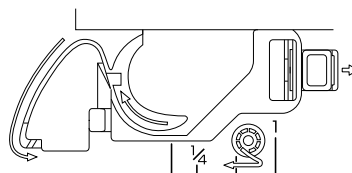

- 5 Lightly hold down the bobbin with your right hand, and then guide the thread as shown with your left hand.

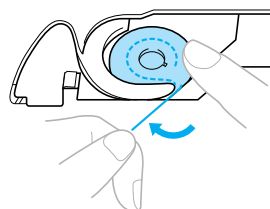

CAUTION

- When installing the bobbin, be sure to hold it down with your finger. If the bobbin is not correctly installed, the thread tension will be incorrect.

- 6** Pass the thread through the slot as shown, and then pull the thread out toward the front.

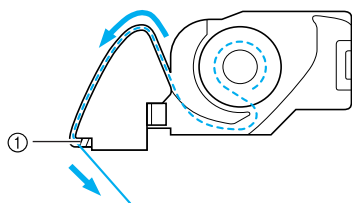

① Cutter

▶ The cutter cuts the thread.



Note

- Make sure that the thread is correctly inserted through the tension-adjusting spring of the bobbin case. If it is not inserted correctly, reinsert the thread.

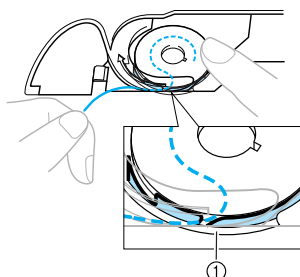

① Tension-adjusting spring

- 7** Reattach the bobbin cover.
Insert the tab in the lower-left corner of the bobbin cover, and then lightly press down on the right side.

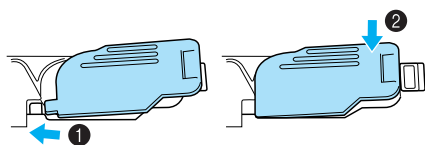

▶ The bobbin threading is finished.

Next, thread the upper thread. Continue with the procedure in “Upper Threading” (page 31).



Memo

- You can begin sewing without pulling up the bobbin thread. If you wish to pull up the bobbin thread before starting to sew, pull up the thread according to the procedure in “Pulling up the bobbin thread” (page 39).

Upper Threading

This section describes how to position the spool for the upper thread, and then thread the needle.

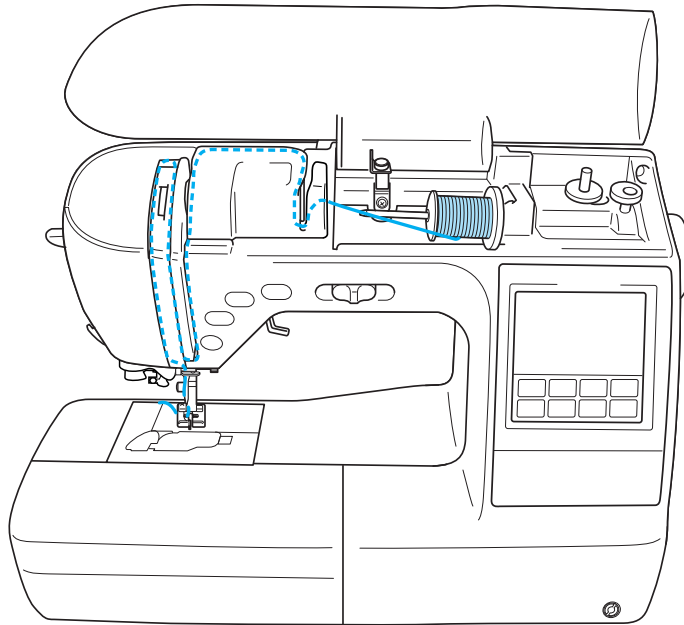

CAUTION

- When threading the upper thread, carefully follow the instructions. If the upper threading is not correct, the thread may become tangled and the needle may bend or break.



Memo

- The order that the machine should be threaded is indicated by a solid line on the sewing machine. Be sure to thread the machine as indicated.

About the spool of thread

Information about the spools of thread is described below.

CAUTION

- Three spool cap sizes are available (large, medium and small), allowing you to choose a spool cap that best fits the size of spool being used. If the spool cap is too small for the spool being used, the thread may catch on the slit in the spool and the needle may break.

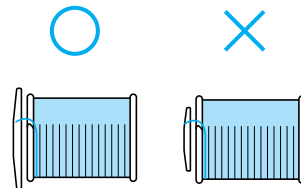

Threading the upper thread

Set the spool of thread on the spool pin, and then thread the machine.

- 1 Turn on the sewing machine.

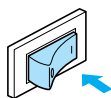

- 2 Raise the presser foot lever to raise the presser foot.

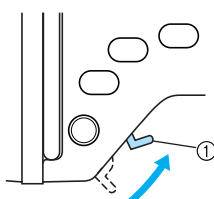

- ① Presser foot lever



Note

- If the presser foot is not raised, the sewing machine cannot be threaded.

- 3 Press  ("Needle Position" button) once or twice to raise the needle.

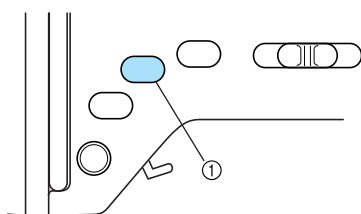

- ① "Needle Position" button

- ▶ The needle is correctly raised when the mark on the handwheel is at the top, as shown below. Check the handwheel and, if this mark is not at this position, press  ("Needle Position" button) until it is.

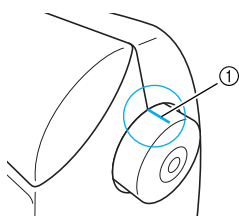

- ① Mark on handwheel

- 4 Open the top cover.

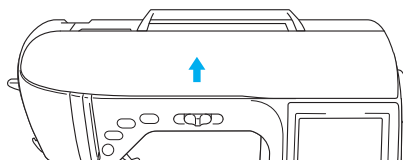

- 5 Remove the spool cap that is inserted onto the spool pin.

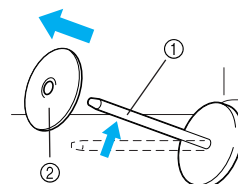

- ① Spool pin
② Spool cap

- 6 Place the spool of thread onto the spool pin. Slide the spool onto the pin so that the spool is horizontal and the thread unwinds to the front at the bottom.

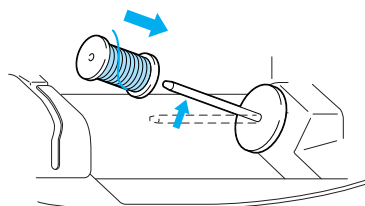

CAUTION

- If the spool or the spool cap is not positioned correctly, the thread may become tangled around the spool pin and the needle may break.

- 7 Slide the spool cap onto the spool pin. Slide the spool cap as far as possible to the right, as shown, with the rounded side on the left.

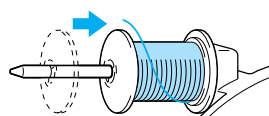

- 8** While holding the thread lightly with your right hand, pull the thread with your left hand, and then pass the thread behind the thread guide cover and to the front.

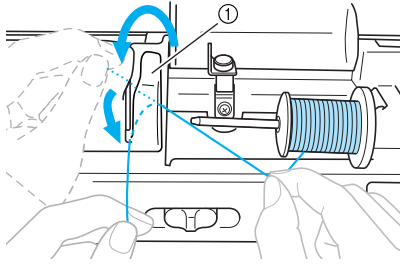

① Thread guide cover

- 9** Pass the thread under the thread guide plate, and then pull it up.

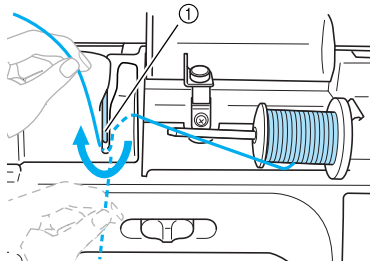

① Thread guide plate

- 10** While using your right hand to lightly hold the thread passed under the thread guide plate, pass the thread through the thread path in the order shown below.

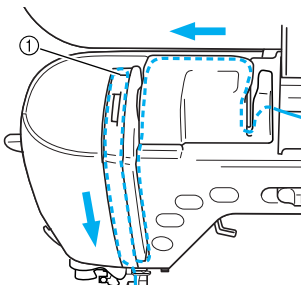

① Shutter

Note

- If the presser foot has been lowered and the shutter is closed, the machine cannot be threaded. Be sure to raise the presser foot and open the shutter before threading the machine. In addition, before removing the upper thread, be sure to raise the presser foot and open the shutter.
- This machine is equipped with a window that allows you to check the position of the take-up lever. Look through this window and check that the thread is correctly fed through the take-up lever.

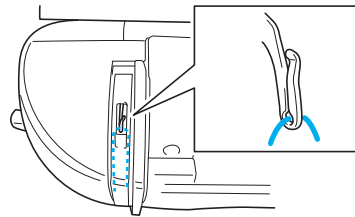

- 11** Pass the thread behind the needle bar thread guide.

The thread can easily be passed behind the needle bar thread guide by holding the thread in your left hand, then feeding the thread with your right hand, as shown.

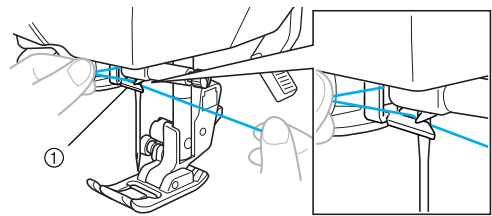

① Needle bar thread guide

Next, use the needle threader to thread the needle. Continue with the procedure in "Threading the needle" (page 34).

Threading the needle

This section describes how to thread the needle.



Memo

- The needle threader can be used with sewing machine needles 75/11 through 100/16.
- Thread with a thickness of 130/20 or thicker cannot be used with the needle threader.
- The needle threader cannot be used with the wing needle or the twin needle.
- If the needle threader cannot be used, refer to “Threading the needle manually (without using the needle threader)” (page 35).

- 1 Pull the end of the thread passed through the needle bar thread guide to the left, and then pass the thread through the thread guide disk from the front.**

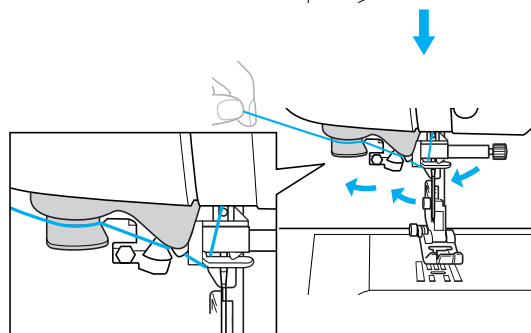
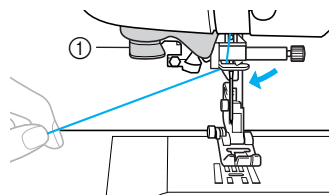

① Thread guide disk

- 2 Cut the thread with the thread cutter on the left side of the machine.**

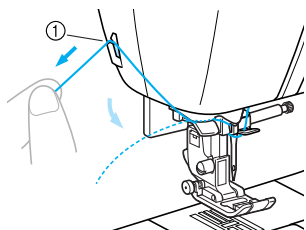

① Thread cutter



Note

- If the thread is pulled through and cannot be cut correctly, lower the presser foot so that the thread is held in place before cutting the thread. If this operation is performed, skip step 3.
- When using thread that quickly winds off the spool, such as metallic thread, it may be difficult to thread the needle if the thread is cut. Therefore, instead of using the thread cutter, pull out about 80 mm (approx. 3 inches) of thread after passing it through the thread guide disks (marked “7”).

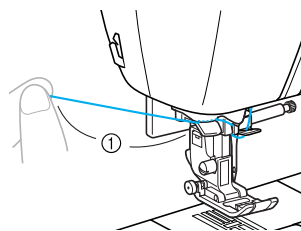

① 80 mm (3 inches) or more

- 3 Lower the presser foot lever to lower the presser foot.**

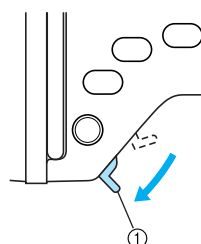

① Presser foot lever

- 4 Lower the needle threader lever on the left side of the machine until it clicks, and then slowly return the lever to its original position.**

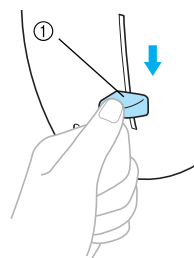

① Needle threader lever

- ▶ The thread is passed through the eye of the needle.



Note

- If the needle was not completely threaded, but a loop in the thread was formed in the eye of the needle, carefully pull the loop through the eye of the needle to pull out the end of the thread.

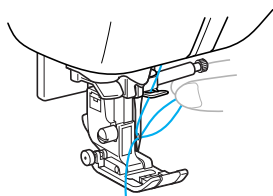

CAUTION

- When pulling out the thread, do not pull it with extreme force, otherwise the needle may break or bend.

5

Raise the presser foot lever, pass the end of the thread through the presser foot, and then pull out about 5 cm (2 inches) of thread toward the rear of the machine.

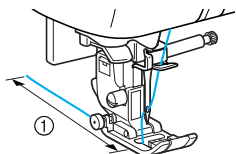

① 5 cm (2 inches)

- ▶ The upper threading is finished. Now that the upper threading and the lower threading are finished, you are ready to begin sewing.



Note

- If the needle is not raised, the needle threader cannot thread the needle. Be sure to press  ("Needle Position" button) to raise the needle before using the needle threader.

Threading the needle manually (without using the needle threader)

When using special thread, thread with a thickness of 130/20 or thicker, the wing needle or the twin needle which cannot be used with the needle threader, thread the needle as described below.

1

Thread the machine to the needle bar thread guide.

- For details, refer to "Upper Threading" (page 31).

2

Lower the presser foot lever.

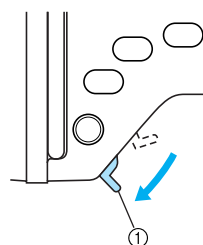

① Presser foot lever

3

Pass the thread through the eye of the needle from front to back.

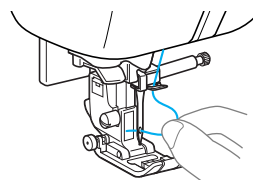

4

Raise the presser foot lever, pass the end of the thread through the presser foot, and then pull out about 5 cm (2 inches) of thread toward the rear of the machine.

Using the twin needle

With the twin needle, you can sew two parallel lines of the same stitch with two different threads. Both upper threads should have the same thickness and quality. Be sure to use the twin needle, the extra spool pin and the spool cap.

For details on the stitches that can be sewn with the twin needle, refer to “Stitch Setting Chart” (page 70).

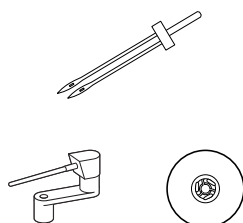

CAUTION

- Only use the twin needle (part code: X59296-121). Use of any other needle may bend the needle or damage the machine.
- Never use bent needles. Bent needles can easily break, possibly resulting in injuries.

1 Install the twin needle.

- For details on installing a needle, refer to “Replacing the needle” (page 42).

2 Thread the upper thread for the left needle eye.

- For details, refer to steps 1 through 11 of “Threading the upper thread” (page 32).

3 Manually thread the left needle with the upper thread.

Pass the thread through the eye of the needle from the front.

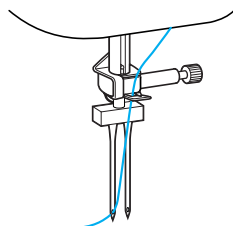

- The needle threader cannot be used with the twin needle. If the needle threader is used with the twin needle, the sewing machine may be damaged.

4 Insert the extra spool pin onto the bobbin winder shaft.

Insert the extra spool pin so that it is perpendicular to the bobbin winder shaft.

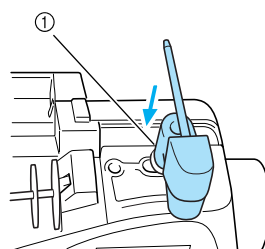

① Bobbin winder shaft

5 Swing down the spool pin so that it is horizontal.

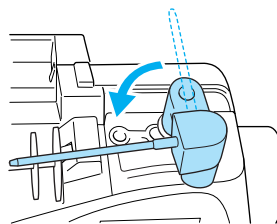

6 Place the upper thread spool for the needle on the right side onto the extra spool pin, and then secure it with the spool cap.

The thread should unroll from the top front of the spool.

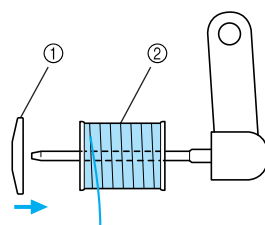

① Spool cap
② Spool

- 7** Thread the upper thread for the right side in the same way that the upper thread for the left side was threaded.

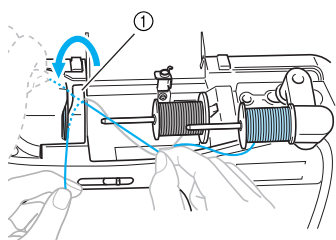

① Thread guide cover

- For details, refer to steps **8** through **10** of “Threading the upper thread” (page 33).

- 8** Without passing the thread through the needle bar thread guide, manually thread the right needle.

Pass the thread through the eye of the needle from the front.

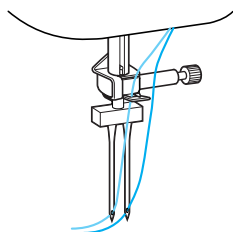

- The needle threader cannot be used with the twin needle. If the needle threader is used with the twin needle, the sewing machine may be damaged.

- 9** Attach zigzag foot “J”.

- For details on changing the presser foot, refer to “Replacing the Presser Foot” (page 44).

CAUTION

- When using the twin needle, be sure to attach zigzag foot “J”. If bunched stitches occur, use presser foot “N” or attach stabilizer material.

- 10** Turn on the sewing machine and select a stitch.

- For stitch selection see “Selecting stitching” (page 51).
- See “Stitch Setting Chart” (page 70) for stitches that use a twin needle.

Note

- When using the pintuck foot (sold separately) to sew straight pintucks with the twin needle, select the stitch with the center needle position.

CAUTION

- When using the twin needle, be sure to select an appropriate stitch, otherwise the needle may break or the machine may be damaged.
- After adjusting the stitch width, slowly turn the handwheel toward you (counterclockwise) and check that the needle does not touch the presser foot. If the needle hits the presser foot, the needle may bend or break.

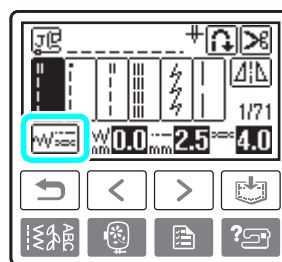

- 11** Press .

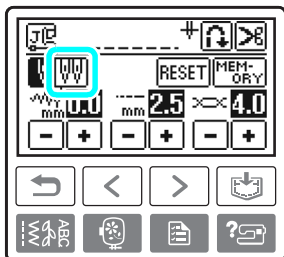

- ▶ The screen for setting the twin needle appears.

- 12 Press .



- ▶  displays in reverse highlight.
- If pressed again, it returns to .

The twin needle can now be used.

- 13 Press  (Back key).

- ▶ The initial screen appears again, and  appears.

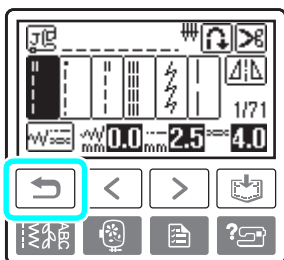

CAUTION

- When using the twin needle, be sure to select the twin needle setting, otherwise the needle may break or the machine may be damaged.

- 14 Start sewing.

- For details on starting to sew, refer to “Starting to sew” (page 53).
- ▶ Two lines of stitching are sewn parallel to each other.

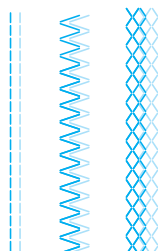

CAUTION

- When changing the sewing direction, press  (“Needle Position” button) to raise the needle from the fabric, and then raise the presser foot lever and turn the fabric. Otherwise the needle may break or the machine may be damaged.
- Do not try turning the fabric with the twin needle left down in the fabric, otherwise the needle may break or the machine may be damaged.

Pulling up the bobbin thread

When making gathers or before free-motion quilting, first pull up the bobbin thread as described below.

- 1 Insert the bobbin into the bobbin case.**
 - Refer to steps 1 through 5 of “Installing the bobbin” (page 29).
- 2 Pass the bobbin thread through the slot.**
Do not cut the thread with the cutter.

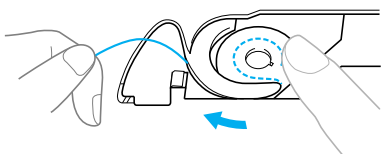

- 3 While lightly holding the upper thread with your left hand with the needle in the up-position, press  (“Needle Position” button) twice to lower and raise the needle.**

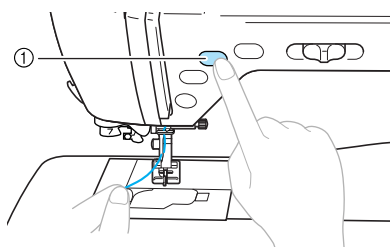

- ① “Needle Position” button
- ▶ The bobbin thread is looped around the upper thread and can be pulled up.

- 4 Carefully pull the upper thread upward to pull out the end of the bobbin thread.**

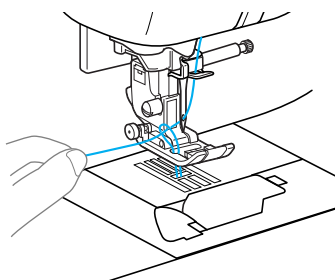

- 5 Pull out about 10-15 cm (4-5 inches) of the bobbin thread under the presser foot toward the rear of the machine.**

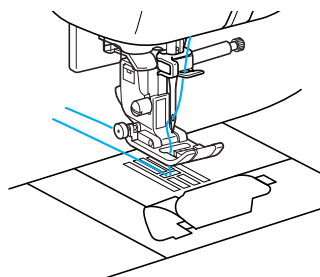

- 6 Reattach the bobbin cover.**
Insert the tab in the lower-left corner of the bobbin cover, and then lightly press down on the right side.

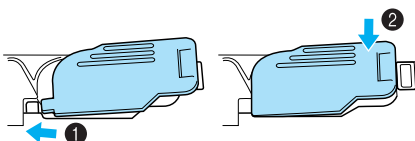

Replacing the Needle

This section describes how to replace the needle.

Needle precautions

Be sure to observe the following precautions concerning the handling of the needle. Failure to observe these precautions is extremely dangerous, for example, if the needle breaks and fragments are dispersed. Be sure to read and carefully follow the instructions below.



CAUTION

- **Only use home sewing machine needles. Use of any other needle may bend the needle or damage the machine.**
- **Never use bent needles. Bent needles can easily break, possibly resulting in injuries.**

Needle types and their uses

The sewing machine needle that should be used depends on the fabric and thread thickness. Refer to the following table when choosing the thread and needle appropriate for the fabric that you wish to sew.

Fabric Type/Application		Thread		Size of Needle
		Type	Weight	
Medium weight fabrics	Broadcloth	Cotton thread	60–80	75/11–90/14
	Taffeta	Synthetic thread		
	Flannel, Gabardine	Silk thread	50	
Thin fabrics	Lawn	Cotton thread	60–80	65/9–75/11
	Georgette	Synthetic thread		
	Challis, Satin	Silk thread	50	
Thick fabrics	Denim	Cotton thread	30–50	90/14–100/16
	Corduroy	Synthetic thread	50	
	Tweed	Silk thread		
Stretch fabrics	Jersey	Thread for knits	50–60	Ball point needle (gold colored) 75/11–90/14
	Tricot			
Easily frayed fabrics		Cotton thread	50–80	65/9–90/14
		Synthetic thread		
		Silk thread	50	
For top-stitching		Synthetic thread	30	90/14–100/16
		Silk thread		

■ Thread and needle number

The lower the thread number is, the larger the thread, and the larger the needle number, the larger the needle.

■ Ball point needle (gold colored)

To avoid skipped stitches use ball point needles with stretch fabrics.

■ Transparent nylon thread

Use a 90/14 to 100/16 needle, regardless of the fabric or thread.

■ Embroidery needles

Use a 75/11 home sewing machine needle. When embroidering on thick fabrics such as denim, use a 90/14 or 100/16 home sewing machine needle.

- A 75/11 needle is already installed when the sewing machine is purchased.

! CAUTION

- The appropriate fabric, thread and needle combinations are shown in the table above. If the combination of the fabric, thread and needle is not correct, particularly when sewing thick fabrics (such as denim) with thin needles (such as 65/9 to 75/11), the needle may bend or break. In addition, the stitching may be uneven or puckered or there may be skipped stitches.

Checking the needle

Sewing with a bent needle is extremely dangerous since the needle may break while the machine is being operated.

Before using the needle, place the flat side of the needle on a flat surface and check that the distance between the needle and the flat surface is even.

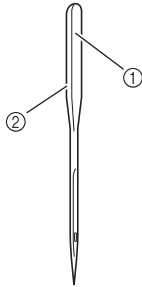

- ① Flat side
- ② Needle type marking

CAUTION

- If the distance between the needle and the flat surface is not even, the needle is bent. Do not use a bent needle.

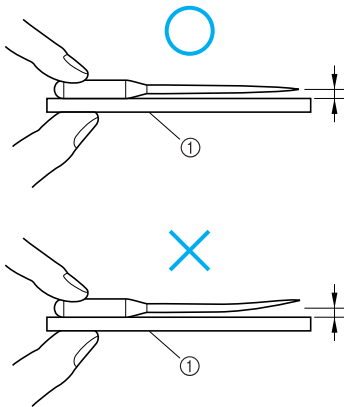

- ① Flat surface

Replacing the needle

Replace the needle as described below. Use the screwdriver and a needle that has been determined to be straight according to the instructions in "Checking the needle".

- 1 Press  ("Needle Position" button) once or twice to raise the needle.

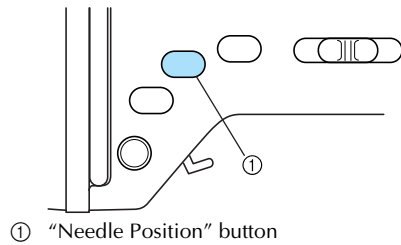

- ① "Needle Position" button

- 2 Turn off the sewing machine.

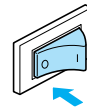

CAUTION

- Before replacing the needle, be sure to turn off the sewing machine, otherwise injuries may occur if  ("Start/Stop" button) is accidentally pressed and the machine starts sewing.

- 3 Place fabric or paper under the presser foot to cover the hole in the needle plate.

Note

- Before replacing the needle, cover the hole in the needle plate with fabric or paper to prevent the needle from falling into the machine.

- 4 Lower the presser foot lever.

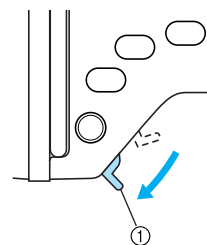

- ① Presser foot lever

- 5** Hold the needle with your left hand, and then use a screwdriver to turn the needle clamp screw toward you (counterclockwise) to remove the needle.

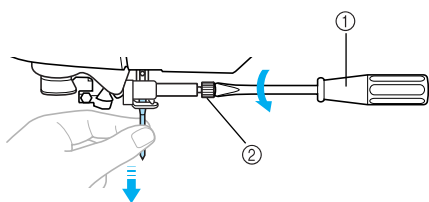

- ① Screwdriver
② Needle clamp screw

- Do not apply a strong force when loosening or tightening the needle clamp screw, otherwise certain parts of the sewing machine may be damaged.

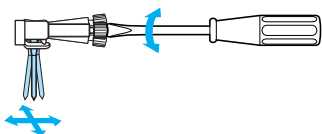

- 6** With the flat side of the needle toward the rear of the machine, insert the needle until it touches the needle stopper.

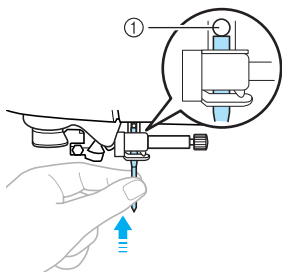

- ① Needle stopper

- 7** While holding the needle with your left hand, use the screwdriver to tighten the needle clamp screw.

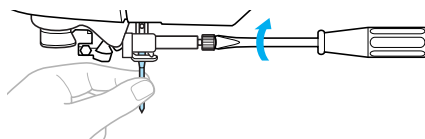

Install the twin needle in the same way.

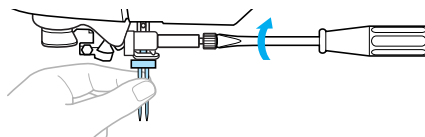

! CAUTION

- Be sure to insert the needle until it touches the needle stopper and securely tighten the needle clamp screw with the screwdriver, otherwise the needle may break or damage may result.

Replacing the Presser Foot

This section describes how to replace the presser foot.

Presser foot precautions

Be sure to observe the following precautions concerning the presser feet.

! CAUTION

- Use the presser foot appropriate for the type of stitch that you wish to sew, otherwise the needle may hit the presser foot, causing the needle to bend or break.
- Only use presser feet designed specifically for this sewing machine. Use of any other presser foot may result in injuries or damage to the machine.

Replacing the presser foot

Replace the presser foot as described below.

- 1 Press  ("Needle Position" button) once or twice to raise the needle.

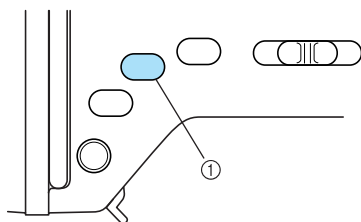

① "Needle Position" button

- 2 Turn off the sewing machine.

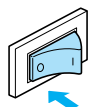

! CAUTION

- Before replacing the presser foot, be sure to turn off the sewing machine, otherwise injuries may occur if  ("Start/Stop" button) is accidentally pressed and the machine starts sewing.

- 3 Raise the presser foot lever.

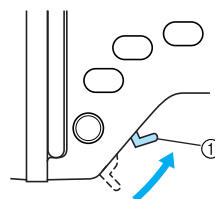

① Presser foot lever

▶ The presser foot is raised.

- 4 Press the black button at the back of the presser foot holder.

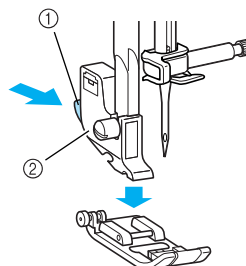

① Black button

② Presser foot holder

▶ The presser foot holder releases the presser foot.

5 Place a different presser foot below the holder so that the presser foot pin is aligned with the notch in the holder.

Position the presser foot so the letter indicating the presser foot type (A, G, I, J, M, N or R) is positioned to be read.

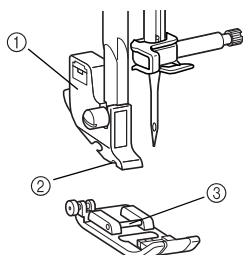

- ① Presser foot holder
- ② Notch
- ③ Pin

6 Slowly lower the presser foot lever so that the presser foot pin snaps into the notch in the presser foot holder.

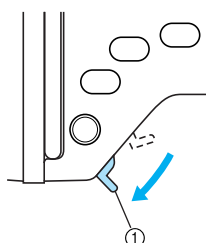

- ① Presser foot lever
- ▶ The presser foot is attached.



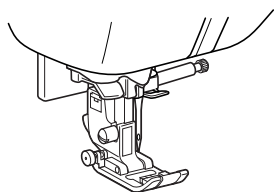



7 Raise the presser foot lever to check that the presser foot is securely attached.

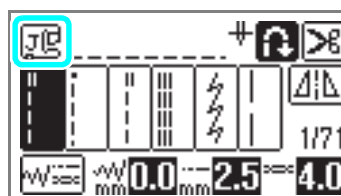

Note

- When a stitch is selected, the icon for the presser foot that should be used appears in the screen. Check that the correct presser foot is attached before starting to sew. If the wrong presser foot is installed, turn off the sewing machine, attach the correct presser foot, and then select the desired stitch again.



-  Buttonhole foot "A"
-  Overcasting foot "G"
-  Zigzag foot "J"
-  Button fitting foot "M"
-  Monogramming foot "N"
-  Blind stitch foot "R"
-  Side cutter "S"

- For details on the presser foot that should be used with the selected stitch, refer to "Stitch Setting Chart" (page 70).

Removing and attaching the presser foot holder

Remove the presser foot holder when cleaning the sewing machine or when installing a presser foot that does not use the presser foot holder, such as the embroidery foot and optional quilting foot. Use the screwdriver to remove the presser foot holder.

1 Remove the presser foot.

- For details, refer to “Replacing the presser foot” (page 44).

2 Use the screwdriver to loosen the presser foot holder screw.

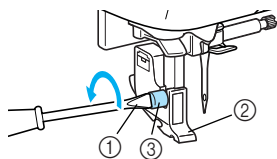

- ① Screwdriver
- ② Presser foot holder
- ③ Presser foot holder screw

■ Attaching the presser foot holder

1 Raise the presser foot lever.

2 Align the presser foot holder with the lower-left side of the presser bar.

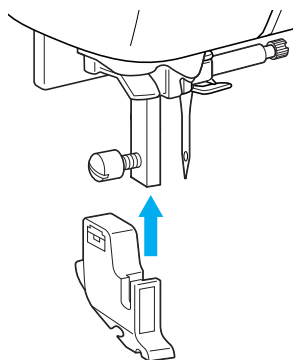

3 Hold the presser foot holder in place with your right hand, and then tighten the screw using the screwdriver in your left hand.

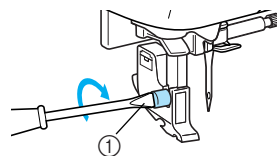

- ① Screwdriver

Note

- If the presser foot holder is not correctly installed, the thread tension will be incorrect.

Sewing Cylindrical Pieces

Free-arm sewing makes sewing cylindrical pieces easy.

Free-arm sewing

Removing the flat bed attachment allows for free-arm sewing, making it easier to sew cylindrical pieces such as sleeve cuffs and pant legs.

- 1 Pull the flat bed attachment off to the left.**

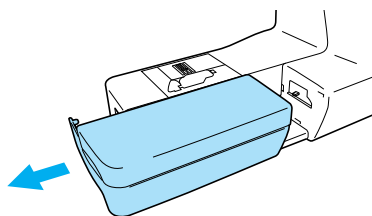

- ▶ With the flat bed attachment removed, free-arm sewing is possible.

- 2 Slide the part that you wish to sew onto the arm, and then sew from the top.**

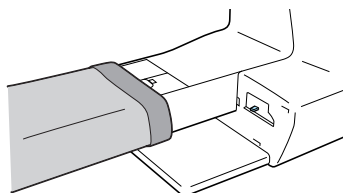

- 3 When you are finished with free-arm sewing, install the flat bed attachment back in its original position.**

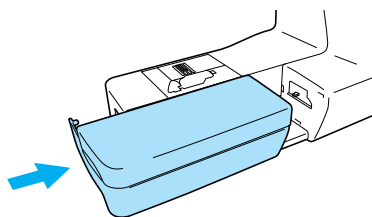

2

SEWING BASICS

The necessary preparations for sewing are described in this chapter.

Sewing.....	50
General sewing procedure	50
Selecting stitching	51
Positioning the fabric	52
Starting to sew	53
Securing the stitching.....	55
Cutting the thread	56
Setting the Stitch	58
Adjusting the stitch width	58
Adjusting the stitch length.....	59
Adjusting the thread tension	59
Useful Functions.....	61
Automatically sewing reverse/reinforcement stitches	61
Automatically cutting the thread.....	62
Mirroring stitches.....	63
Useful Sewing Tips	64
Trial sewing.....	64
Changing the sewing direction	64
Sewing curves	64
Adjusting the presser foot pressure	64
Sewing thick fabrics	65
Sewing thin fabrics.....	66
Sewing stretch fabrics	66
Sewing leathers or vinyl fabrics.....	66
Sewing an even seam allowance	66
Hands-free raising and lowering of the presser foot.....	67

Sewing

Basic sewing operations are described below.

Before operating the sewing machine, read the following precautions.

CAUTION

- While the machine is in operation, pay special attention to the needle location. In addition, keep your hands away from all moving parts such as the needle and handwheel, otherwise injuries may occur.
- Do not pull or push the fabric too hard while sewing, otherwise injuries may occur or the needle may break.
- Never use bent needles. Bent needles can easily break, possibly resulting in injuries.
- Make sure that the needle does not strike basting pins, otherwise the needle may break or bend.

General sewing procedure

Follow the basic procedures below to sew.

1	Turn on the machine.	Turn on the sewing machine. For details on turning on the machine, refer to “Turning on the machine” (page 19).
↓		
2	Select the stitch.	Select the stitch appropriate for the area to be sewn. For details on selecting a stitch, refer to “Selecting stitching” (page 51).
↓		
3	Attach the presser foot.	Attach the presser foot appropriate for the stitch. (Be sure to turn off the machine before replacing the presser foot.) For details on replacing the presser foot, refer to “Replacing the presser foot” (page 44).
↓		
4	Position the fabric.	Place the area to be sewn under the presser foot. Be sure that the fabric pieces are sewn in the correct order and that the right and wrong sides of the fabric are aligned correctly. For details on positioning the fabric, refer to “Positioning the fabric” (page 52).
↓		
5	Start sewing.	Start sewing. For details on starting to sew, refer to “Starting to sew” (page 53).
↓		
6	Cut the thread.	Cut the thread at the end of sewing. For details on cutting the thread, refer to “Cutting the thread” (page 56).

Selecting stitching

Stitches are selected using LCD operations. There are 71 utility stitches. Right after turning the power on, the straight stitch (left needle position) is selected. The machine can also be set to select the straight stitch (center needle position). For details on changing the setting, refer to page 21.

1 Determine the stitch to be used, and get the matching presser foot ready.

- Refer to “Stitch Setting Chart” (page 70).

2 Attach the presser foot.

The machine comes with zigzag foot “J” attached.

- For details, refer to “Replacing the presser foot” (page 44).

CAUTION

- Use the presser foot appropriate for the stitch. If the wrong presser foot is used, the needle may hit the presser foot and break or bend.

3 Turn on the sewing machine.

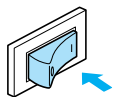

- ▶ The straight stitch (left needle position) is shown selected in the LCD.

- When an animation is displayed on the screen, touch the screen with your finger.

4 Select a stitch.

[<] (Previous page key) displays the previous screen, and [>] (Next page key) displays the next screen.

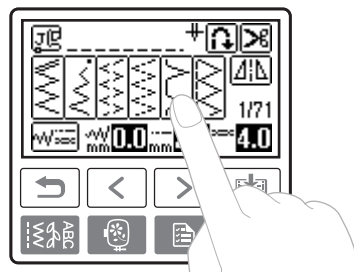
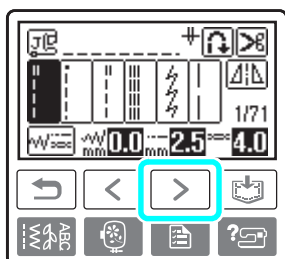

- Example: 11 is selected:

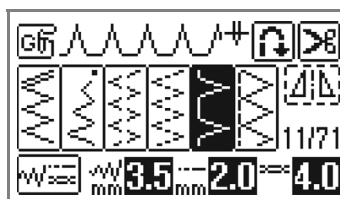

- ▶ The stitch is selected, and the stitch number and settings are displayed.

5 If necessary, specify the setting for automatic reverse/reinforcement stitching and adjust the stitch length, etc.

Memo

- Uses of stitches and other stitch selections are explained in “UTILITY STITCHES” (page 69).
- Automatic reverse/reinforcement stitching and other settings are explained in “Useful Functions” (page 61).
- The procedures for specifying the thread tension are described in “Adjusting the thread tension” (page 59).
- Procedures for changing the stitch width and length are described in “Adjusting the stitch width” (page 58) and “Adjusting the stitch length” (page 59).

Note

- When a stitch is selected, the icon for the presser foot that should be used appears on the screen. For details, refer to “Replacing the presser foot” (page 44). Check that the correct presser foot is attached before starting to sew. If the wrong presser foot is installed, turn off the sewing machine, attach the correct presser foot, and then select the desired stitch again.

Positioning the fabric

Be sure that the fabric pieces are sewn in the correct order and that the right and wrong sides of the fabric are aligned correctly.

- 1 Turn on the sewing machine.

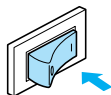

- 2 Press  ("Needle Position" button) once or twice to raise the needle.

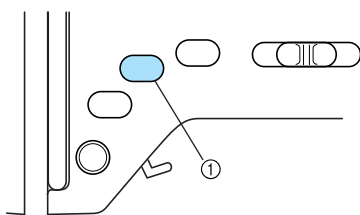

① "Needle Position" button

- 3 Place the fabric under the presser foot.

- If the seam allowance is positioned on the right side, sewing in a straight line is easier and the extra fabric does not get in the way.

- 4 While holding the end of the thread and the fabric with your left hand, turn the handwheel toward you (counterclockwise) with your right hand to lower the needle to the starting point of the stitching.

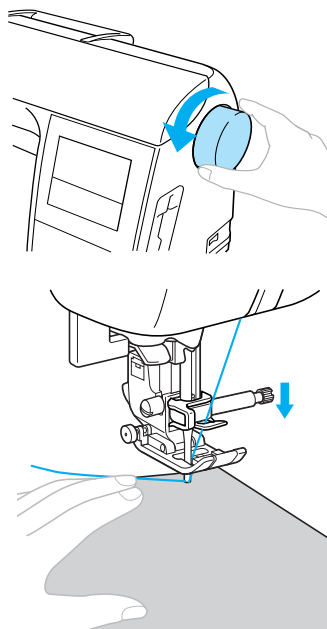

- 5 Lower the presser foot lever.

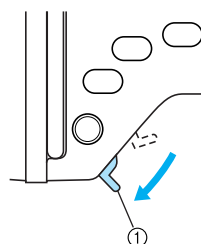

① Presser foot lever

- ▶ The fabric is now positioned to be sewn.

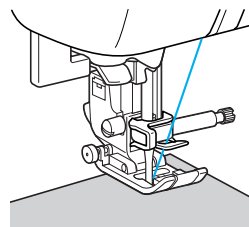

Starting to sew

Once you are ready to start sewing, you can start the sewing machine. The sewing speed can be adjusted using either the sewing speed controller or the foot controller.



Note

- When the foot controller is plugged in, Ⓜ (“Start/Stop” button) cannot be used to start or stop sewing.

■ Using the operation button

Sewing can be started and stopped using the operation button Ⓜ (“Start/Stop” button).

① Slide the sewing speed controller to the left or right to select the desired sewing speed.

Slide the sewing speed controller to the left to sew at a slower speed, or slide the speed controller to the right to sew at a faster speed.

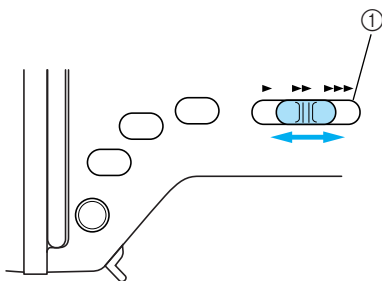

① Sewing speed controller

② Press Ⓜ (“Start/Stop” button) once.

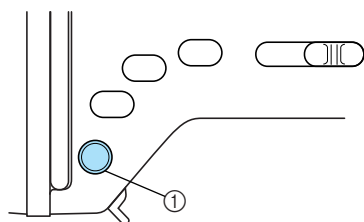

① “Start/Stop” button

- ▶ The machine starts sewing.

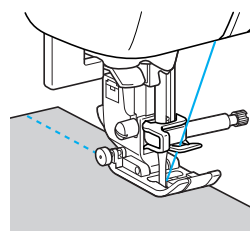

- If you continue to hold the Ⓜ (“Start/Stop” button) pressed immediately after the sewing starts, the machine will sew at a slow speed.

③ When the end of the stitching is reached, press Ⓜ (“Start/Stop” button) once.

- ▶ The machine stops sewing with the needle down (in the fabric).

④ When you have finished sewing, press Ⓜ (“Needle Position” button).

- ▶ The needle is raised.

⑤ Cut the threads.

- For details, refer to “Cutting the thread” (page 56).



Note

- This machine will automatically stop when the bobbin becomes almost empty. When the machine stops, replace the bobbin thread, and then press Ⓜ (“Start/Stop” button) to begin sewing again.

■ Using the foot controller

Sewing can be started and stopped using the foot controller.

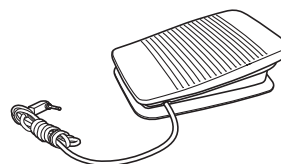

① Turn off the sewing machine.

When connecting the foot controller, be sure to turn off the sewing machine in order to prevent the machine from accidentally being started.

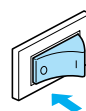

- 2** Insert the foot controller plug into its jack on the right side of the sewing machine.

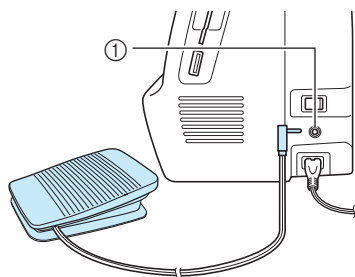

① Foot controller jack

- 3** Turn on the sewing machine.

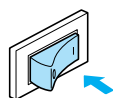

- 4** Slide the sewing speed controller to the left or right to select the foot controller's maximum sewing speed.

Slide the sewing speed controller to the left to select a lower maximum sewing speed, or slide the speed controller to the right to select a higher maximum sewing speed.

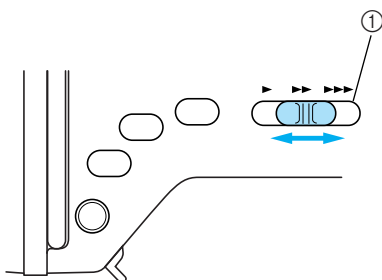

① Sewing speed controller

- The speed set using the sewing speed controller will be the foot controller's maximum sewing speed.

- 5** Once you are ready to start sewing, slowly press down on the foot controller.

Pressing down on the foot controller increases the sewing speed; releasing the pressure on the foot controller decreases the sewing speed.

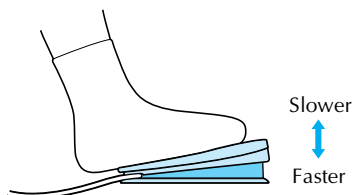

- Slowly press down on the foot controller. Pressing it down hard starts sewing too quickly.
- ▶ The machine starts sewing.

- 6** When the end of the stitching is reached, completely release the foot controller.

- ▶ The machine stops sewing with the needle lowered (in the fabric).

- 7** When you have finished sewing, press  ("Needle Position" button).

- ▶ The needle is raised.

- 8** Cut the threads.

- For details, refer to "Cutting the thread" (page 56).



Memo

- When the foot controller is plugged in,  ("Start/Stop" button) cannot be used to start or stop sewing.
- When sewing is stopped, the needle remains lowered (in the fabric). The machine can be set so that the needle will stay up when sewing is stopped. For details on setting the machine so that the needle stays up when sewing is stopped, refer to "Changing the machine settings" (page 21).

CAUTION

- Do not allow thread or dust to accumulate in the foot controller, otherwise a fire or an electric shock may occur.
- Do not place objects on the foot controller, otherwise damage to the machine or injuries may occur.
- If the machine is not to be used for a long period of time, unplug the foot controller, otherwise a fire or an electric shock may occur.

Securing the stitching

When sewing with the straight stitch, for example, at the end of an opening or where seams do not overlap, use reverse stitching or reinforcement stitching to secure the end of the thread.

- 1 Lower the needle into the fabric at the beginning of the stitching, and then lower the presser foot lever.

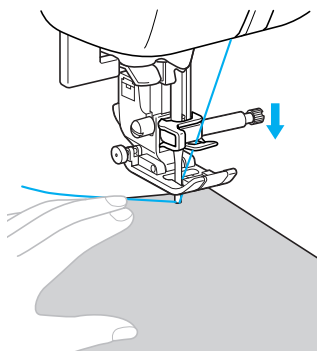

- 2 Press  ("Start/Stop" button) or press down on the foot controller.

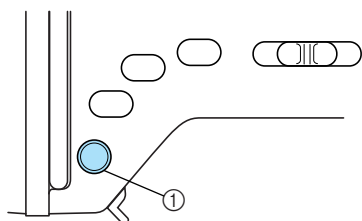

At this time, if  ("Start/Stop" button) is held down, the machine sews at a slow speed.



- 1 "Start/Stop" button

- For details, refer to "Starting to sew" (page 53).

▶ The machine starts sewing.

- 3 After sewing 3 to 5 stitches, press  ("Reverse/Reinforcement Stitch" button). Keep  ("Reverse/Reinforcement Stitch" button) held down until you reach the beginning of the stitching.

- The machine sews at a slow speed when  ("Reverse/Reinforcement Stitch" button) is held down.

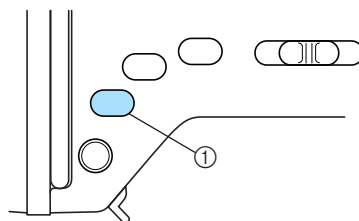

- 1 "Reverse/Reinforcement Stitch" button

▶ While  ("Reverse/Reinforcement Stitch" button) is held down, reverse stitches are sewn.

- 4 After sewing back to the beginning of the stitching, release  ("Reverse/Reinforcement Stitch" button).

▶ The machine stops sewing.

- 5 Press  ("Start/Stop" button), or press down on the foot controller.

▶ The machine starts sewing in the normal sewing direction.

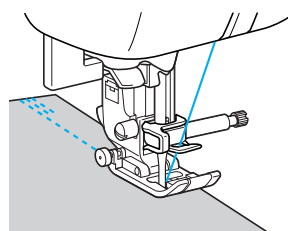

- 6 When the end of the stitching is reached, press  ("Reverse/Reinforcement Stitch" button).

Keep  ("Reverse/Reinforcement Stitch" button) held down until 3 to 5 reverse stitches are sewn.

▶ While  ("Reverse/Reinforcement Stitch" button) is held down, reverse stitches are sewn.

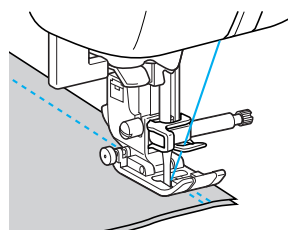

- 7** After 3 to 5 reverse stitches have been sewn, release  (“Reverse/Reinforcement Stitch” button).

▶ The machine stops sewing.

- 8** Press  (“Start/Stop” button), or press down on the foot controller.

At this time, if  (“Start/Stop” button) is held down, the machine sews at a slow speed.



▶ The machine starts sewing in the normal sewing direction.

- 9** After sewing to the end of the stitching, the sewing machine stops.

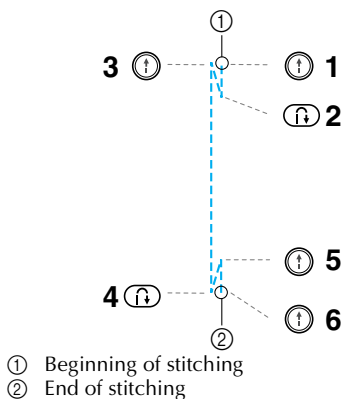
Press  (“Start/Stop” button) or release foot controller.



■ Sewing stitches

Reverse stitches are preset for the   and  stitches.

When  (“Reverse/Reinforcement Stitch” button) is pressed with stitches other than these, reinforcement stitches are used. Reinforcement stitches are 3 to 5 stitches sewn on top of each other in one place.

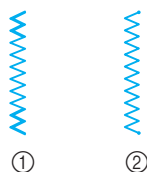

- ① Reverse stitching
② Reinforcement stitching



Memo

- The sewing machine can be set to automatically sew reverse or reinforcement stitches at the beginning and end of the stitching. For details, refer to “Automatically sewing reverse/reinforcement stitches” (page 61).

Cutting the thread

When you have finished sewing, cut the threads.

- Using  (“Thread Cutter” button)

- 1** When you wish to finish the stitching, press  (“Thread Cutter” button) once.

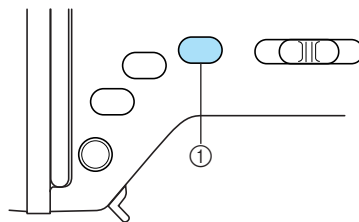

- ① “Thread Cutter” button

▶ The threads are cut and the needle is raised.

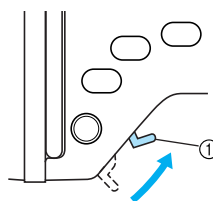

- 2** Raise the presser foot lever, then remove the fabric.



- ① Presser foot lever



CAUTION

- Do not press  (“Thread Cutter” button) after threads have already been cut, otherwise the needle may break, the threads may become tangled or damage to the machine may occur.
- Do not press  (“Thread Cutter” button) if there is no fabric under the presser foot or while the machine is sewing, otherwise damage to the machine may occur.



Memo

- The machine can be set so that the threads will be cut when sewing is finished. For details on setting the machine so that the threads are cut automatically, refer to “Automatically cutting the thread” (page 62).

■ Using the thread cutter

When sewing with thread thicker than #30, nylon or metallic threads, or other special threads, use the thread cutter on the side of the machine to cut the threads.

- 1 When you wish to finish the stitching and the sewing machine is stopped, press  ("Needle Position" button) once to raise the needle.

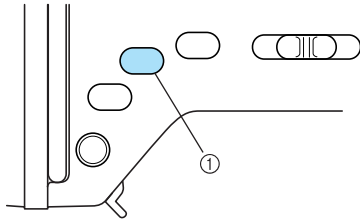

- 1 "Needle Position" button
- ▶ The needle is raised.

- 2 Raise the presser foot lever.

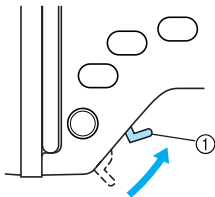

- 1 Presser foot lever

- 3 Pull the fabric to the left side of the machine, and then pass the threads through the thread cutter to cut them.

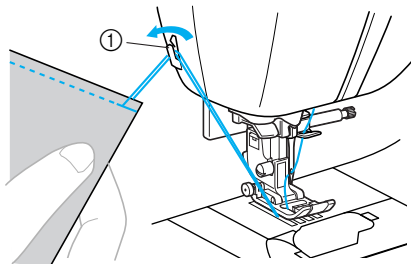

- 1 Thread cutter

Setting the Stitch

This machine is preset with the default settings for the stitch width, stitch length, and upper thread tension for each stitch. However, you can change any of the settings by pressing  in the screen, then following the procedure described in this section.

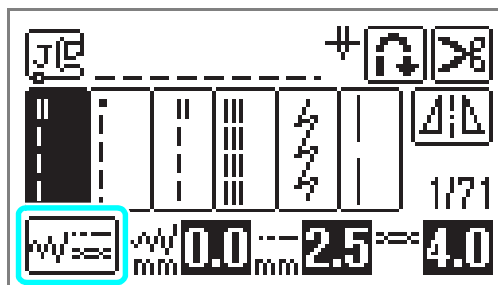

Note

- If the thread tension cannot be adjusted as desired, refer to “Troubleshooting” (page 188).
- Settings for some stitches cannot be changed. For details, refer to “Stitch Setting Chart” (page 70).
- Stitch settings return to their defaults if they are changed, when the machine is turned off or a different stitch is selected before the stitch setting is saved.

Adjusting the stitch width

The stitch width (zigzag width) can be adjusted to make the stitch wider or narrower.



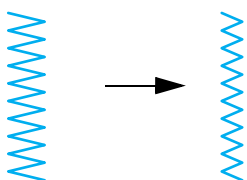

Each press of  makes the zigzag stitch narrower.

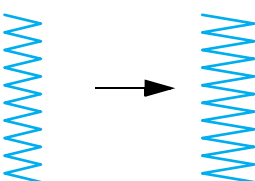

Each press of  makes the zigzag stitch wider.



Memo

- Press  to return the setting to its default.
- If the straight stitch (left needle position or triple stretch stitch) was selected, changing the stitch width changes the needle position. Increasing the width moves the needle to the right; reducing the width moves the needle to the left.
- The sewing machine can be set so that the stitch width can easily be changed with the sewing speed controller. For details, refer to “Satin stitching using the sewing speed controller” (page 111).
-  means the setting cannot be adjusted.



CAUTION

- After adjusting the stitch width, slowly turn the handwheel toward you (counterclockwise) and check that the needle does not touch the presser foot. If the needle hits the presser foot, the needle may bend or break.

Adjusting the stitch length

The stitch length can be adjusted to make the stitch longer or shorter.

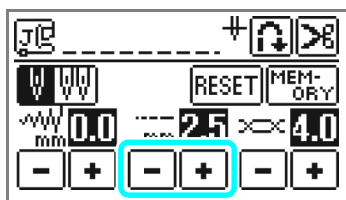

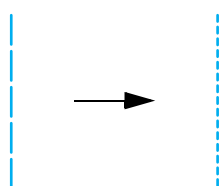

Each press of  makes the stitch shorter.

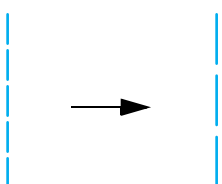

Each press of  makes the stitch longer.



Memo

- Press  to return the setting to its default.
-  means the setting cannot be adjusted.

CAUTION

- If the stitches are bunched together, increase the stitch length. Continuing to sew with the stitches bunched together may result in the needle bending or breaking.

Adjusting the thread tension

You may need to change the thread tension, depending on the fabric and thread being used.

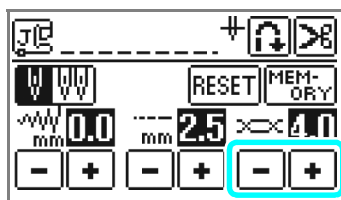

Correct thread tension

The upper thread and the bobbin thread should cross near the center of the fabric. Only the upper thread should be visible from the right side of the fabric, and only the bobbin thread should be visible from the wrong side of the fabric.

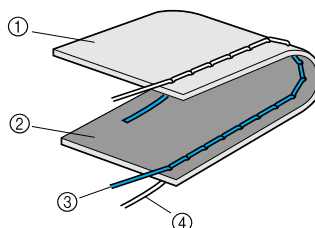

- ① Wrong side of fabric
- ② Right side of fabric
- ③ Upper thread
- ④ Bobbin thread

Upper thread is too tight

If the bobbin thread is visible from the right side of the fabric, the upper thread is too tight.

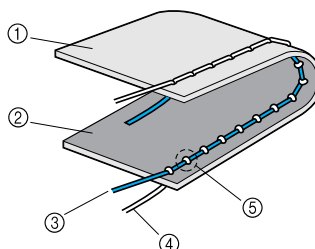

- ① Wrong side of fabric
- ② Right side of fabric
- ③ Upper thread
- ④ Bobbin thread
- ⑤ The bobbin thread is visible from the right side of the fabric.

Each press of  makes the thread tension looser.

■ Upper thread is too loose

If the upper thread is visible from the wrong side of the fabric, the upper thread is too loose.

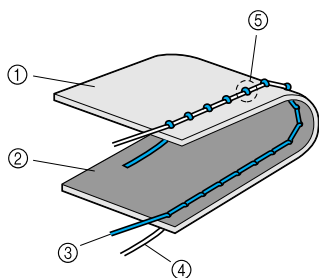

- ① Wrong side of fabric
- ② Right side of fabric
- ③ Upper thread
- ④ Bobbin thread
- ⑤ The upper thread is visible from the wrong side of the fabric.

Each press of **+** makes the thread tension tighter.



Memo

- Press **RESET** to return the setting to its default.



Note

- If the upper thread is not threaded correctly or the bobbin is not installed correctly, it may not be possible to set the correct thread tension. If the correct thread tension cannot be achieved, rethread the upper thread and insert the bobbin correctly.

Useful Functions

Functions useful in improving sewing efficiency are described below.

Automatically sewing reverse/reinforcement stitches

The sewing machine can be set to automatically sew reverse or reinforcement stitches at the beginning and end of the stitching. Whether reverse stitches or reinforcement stitches are sewn depends on the stitch that is selected. For details, refer to “Stitch Setting Chart” (page 70).

1 Turn on the sewing machine.

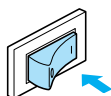

- ▶ The LCD comes on.

2 Select a stitch.

- For details on selecting a stitch, refer to “Selecting stitching” (page 51).

3 Press on the LCD.

This step is not necessary if a stitch such as those for sewing buttonholes and bar tacks is selected where reinforcement stitches are automatically sewn.

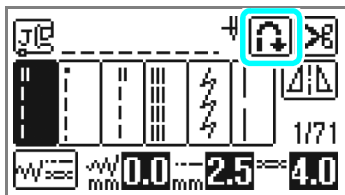

- ▶ It turns to , and the sewing machine is set for automatic reverse/reinforcement stitching.

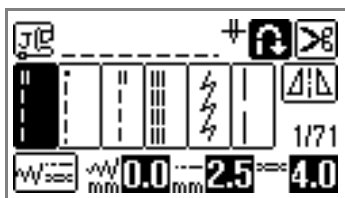

- To turn automatic reverse/reinforcement stitching off, press .
- When the sewing machine is turned off, the automatic reverse/reinforcement stitching setting is cancelled.

4 Position the fabric under the presser foot, and then press (“Start/Stop” button) once.

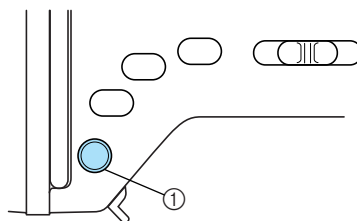

- ① “Start/Stop” button

- ▶ After reverse/reinforcement stitches are sewn, the machine starts sewing.

5 After reaching the end of the stitching, press (“Reverse/Reinforcement Stitch” button) once.

This step is not necessary if a stitch such as those for sewing buttonholes and bar tacks is selected where reinforcement stitches are automatically sewn.

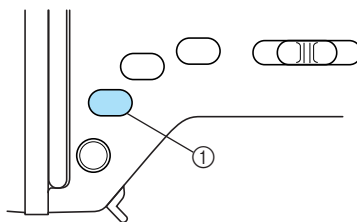

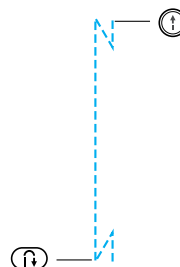

- ① “Reverse/Reinforcement Stitch” button

- ▶ After reverse/reinforcement stitches are sewn, the sewing machine stops.



Memo

- Reverse/reinforcement stitches **WILL NOT** be sewn until  (“Reverse/Reinforcement Stitch” button) is pressed.  (“Start/Stop” button) may be pressed to stop stitching when needed such as for pivoting corners.

Automatically cutting the thread

The sewing machine can be set to automatically cut the threads at the end of the stitching. This is called “programmed thread-cutting”. If programmed thread-cutting is set, automatic reverse/reinforcement stitching is also set.

1 Turn on the sewing machine.

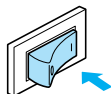



- ▶ The LCD comes on.

2 Select a stitch.

- For details on selecting a stitch, refer to “Selecting stitching” (page 51).

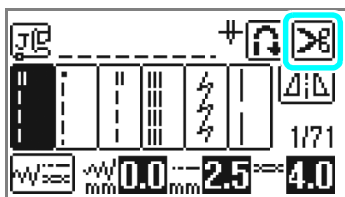
3 Press on the screen.



- ▶ You get  , and the sewing machine is set for programmed thread-cutting and automatic reverse/reinforcement stitching.

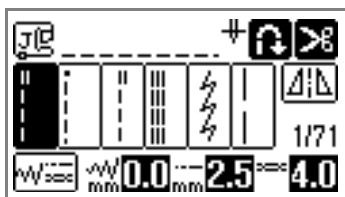

- To turn programmed thread cutting off, press .

4 Set the fabric in place, and press (“Start/Stop” button) once.

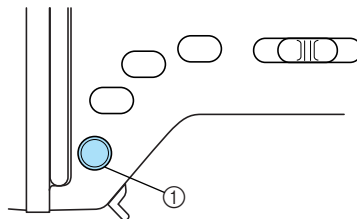

- ① “Start/Stop” button

- ▶ Stitching starts after reverse stitching or reinforcement stitching.



5 Once you have reached the end of the stitching, press (“Reverse/Reinforcement Stitch” button) once.

If stitching, such as buttonholes and bar tacking, that includes reinforcement stitching has been selected, this operation is unnecessary.

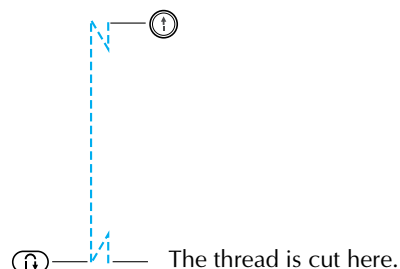
- ▶ After the reverse stitching or reinforcement stitching has been done, the sewing machine stops, and the thread is cut.



Memo

- Reverse/reinforcement stitches **WILL NOT** be sewing and the thread will not automatically be cut until  (“Reverse/Reinforcement Stitch” button) is pressed.  (“Start/Stop” button) may be pressed to stop stitching when needed such as for pivoting corners.
- If the power is turned off, programmed thread-cutting will be turned off.

Mirroring stitches

You can sew the mirror image of a stitch horizontally (left and right).

1 Turn on the sewing machine.

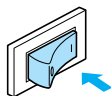



▶ The LCD comes on.

2 Select a stitch.

- For details on selecting a stitch, refer to “Selecting stitching” (page 51).

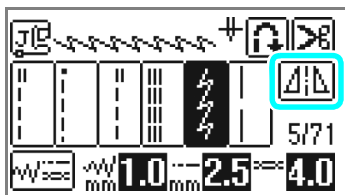
3 Press on the screen.



▶ It turns to , and the pattern displayed at the top of the screen is mirrored.

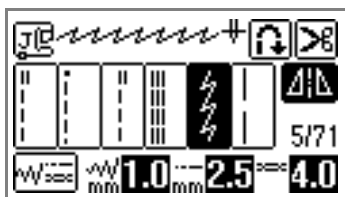

- To turn the mirrored stitching off, press .



Memo

- Mirroring is not possible for buttonholes and other stitches where  shows.
- When the sewing machine is turned off, the mirroring setting is cancelled.

Useful Sewing Tips

Various ways to achieve better results for your sewing projects are described below. Refer to these tips when sewing your project.

Trial sewing

After you have set up the machine with the thread and needle appropriate for the type of fabric being sewn, the machine automatically sets the thread tension and stitch length and width for the stitch that is selected. However, a trial piece of fabric should be sewn since, depending on the type of fabric and stitching being sewn, the desired results may not be achieved.

For the trial sewing, use a piece of fabric and thread that are the same as those used for your project, and check the thread tension and stitch length and width. Since the results differ depending on the type of stitching and the number of layers of fabric sewn, perform the trial sewing under the same conditions that will be used with your project.

Changing the sewing direction

1 When the stitching reaches a corner, stop the sewing machine.
Leave the needle lowered (in the fabric). If the needle remained up when the machine stopped sewing, press  (“Needle Position” button) to lower the needle.

2 Raise the presser foot lever, and then turn the fabric.
Turn the fabric using the needle as a pivot.

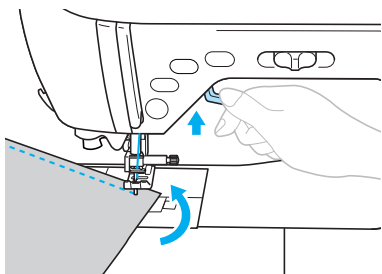

3 Lower the presser foot lever and continue sewing.

Sewing curves

Stop sewing, and then slightly change the sewing direction to sew around the curve. For details on sewing with an even seam allowance, refer to “Sewing an even seam allowance” (page 66).

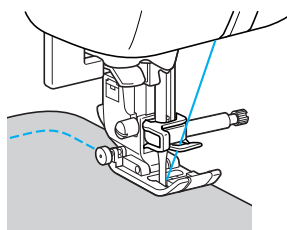

When sewing along a curve while using a zigzag stitch, select a shorter stitch length in order to obtain a finer stitch.

Adjusting the presser foot pressure

The presser foot pressure (the amount of pressure applied to the fabric by the presser foot) can be adjusted. For best results, increase the pressure when sewing thin fabrics, and decrease the pressure when sewing thick fabrics.

1 Lower the presser foot lever to lower the presser foot.

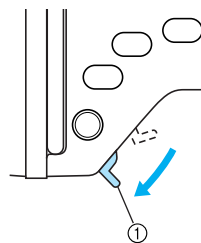

① Presser foot lever

- 2** Turn the presser foot pressure dial at the back of the machine to adjust the pressure of the presser foot.

The presser foot pressure can be set to one of four levels (between 1 and 4). The larger the setting, the stronger the pressure. Use setting 1 or 2 for thick fabrics, use setting 3 or 4 for thinner fabrics.

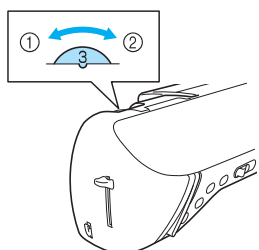

- ① Strong
- ② Weak

- 3** When you are finished sewing, reset the dial to 3 (standard).

Sewing thick fabrics

■ If the fabric does not fit under the presser foot

If the fabric does not fit easily under the presser foot, raise the presser foot lever even higher to bring the presser foot to its highest position.

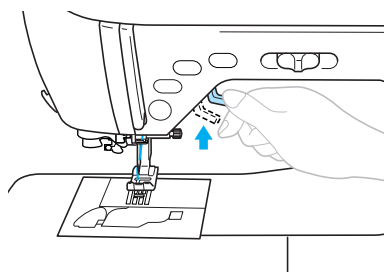

■ If thick seams are being sewn and the fabric does not feed at the beginning of stitching

Zigzag foot "J" is equipped with a feature that keeps the presser foot level.

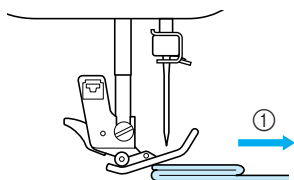

- ① Sewing direction

- 1** When you encounter a seam that is too thick to feed under the foot, raise the presser foot lever.

- 2** Press the black button (presser foot holding pin) on the left side of zigzag foot "J". Keep the button held in and lower the presser foot.

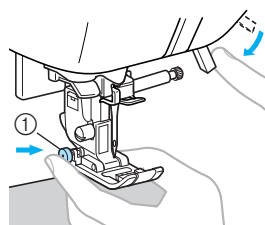

- ① Presser foot holding pin

Note

- The presser foot needs to be in a level position before pressing the black button (presser foot holding pin) on the left side of zigzag foot "J".

- 3** Release the button. The foot will lock in place level with the seam, allowing the fabric to feed.

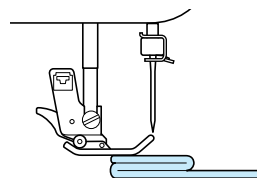

- ▶ Once the trouble spot has been passed, the foot will return to its normal position.

! CAUTION

- If fabric more than 6 mm (15/64 inch) thick is sewn or if the fabric is pushed with too much force, the needle may bend or break.

Sewing thin fabrics

When sewing thin fabrics, the stitching may become misaligned or the fabric may not feed correctly. If this occurs, place thin paper or stabilizer material under the fabric and sew it together with the fabric. When you have finished sewing, tear off any excess paper.

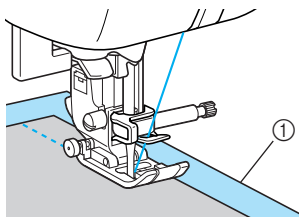

① Stabilizer material or paper

Sewing stretch fabrics

First, baste the pieces of fabric together, and then sew without stretching the fabric.

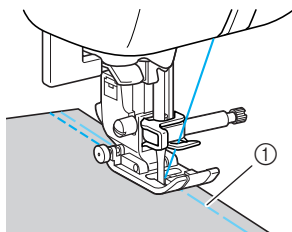

① Basting

For best results when sewing on knit fabrics use the stretch stitches recommended below. Also be sure to use a needle for knits.

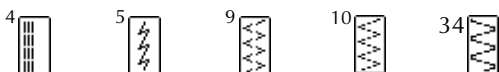

Sewing leathers or vinyl fabrics

When sewing the fabrics that may stick to the presser foot such as leathers or coated fabrics, change the presser foot to the non stick foot.

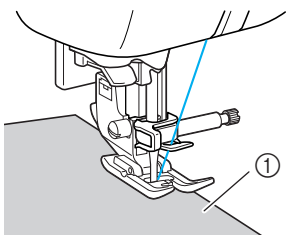

① Leather

Sewing an even seam allowance

To sew an even seam allowance, start sewing so that the seam allowance is to the right of the presser foot, and the edge of the fabric is aligned with either the right edge of the presser foot or a marking on the needle plate.

■ Aligning the fabric with the presser foot

Sew while keeping the right edge of the presser foot a fixed distance from the edge of the fabric.

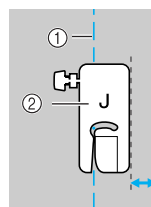

① Seam
② Presser foot

■ Aligning the fabric with the stitch guide foot

Sew while keeping the right edge of the fabric aligned with a desired position of markings on the stitch guide foot.

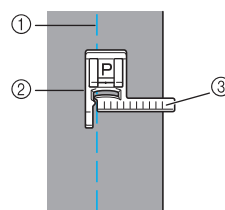

① Seam
② Stitch guide foot
③ Markings

■ Aligning the fabric with a needle plate marking

The markings on the needle plate show the distance from the needle position of a seam sewn with the straight stitch (left needle position). Sew while keeping the edge of the fabric aligned with a marking in the needle plate. The distance between the markings in the upper scale is 1/8 inch (3 mm) and the distance between the markings in the grid is 5 mm (3/16 inch).

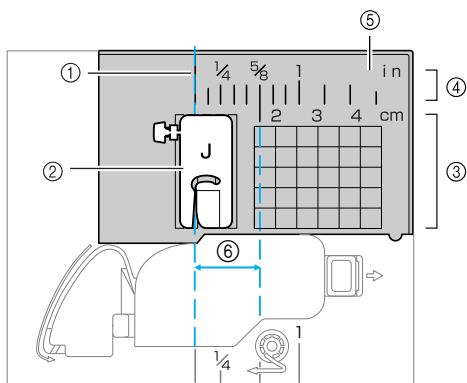

- ① Seam
- ② Presser foot
- ③ Centimeters
- ④ Inches
- ⑤ Needle plate
- ⑥ 1.6 cm (5/8 inch)

Hands-free raising and lowering of the presser foot

Using the knee lifter, you can raise and lower the presser foot with your knee, leaving both hands free to handle the fabric.



■ Installing the knee lifter

- ① Turn off the sewing machine.

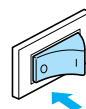

- ② Insert the knee lifter into the mounting slot on the front of the sewing machine in the lower-right corner.

Align the tabs on the knee lifter with the notches in the mounting slot, and then insert the knee lifter as far as possible.

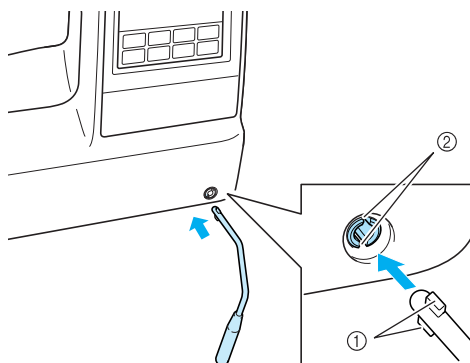

- ① Tabs
- ② Notches

⚡ Note

- If the knee lifter is not fully inserted into the mounting slot, it may fall out while the sewing machine is operating.

■ Using the knee lifter

- 1 **Stop the sewing machine.**
 - Do not use the knee lifter while the sewing machine is operating.
- 2 **With your knee, press the knee lifter to the right.**

Keep the knee lifter pressed to the right.

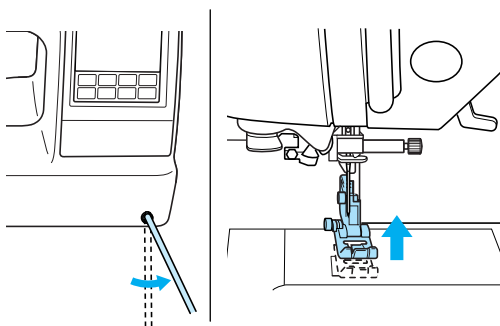

▶ The presser foot is raised.

- 3 **Release the knee lifter.**

▶ The presser foot is lowered.

! CAUTION

- While sewing, keep your knee away from the knee lifter. If the knee lifter is pressed while the sewing machine is operating, the needle may break or the machine may be damaged.

3

UTILITY STITCHES

















The various stitches and their applications are described in this chapter.





















Stitch Setting Chart	70	Appliqué, Patchwork and	
Utility stitches	70	Quilt Stitching	105
Other stitches.....	74	Appliqué stitching	106
Selecting Stitching	77	Patchwork (crazy quilt) stitching..	107
Stitch types.....	77	Piecing.....	107
Selecting stitching	77	Quilting.....	109
Saving stitch settings	79	Free-motion quilting.....	110
Overcasting Stitches.....	81	Satin stitching using the sewing	
Sewing overcasting stitches		speed controller	111
using overcasting foot “G”	81	Reinforcement Stitching	113
Sewing overcasting stitches		Triple stretch stitching.....	113
using zigzag foot “J”	82	Bar tack stitching.....	113
Sewing overcasting stitches		Darning	115
using the optional side cutter	83	Eyelet Stitching.....	117
Basic Stitching.....	85	Horizontal Stitching	118
Basting	85	Decorative Stitching.....	120
Basic stitching	85	Fagoting.....	121
Blind Hem Stitching	87	Scallop stitching	122
Buttonhole Stitching/Button Sewing....	89	Smocking.....	122
Buttonhole sewing.....	90	Shell tuck stitching	123
Button sewing	94	Joining.....	124
Zipper Insertion.....	96	Heirloom stitching.....	125
Inserting a centered zipper	96	Sewing the Various Built-in	
Inserting a side zipper	98	Decorative Patterns.....	128
Zipper/piping Insertion	101	Sewing beautiful patterns	128
Inserting a centered zipper	101	Sewing patterns.....	128
Inserting a piping	102	Changing the pattern size.....	129
Sewing Stretch Fabrics and		Changing the stitch density	129
Elastic Tape	103	Changing the length	
Stretch stitching	103	for satin stitches	130
Elastic attaching	103	Shifting patterns	131
		Combining patterns.....	132
		Saving patterns	135
		Realigning the pattern	136
		Designing a Pattern	
		(My Custom Stitch).....	139
		Drawing a sketch of the pattern ...	139
		Entering the pattern data.....	140
		Examples of designs.....	142



















Stitch Setting Chart

















Applications, stitch lengths and widths and whether the twin needle can be used are listed for utility stitches in the following table.

Utility stitches

Stitch Name	Pattern	Presser Foot	Application	Stitch Width [mm (inch)]		Stitch Length [mm (inch)]		Twin Needle	Reverse/Reinforcement Stitching	Walking Foot	
				Auto	Manual	Auto	Manual				
Straight stitch	Left		J	Basic stitching, sewing gathers or pintucks, etc.	0.0 (0)	0.0–7.0 (0–1/4)	2.5 (3/32)	0.2–5.0 (1/64–3/16)	Yes (J)	Reverse	No
			J	Basic stitching and sewing gathers or pintucks	0.0 (0)	0.0–7.0 (0–1/4)	2.5 (3/32)	0.2–5.0 (1/64–3/16)	Yes (J)	Reinforcement	Yes
	Center		J/I	Attaching zippers, basic stitching, sewing gathers or pintucks, etc.	3.5 (1/8)	0.0–7.0 (0–1/4)	2.5 (3/32)	0.2–5.0 (1/64–3/16)	Yes (J)	Reverse	No
Triple stretch stitch		J	Attaching sleeves, sewing inseams, sewing stretch fabrics and decorative stitching	0.0 (0)	0.0–7.0 (0–1/4)	2.5 (3/32)	1.5–4.0 (1/16–3/16)	Yes (J)	Reinforcement	No	
Stretch stitch		J	Sewing stretch fabrics and decorative stitching	1.0 (1/16)	1.0–3.0 (1/16–1/8)	2.5 (3/32)	1.0–4.0 (1/16–3/16)	Yes (J)	Reinforcement	No	
Basting stitch		J	Temporarily securing	0.0 (0)	0.0–7.0 (0–1/4)	20 (3/4)	5–30 (3/16–1-3/16)	No	Reinforcement	No	
Zigzag stitch	Center		J	Overcasting and attaching appliques	3.5 (1/8)	0.0–7.0 (0–1/4)	1.4 (1/16)	0.0–4.0 (0–3/16)	Yes (J)	Reverse	No
	Right		J	Beginning sewing from the right needle position	3.5 (1/8)	2.5–5.0 (3/32–3/16)	1.4 (1/16)	0.3–4.0 (1/64–3/16)	Yes (J)	Reinforcement	Yes
2-point zigzag stitch		J	Overcasting on medium weight or stretch fabrics, attaching elastic, darning, etc.	5.0 (3/16)	1.5–7.0 (1/16–1/4)	1.0 (1/16)	0.2–4.0 (1/64–3/16)	Yes (J)	Reinforcement	Yes	
3-point zigzag stitch		J	Overcasting on medium weight or stretch fabrics, attaching elastic, darning, etc.	5.0 (3/16)	1.5–7.0 (1/16–1/4)	1.0 (1/16)	0.2–4.0 (1/64–3/16)	Yes (J)	Reinforcement	No	
Overcasting stitch		G	Overcasting on thin or medium weight fabrics	3.5 (1/8)	2.5–5.0 (3/32–3/16)	2.0 (1/16)	1.0–4.0 (1/16–3/16)	No	Reinforcement	No	
		G	Overcasting on thick fabrics	5.0 (3/16)	2.5–5.0 (3/32–3/16)	2.5 (3/32)	1.0–4.0 (1/16–3/16)	No	Reinforcement	No	
		G	Preventing fraying in thick fabrics and fabrics that fray easily	5.0 (3/16)	3.5–5.0 (1/8–3/16)	2.5 (3/32)	1.0–4.0 (1/16–3/16)	No	Reinforcement	No	
		J	Overcasting on stretch fabrics	5.0 (3/16)	0.0–7.0 (0–1/4)	2.5 (3/32)	0.5–4.0 (1/32–3/16)	Yes (J)	Reinforcement	No	
		J	Overcasting on thick or stretch fabrics	5.0 (3/16)	0.0–7.0 (0–1/4)	2.5 (3/32)	0.5–4.0 (1/32–3/16)	Yes (J)	Reinforcement	No	
		J	Overcasting on stretch fabrics and decorative stitching	5.0 (3/16)	0.0–7.0 (0–1/4)	4.0 (3/16)	1.0–4.0 (1/16–3/16)	Yes (J)	Reinforcement	No	

Stitch Name	Pattern	Presser Foot	Application	Stitch Width [mm (inch)]		Stitch Length [mm (inch)]		Twin Needle	Reverse/Reinforcement Stitching	Walking Foot
				Auto	Manual	Auto	Manual			
Blind hem stitch		R	Blind hem stitching on medium weight fabrics	00 (0)	3← →3	2.0 (1/16)	1.0–3.5 (1/16–1/8)	No	Reinforcement	No
		R	Blind hem stitching on stretch fabrics	00 (0)	3← →3	2.0 (1/16)	1.0–3.5 (1/16–1/8)	No	Reinforcement	No
Appliqué stitch		J	Appliqué stitching	3.5 (1/8)	2.5–7.0 (3/32–1/4)	2.5 (3/32)	1.6–4.0 (1/16–3/16)	Yes (J)	Reinforcement	No
Shell tuck stitch		J	Shell tuck stitching	4.0 (3/16)	0.0–7.0 (0–1/4)	2.5 (3/32)	0.2–4.0 (1/64–3/16)	Yes (J)	Reinforcement	No
Piecing straight stitch		J	Piecing straight stitching (with a seam allowance of 6.5 mm (1/4 inch) from the right edge of the presser foot)	5.5 (7/32)	0.0–7.0 (0–1/4)	2.0 (1/16)	0.2–5.0 (1/64–3/16)	No	Reinforcement	No
		J	Piecing straight stitching (with a seam allowance of 6.5 mm (1/4 inch) from the left edge of the presser foot)	1.5 (1/16)	0.0–7.0 (0–1/4)	2.0 (1/16)	0.2–5.0 (1/64–3/16)	No	Reinforcement	Yes
Straight stitch that looks hand-sewn (for quilting)		J	Straight stitch quilting that looks hand-sewn	0.0 (0)	0.0–7.0 (0–1/4)	2.5 (3/32)	1.0–4.0 (1/16–3/16)	No	Reinforcement	No
Zigzag stitch (for quilting)		J	Appliqué quilting, free-motion quilting, satin stitching	3.5 (1/8)	0.0–7.0 (0–1/4)	1.4 (1/16)	0.0–4.0 (0–3/16)	No	Reinforcement	Yes
Appliqué stitch (for quilting)		J	Attaching appliques and binding	1.5 (1/16)	0.5–3.5 (1/32–1/8)	1.8 (1/16)	1.0–4.0 (1/16–3/16)	No	Reinforcement	No
Quilting stitch (for stippling)		J	Quilting background stitching (stippling)	7.0 (1/4)	1.0–7.0 (1/16–1/4)	1.6 (1/16)	1.0–4.0 (1/16–3/16)	No	Reinforcement	No
Satin scallop stitch		N	Scallop stitching	5.0 (3/16)	2.5–7.0 (3/32–1/4)	0.5 (1/32)	0.1–1.0 (1/64–1/16)	Yes (J)	Reinforcement	No
Joining stitch		J	Patchwork stitching and decorative stitching	4.0 (3/16)	0.0–7.0 (0–1/4)	1.2 (1/16)	0.2–4.0 (1/64–3/16)	Yes (J)	Reinforcement	No
		J	Patchwork stitching, decorative stitching and sewing overcasting on both pieces of fabric, such as with tricot	5.0 (3/16)	2.5–7.0 (3/32–1/4)	2.5 (3/32)	1.0–4.0 (1/16–3/16)	Yes (J)	Reinforcement	No
		J	Patchwork stitching and decorative stitching	5.0 (3/16)	0.0–7.0 (0–1/4)	1.2 (1/16)	0.2–4.0 (1/64–3/16)	Yes (J)	Reinforcement	No
Smocking stitch		J	Smocking stitching and decorative stitching	5.0 (3/16)	0.0–7.0 (0–1/4)	1.6 (1/16)	1.0–4.0 (1/16–3/16)	Yes (J)	Reinforcement	No
Fagoting stitch		J	Fagoting and decorative stitching	5.0 (3/16)	0.0–7.0 (0–1/4)	2.5 (3/32)	1.0–4.0 (1/16–3/16)	Yes (J)	Reinforcement	No
		J	Fagoting and decorative stitching	5.0 (3/16)	2.5–7.0 (3/32–1/4)	2.5 (3/32)	1.0–4.0 (1/16–3/16)	Yes (J)	Reinforcement	No
Elastic-attaching stitch		J	Attaching elastic to stretch fabrics	4.0 (3/16)	0.0–7.0 (0–1/4)	1.0 (1/16)	0.2–4.0 (1/64–3/16)	Yes (J)	Reinforcement	No
Ladder stitch		J	Decorative stitching	4.0 (3/16)	0.0–7.0 (0–1/4)	3.0 (1/8)	2.0–4.0 (1/16–3/16)	No	Reinforcement	No
Rick-rack stitch		J	Decorative stitching	4.0 (3/16)	0.0–7.0 (0–1/4)	2.5 (3/32)	1.0–4.0 (1/16–3/16)	Yes (J)	Reinforcement	No

Stitch Name	Pattern	Presser Foot	Application	Stitch Width [mm (inch)]		Stitch Length [mm (inch)]		Twin Needle	Reverse/Reinforcement Stitching	Walking Foot
				Auto	Manual	Auto	Manual			
Decorative stitch		J	Decorative stitching	5.5 (7/32)	0.0–7.0 (0–1/4)	1.6 (1/16)	1.0–4.0 (1/16–3/16)	Yes (J)	Reinforcement	No
Serpentine stitch		N	Decorative stitching and elastic-attaching	5.0 (3/16)	1.5–7.0 (1/16–1/4)	1.0 (1/16)	0.2–4.0 (1/64–3/16)	Yes (J)	Reinforcement	No
Hemstitching		N	Lace sewing, decorative hemming, heirloom stitching, etc.	3.5 (1/8)	1.5–7.0 (1/16–1/4)	2.5 (3/32)	1.6–4.0 (1/16–3/16)	No	Reinforcement	No
		N	Decorative hemming, heirloom stitching, etc.	6.0 (15/64)	1.5–7.0 (1/16–1/4)	3.0 (1/8)	1.5–4.0 (1/16–3/16)	No	Reinforcement	No
		N	Decorative hemming on thin, medium weight and plain weave fabrics, heirloom stitching, etc.	5.0 (3/16)	1.5–7.0 (1/16–1/4)	3.5 (1/8)	1.5–4.0 (1/16–3/16)	No	Reinforcement	No
		N	Decorative hemming on thin, medium weight and plain weave fabrics, heirloom stitching, etc.	5.0 (3/16)	1.5–7.0 (1/16–1/4)	4.0 (3/16)	1.5–4.0 (1/16–3/16)	Yes (J)	Reinforcement	No
		N	Decorative hemming on thin, medium weight and plain weave fabrics, heirloom stitching, etc.	5.0 (3/16)	1.5–7.0 (1/16–1/4)	2.5 (3/32)	1.5–4.0 (1/16–3/16)	Yes (J)	Reinforcement	No
		N	Decorative hemming on thin, medium weight and plain weave fabrics, heirloom stitching, etc.	5.0 (3/16)	1.5–7.0 (1/16–1/4)	2.0 (1/16)	1.5–4.0 (1/16–3/16)	Yes (J)	Reinforcement	No
		N	Decorative hemming, ribbon threading, heirloom stitching, etc.	5.0 (3/16)	1.5–7.0 (1/16–1/4)	3.0 (1/8)	1.5–4.0 (1/16–3/16)	Yes (J)	Reinforcement	No
		N	Decorative stitching, smocking stitching, heirloom stitching, etc.	6.0 (15/64)	1.5–7.0 (1/16–1/4)	1.6 (1/16)	1.0–4.0 (1/16–3/16)	No	Reinforcement	No
		N	Decorative stitching, smocking stitching, heirloom stitching, etc.	5.0 (3/16)	1.5–7.0 (1/16–1/4)	1.6 (1/16)	1.0–4.0 (1/16–3/16)	No	Reinforcement	No
Buttonhole stitch		A	Horizontal buttonholes on thin and medium weight fabrics	5.0 (3/16)	3.0–5.0 (1/8–3/16)	0.4 (1/64)	0.2–1.0 (1/64–1/16)	No	Automatic reinforcement	No
		A	Horizontal buttonholes on areas that are subject to strain	5.0 (3/16)	3.0–5.0 (1/8–3/16)	0.4 (1/64)	0.2–1.0 (1/64–1/16)	No	Automatic reinforcement	No
		A	Horizontal buttonholes on thick fabrics	5.0 (3/16)	3.0–5.0 (1/8–3/16)	0.4 (1/64)	0.2–1.0 (1/64–1/16)	No	Automatic reinforcement	No
		A	Secured buttonholes for fabrics that have backings	5.0 (3/16)	3.0–5.0 (1/8–3/16)	0.4 (1/64)	0.2–1.0 (1/64–1/16)	No	Automatic reinforcement	No
		A	Buttonholes for stretch or knit fabrics	6.0 (15/64)	3.0–6.0 (1/8–15/64)	1.0 (1/16)	0.5–2.0 (1/32–1/16)	No	Automatic reinforcement	No
		A	Buttonholes for stretch fabrics	6.0 (15/64)	3.0–6.0 (1/8–15/64)	1.5 (1/16)	1.0–3.0 (1/16–1/8)	No	Automatic reinforcement	No
		A	Bound buttonholes	5.0 (3/16)	0.0–6.0 (0–15/64)	2.0 (1/16)	0.2–4.0 (1/64–3/16)	No	Automatic reinforcement	No

Stitch Name	Pattern	Presser Foot	Application	Stitch Width [mm (inch)]		Stitch Length [mm (inch)]		Twin Needle	Reverse/Reinforcement Stitching	Walking Foot
				Auto	Manual	Auto	Manual			
Buttonhole stitch		A	Keyhole buttonholes for thick or furry fabrics	7.0 (1/4)	3.0–7.0 (1/8–1/4)	0.5 (1/32)	0.3–1.0 (1/64–1/16)	No	Automatic reinforcement	No
		A	Keyhole buttonholes for medium weight and thick fabrics	7.0 (1/4)	3.0–7.0 (1/8–1/4)	0.5 (1/32)	0.3–1.0 (1/64–1/16)	No	Automatic reinforcement	No
		A	Horizontal buttonholes for thick or furry fabrics	7.0 (1/4)	3.0–7.0 (1/8–1/4)	0.5 (1/32)	0.3–1.0 (1/64–1/16)	No	Automatic reinforcement	No
Darning stitch		A	Darning medium weight fabrics	7.0 (1/4)	2.5–7.0 (3/32–1/4)	2.0 (1/16)	0.4–2.5 (1/64–3/32)	No	Automatic reinforcement	No
		A	Darning thick fabrics	7.0 (1/4)	2.5–7.0 (3/32–1/4)	2.0 (1/16)	0.4–2.5 (1/64–3/32)	No	Automatic reinforcement	No
Bar tack stitch		A	Reinforcing openings and areas where the seam easily comes loose	2.0 (1/16)	1.0–3.0 (1/16–1/8)	0.4 (1/64)	0.3–1.0 (1/64–1/16)	No	Automatic reinforcement	No
Button-sewing stitch		M	Button sewing	3.5 (1/8)	2.5–4.5 (3/32–3/16)	–	–	No	Automatic reinforcement	No
Eyelet stitch		N	Sewing eyelets, for example, on belts	7.0 (1/4)	7.0, 6.0, 5.0 (1/4, 15/64, 3/16)	7.0 (1/4)	7.0, 6.0, 5.0 (1/4, 15/64, 3/16)	No	Automatic reinforcement	No
Side cutter		S	Sewing straight stitches while cutting the fabric	0.0 (0)	0.0–2.5 (0–3/32)	2.5 (3/32)	0.2–5.0 (1/64–3/16)	No	Reinforcement	No
		S	Sewing zigzag stitches while cutting the fabric	3.5 (1/8)	3.5–5.0 (1/8–3/16)	1.4 (1/16)	0.0–4.0 (0–3/16)	No	Reinforcement	No
		S	Overcasting on thin and medium weight fabrics while cutting the fabric	3.5 (1/8)	3.5–5.0 (1/8–3/16)	2.0 (1/16)	1.0–4.0 (1/16–3/16)	No	Reinforcement	No
		S	Overcasting on thick fabrics while cutting the fabric	5.0 (3/16)	3.5–5.0 (1/8–3/16)	2.5 (3/32)	1.0–4.0 (1/16–3/16)	No	Reinforcement	No
		S	Overcasting on medium weight and thick fabrics while cutting the fabric	5.0 (3/16)	3.5–5.0 (1/8–3/16)	2.5 (3/32)	1.0–4.0 (1/16–3/16)	No	Reinforcement	No
Horizontal straight stitch		N	Attaching appliqués to sleeves (straight stitch sewn to the left)	–	–	–	–	No	Reinforcement	No
		N	Attaching appliqués to sleeves (straight stitch sewn to the right)	–	–	–	–	No	Reinforcement	No
Horizontal zigzag stitch		N	Attaching appliqués to sleeves (zigzag stitch sewn to the left)	–	–	–	–	No	Reinforcement	No
		N	Attaching appliqués to sleeves (zigzag stitch sewn to the right)	–	–	–	–	No	Reinforcement	No

Other stitches

Stitch Type	Pattern										Presser Foot	Twin Needle	Pattern Size	Adjustable Stitching Density	Adjustable Pattern Length/width	Left/Right Flipping
Decorative stitches	1	2	3	4	5	6	7	8	9	10	N	No	Large, Small	No	Large: No Small: Yes (*Not possible)	Yes
	11	12	13	14	15	16	17	18	19	20						
	21	22	23	24	25	26	27	28	29*	30*						
	31**															
Satin stitches	1	2	3	4	5	6	7	8	9	10	N	Yes (*Not possible)	Large	No	Yes (*Not possible)	Yes (*Not possible)
	11	12	13	14	15	16	17*	18*								
Cross-stitches	1	2	3	4	5	6*	7*	8*	9*	10*	N	No	Large	No	Yes (*Not possible)	Yes
	11*	12*	13*	14*	15*											
Decorative satin stitches	1	2	3	4	5	6	7	8	9	10	N	No	Large, Small	Yes	Yes (length only)	Yes
Combined utility stitches	1	2	3	4	5	6	7	8	9	10	N	No	Large	No	Yes	Yes
	11	12	13	14	15	16	17	18	19	20						
	21	22	23	24	25	26	27	28	29	30						
	31	32	33	34	35	36	37	38	39							

** Pattern for making adjustment

Stitch Type	Pattern										Presser Foot	Twin Needle	Pattern Size	Adjustable Stitching Density	Adjustable Pattern Length/width	Left/Right Flipping
	1	2	3	4	5	6	7	8	9	10						
Character stitches (Gothic font)	A	B	C	D	E	F	G	H	I	J	N	No	Large, Small	No	No	Yes
	11	12	13	14	15	16	17	18	19	20						
	K	L	M	N	O	P	Q	R	S	T						
	21	22	23	24	25	26	27	28	29	30						
	U	V	W	X	Y	Z	0	1	2	3						
	31	32	33	34	35	36	37	38	39	40						
	4	5	6	7	8	9	&	?	!	—						
	41	42	43	44	45	46	47	48	49	50						
	—	()	'	.	,	Ä	Å	Æ	Ñ						
	51	52	53	54	55	56	57	58	59	60						
Ö	Ø	Ç	Ü	ß	α	β	γ	δ	ε							
61	62	63	64	65	66	67	68	69	70							
f	g	h	i	j	k	l	m	n	o							
71	72	73	74	75	76	77	78	79	80							
p	q	r	s	t	u	v	w	x	y							
81	82	83	84	85	86	87	88	89	90							
z	ä	å	æ	ë	è	é	ê	ë	ñ							
91	92	93	94	95	96	97										
ö	ò	ø	ï	ç	ü	ù										
Character stitches (Script font)	A	B	C	D	E	F	G	H	I	J	N	No	Large	No	No	Yes
	11	12	13	14	15	16	17	18	19	20						
	K	L	M	N	O	P	Q	R	S	T						
	21	22	23	24	25	26	27	28	29	30						
	U	V	W	X	Y	Z	0	1	2	3						
	31	32	33	34	35	36	37	38	39	40						
	4	5	6	7	8	9	&	?	!	—						
	41	42	43	44	45	46	47	48	49	50						
	—	()	'	.	,	À	Á	Â	Ã						
	51	52	53	54	55	56	57	58	59	60						
Ö	Ø	Ç	Ü	ß	a	b	c	d	e							
61	62	63	64	65	66	67	68	69	70							
f	g	h	i	j	k	l	m	n	o							
71	72	73	74	75	76	77	78	79	80							
p	q	r	s	t	u	v	w	x	y							
81	82	83	84	85	86	87	88	89	90							
z	ä	å	æ	ë	è	é	ê	ë	ñ							
91	92	93	94	95	96	97										
ö	ò	ø	ï	ç	ü	ù										

Stitch Type	Pattern										Presser Foot	Twin Needle	Pattern Size	Adjustable Stitching Density	Adjustable Pattern Length/width	Left/Right Flipping
Character stitches (Outline style)	1	2	3	4	5	6	7	8	9	10	N	No	Large, Small	No	No	Yes
	A	B	C	D	E	F	G	H	I	J						
	11	12	13	14	15	16	17	18	19	20						
	K	L	M	N	O	P	Q	R	S	T						
	21	22	23	24	25	26	27	28	29	30						
	U	V	W	X	Y	Z	0	1	2	3						
	31	32	33	34	35	36	37	38	39	40						
	4	5	6	7	8	9	&	?	!	-						
	41	42	43	44	45	46	47	48	49	50						
	_	()	'	.	,	Ä	À	Æ	Ñ						
51	52	53	54	55	56	57	58	59	60							
ö	ø	ç	ù	ß	a	b	c	d	e							
61	62	63	64	65	66	67	68	69	70							
f	g	h	i	j	k	l	m	n	o							
71	72	73	74	75	76	77	78	79	80							
P	q	r	s	t	u	v	w	x	y							
81	82	83	84	85	86	87	88	89	90							
z	ä	à	á	æ	ë	è	é	ê	ñ							
91	92	93	94	95	96	97										
ü	ò	ø	ì	ç	ù	ù										

Selecting Stitching

This section provides details on the various types of stitches available and the procedure for selecting a stitch.

Stitch types

A stitch can be selected from the following types available.

For details on the various stitches, refer to “Stitch Setting Chart” (page 70).

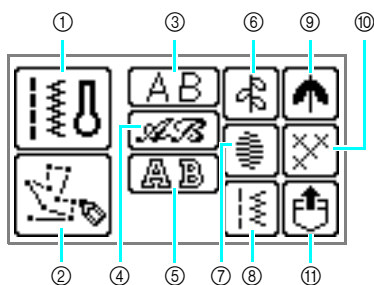



- ① **Utility stitches** 

You can select from 71 utility stitches, including straight line stitching, overcasting, button holes and basic decorative stitches. If this is selected, the utility stitch selection appears right after the power is turned on.
- ② **My Custom Stitch** 

You can design original stitches. (For details, refer to “Designing a Pattern (My Custom Stitch)” (page 139).)
- ③ **Character stitches—Gothic font** 

(Can be combined)
There are 97 characters, including letters, symbols and numbers, in the Gothic font.
- ④ **Character stitches—Script font** 

(Can be combined)
There are 97 characters, including letters, symbols and numbers, in the Script font.
- ⑤ **Character stitches—Outline style** 

(Can be combined)
There are 97 characters, including letters, symbols and numbers, in the outline style.
- ⑥ **Decorative stitches** 

(Can be combined)
You can select from 31 decorative stitches, including leaves, flowers and hearts. You can sew combinations of multiple decorative stitches.
- ⑦ **Satin stitches** 

(Can be combined)
You can select from 18 satin stitches. You can sew combinations of multiple decorative stitches.

- ⑧ **Combined utility stitches** 

(Can be combined)
You can sew with combinations from 39 utility stitches.
- ⑨ **Decorative satin stitches** 

(Can be combined)
There are 10 decorative satin stitches.
- ⑩ **Cross stitches** 

(Can be combined)
You can select from 15 cross stitches. You can sew combinations of multiple decorative stitches.
- ⑪ **Patterns saved in the machine's memory** 

You can retrieve a saved pattern. (For details, refer to “Saving patterns” (page 135).)

Selecting stitching

- 1 Turn on the sewing machine.

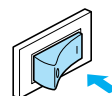

- When an animation is displayed on the screen, touch the screen with your finger.
- ▶ The straight stitch (left needle position) is shown selected on the screen.

- 2 Press  (Utility stitch key) on the operation panel.

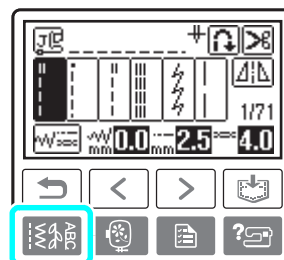

- ▶ The screen containing the various types of stitches appears.

3 Select the stitch type.

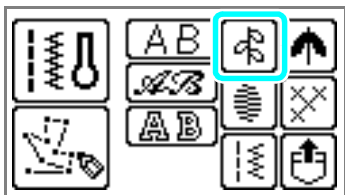

- When a decorative stitch is selected



▶ The screen containing the various stitches in the selected stitch type appears.

- To select a different stitch type, press  (Back key).

4 Press the stitch selection.

 (Previous page key) displays the previous screen, and  (Next page key) displays the next screen.

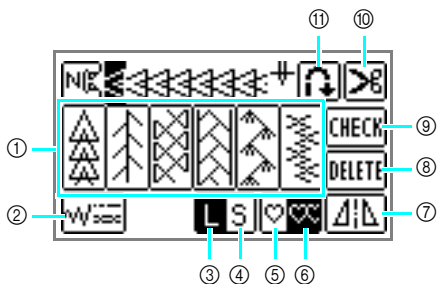
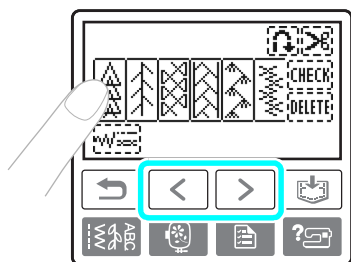

- ① Decorative stitch selection
- ② Set width, length and tension
- ③ Large pattern size
- ④ Small pattern size
- ⑤ Single stitch sewing
- ⑥ Repeat sewing
- ⑦ Horizontal mirror image
- ⑧ Delete a selected pattern
- ⑨ Check combined pattern
- ⑩ Automatic thread cutting
- ⑪ Automatic reverse/reinforcement stitch

- To select a different stitch, press  to remove the selected pattern.

5 If necessary, specify the setting for automatic reverse/reinforcement stitching and adjust the stitch length, etc.

- For details on sewing with each of the utility stitches, begin on page 81.

Note

- When a stitch is selected, the icon for the presser foot that should be used appears on the screen. Check that the correct presser foot is attached before starting to sew. If the wrong presser foot is installed, turn off the sewing machine, attach the correct presser foot, and then select the desired stitch again.

Memo

- For details on adjusting the stitch width and length, refer to “Adjusting the stitch width” (page 58) and “Adjusting the stitch length” (page 59).

■ Selecting characters

Three styles of character stitches are available. The procedure for selecting a character is the same with all styles.

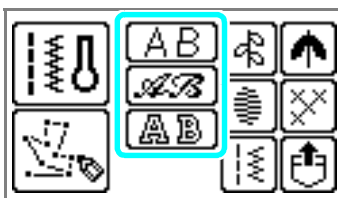

1 Follow steps 1 and 2 in “Selecting stitching” (page 77) to display the screen where a stitch type can be selected.

2 Select the character style.



3 Select the characters.



- If a wrong character was selected, press  to erase the character, and then select the correct character.
- To select a different character style, press , and then select the new character style.
- Press  to view a sample of the selected pattern.
- To enter a space, press “_”.

□ Example: Bus

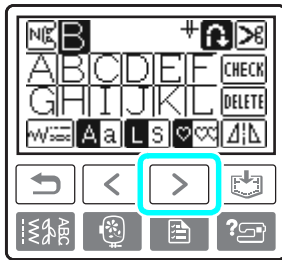
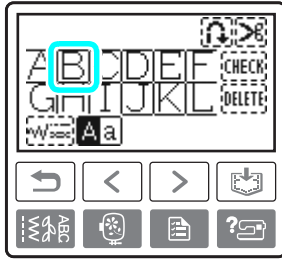

Saving stitch settings

This machine is preset with the default settings for the stitch width (zigzag width), stitch length, thread tension, programmed thread cutting, and automatic reverse/reinforcement stitching for each stitch. However, if you wish to save specific settings for a stitch so that they can be used later, press **MEM-ORY** after changing the settings to save the new settings with the selected stitch.

This feature can be used only with utility stitches.

- To use a stitch length of 2.0 mm for the straight stitch

- 1 Select a straight stitch.
- 2 Press **MEM-ORY**.

Memo

- The default stitch length is 2.5 mm.

- 3 Set the stitch length to 2.0 mm.

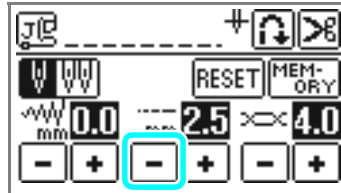

- 4 Press **MEM-ORY**.

- To reset the selected stitch pattern to its default settings, press **RESET**, and then press **MEM-ORY**.

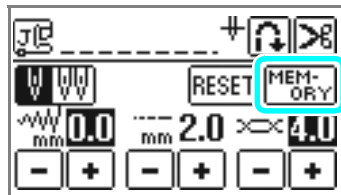

- ▶ The confirmation message is displayed.

5 Press **OK**.

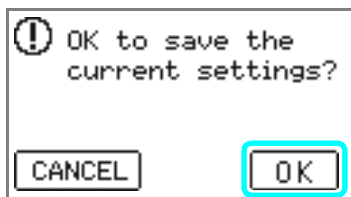

Note

- The next time that the same straight stitch is selected, the stitch length is set to 2.0 mm.
- All stitch settings (stitch width (zigzag width), stitch length, thread tension, programmed thread cutting, and automatic reverse/reinforcement stitching, etc.) are saved, not just the setting that was changed. When the same stitch pattern is selected, the last settings saved are displayed even if the machine was turned off. If the settings are changed again, or if **RESET** is pressed to reset the setting to its default, the new settings are not saved unless **MEM-ORY** is pressed another time.



Even if **RESET** is pressed, the settings for programmed thread cutting and automatic reverse/reinforcement stitching cannot be reset.

Overcasting Stitches

Sew overcasting stitches along the edges of cut fabric to prevent fabric from fraying. 15 stitches are available for overcasting. The procedure for sewing overcasting stitch is explained according to the presser foot that is used.

Sewing overcasting stitches using overcasting foot “G”

Three stitches can be used to sew overcasting with overcasting foot “G”.

Stitch Name	Pattern	Application	Stitch Width [mm (inch)]		Stitch Length [mm (inch)]		Presser Foot
			Auto	Manual	Auto	Manual	
Overcasting stitch	11 	Preventing fraying in medium weight and thin fabrics	3.5 (1/8)	2.5–5.0 (3/32–3/16)	2.0 (1/16)	1.0–4.0 (1/16–3/16)	G
	12 	Preventing fraying in thick fabrics and fabrics that fray easily	5.0 (3/16)	2.5–5.0 (3/32–3/16)	2.5 (3/32)	1.0–4.0 (1/16–3/16)	
	13 		5.0 (3/16)	3.5–5.0 (1/8–3/16)	2.5 (3/32)	1.0–4.0 (1/16–3/16)	

1 Attach overcasting foot “G”.

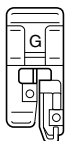

- For details, refer to “Replacing the presser foot” (page 44).

2 Select a stitch.

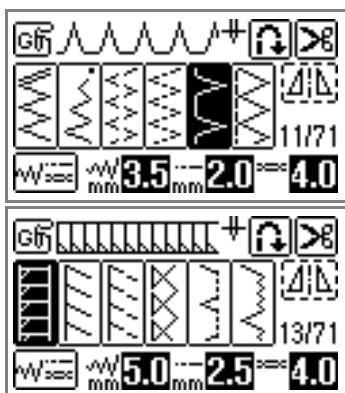

- For details, refer to “Selecting stitching” (page 51).

3 Position the fabric with the edge of the fabric against the guide of the presser foot, and then lower the presser foot lever.

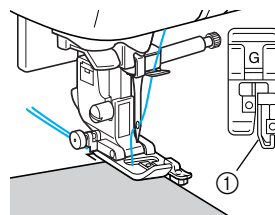

- ① Guide

4 Sew with the edge of the fabric against the presser foot guide.

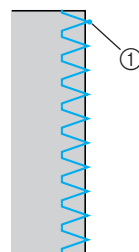

- ① Needle drop point

Sewing overcasting stitches using zigzag foot “J”

Seven stitches can be used to sew overcasting stitches with zigzag foot “J”.

Stitch Name	Pattern	Application	Stitch Width [mm (inch)]		Stitch Length [mm (inch)]		Presser Foot
			Auto	Manual	Auto	Manual	
Zigzag stitch (center needle position)		Preventing fraying (center baseline/reverse stitching)	3.5 (1/8)	0.0–7.0 (0–1/4)	1.4 (1/16)	0.0–4.0 (0–3/16)	J
Zigzag stitch (right needle position)		Preventing fraying (right baseline/reinforcement stitching)	3.5 (1/8)	2.5–5.0 (3/32–3/16)	1.4 (1/16)	0.3–4.0 (1/64–3/16)	
2-point zigzag stitch		Preventing fraying in thick fabrics and stretch fabrics	5.0 (3/16)	1.5–7.0 (1/16–1/4)	1.0 (1/16)	0.2–4.0 (1/64–3/16)	
3-point zigzag stitch			5.0 (3/16)	1.5–7.0 (1/16–1/4)	1.0 (1/16)	0.2–4.0 (1/64–3/16)	
Overcasting stitch		Preventing fraying in stretch fabrics	5.0 (3/16)	0.0–7.0 (0–1/4)	2.5 (3/32)	0.5–4.0 (1/32–3/16)	
		Preventing fraying in thick fabrics and stretch fabrics	5.0 (3/16)	0.0–7.0 (0–1/4)	2.5 (3/32)	0.5–4.0 (1/32–3/16)	
		Preventing fraying in stretch fabrics	4.0 (3/16)	0.0–7.0 (0–1/4)	4.0 (3/16)	1.0–4.0 (1/16–3/16)	

1 Attach zigzag foot “J”.

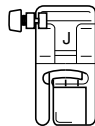

- For details, refer to “Replacing the presser foot” (page 44).

2 Select a stitch.

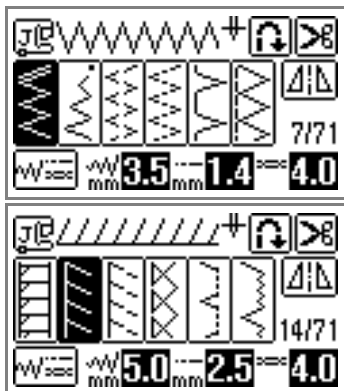

- For details, refer to “Selecting stitching” (page 51).

3 Sew along the edge of the fabric with the needle dropping off the edge at the right.

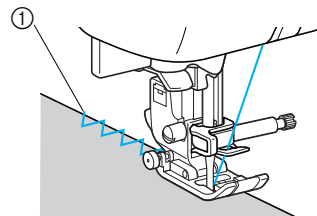

① Needle drop point

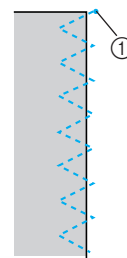

① Needle drop point





Sewing overcasting stitches using the optional side cutter

Using the side cutter, seam allowances can be finished while the edge of the fabric is cut off. Five stitches can be used to sew overcasting stitches with the side cutter.



Note

- Thread the needle manually when using the side cutter, or only attach the side cutter after threading the needle using the needle threader.

Stitch Name	Pattern	Application	Stitch Width [mm (inch)]		Stitch Length [mm (inch)]		Presser Foot
			Auto	Manual	Auto	Manual	
Side Cutter	63 	Sewing straight stitches while cutting the fabric	0.0 (0)	0.0–2.5 (0–3/32)	2.5 (3/32)	0.2–5.0 (1/64–3/16)	S
	64 	Sewing zigzag stitches while cutting the fabric	3.5 (1/8)	3.5–5.0 (1/8–3/16)	1.4 (1/16)	0.0–4.0 (0–3/16)	
	65 	Preventing fraying in thin and medium weight fabrics while cutting the fabric	3.5 (1/8)	3.5–5.0 (1/8–3/16)	2.0 (1/16)	1.0–4.0 (1/16–3/16)	
	66 	Preventing fraying in thick fabrics while cutting the fabric	5.0 (3/16)	3.5–5.0 (1/8–3/16)	2.5 (3/32)	1.0–4.0 (1/16–3/16)	
	67 	Preventing fraying in thick fabrics while cutting the fabric	5.0 (3/16)	3.5–5.0 (1/8–3/16)	2.5 (3/32)	1.0–4.0 (1/16–3/16)	

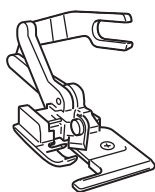

1 Remove the presser foot.

- For details, refer to “Replacing the presser foot” (page 44).

2 Hook the connecting fork of the side cutter onto the needle clamp screw.

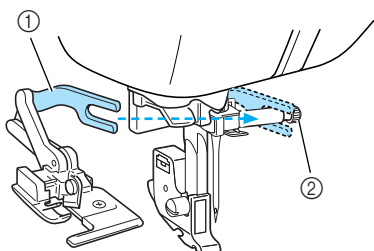

- ① Connecting fork
- ② Needle clamp screw

3 Position the side cutter so that side cutter pin is aligned with the notch in the presser foot holder, and then slowly lower the presser foot lever.

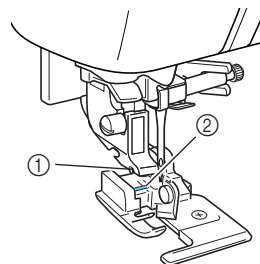

- ① Notch in presser foot holder
- ② Pin

▶ The side cutter is attached.

4 Raise the presser foot lever to check that the side cutter is securely attached.

5 Pass the upper thread under the side cutter, and then pull it out toward the rear of the sewing machine.

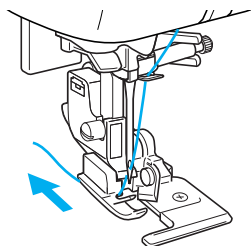

6 Select a stitch.

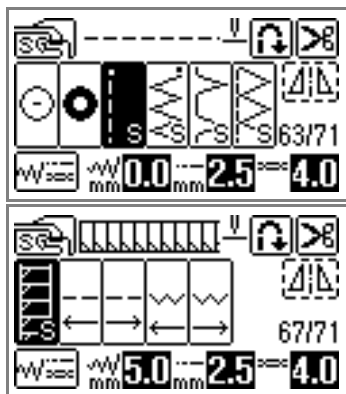

• For details, refer to “Selecting stitching” (page 51).

7 Make a cut of about 2 cm (3/4 inch) long in the fabric at the beginning of the stitching.

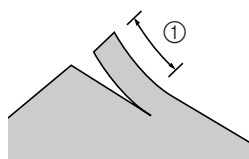

① 2 cm (3/4 inch)

8 Position the fabric in the side cutter.

The cut in the fabric should be positioned over the guide plate of the side cutter.

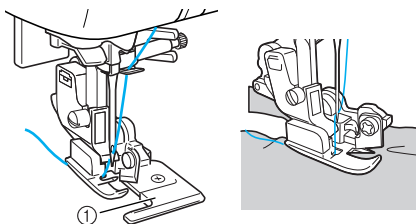

① Guide plate

• If the fabric is not positioned correctly, the fabric will not be cut.

9 Lower the presser foot lever, and then start sewing.

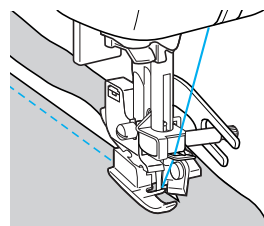

▶ A seam allowance is cut while the stitching is sewn.

• If the stitching is sewn in a straight line ⁶³, the seam allowance will be about 5 mm (3/16 inch).

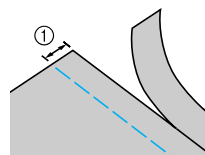





① 5 mm (3/16 inch)

Memo

- The side cutter can cut as much as one layer of 13-oz. denim.
- After using the side cutter, clean it by removing any lint or dust.
- If the side cutter can no longer cut fabric, use a rag to apply a small amount of oil to the cutting edge of the cutter.

Basic Stitching

Straight stitches are used for sewing plain seams. Five stitches are available for basic stitching.

Stitch Name	Pattern	Application	Stitch Width [mm (inch)]		Stitch Length [mm (inch)]		Presser Foot
			Auto	Manual	Auto	Manual	
Basting stitch		Temporarily securing	0.0 (0)	0.0–7.0 (0–1/4)	20 (3/4)	5–30 (3/16–1-3/16)	J
Straight stitch (left needle position)		Basic stitching and sewing gathers or pintucks (left baseline/reverse stitching)	0.0 (0)	0.0–7.0 (0–1/4)	2.5 (3/32)	0.2–5.0 (1/64–3/16)	
		Basic stitching and sewing gathers or pintucks (left baseline/reinforcement stitching)	0.0 (0)	0.0–7.0 (0–1/4)	2.5 (3/32)	0.2–5.0 (1/64–3/16)	
Straight stitch (center needle position)		Basic stitching and sewing gathers or pintucks (center baseline/reverse stitching)	3.5 (1/8)	0.0–7.0 (0–1/4)	2.5 (3/32)	0.2–5.0 (1/64–3/16)	
Triple stretch stitch		Reinforcing seams and sewing stretch fabrics	0.0 (0)	0.0–7.0 (0–1/4)	2.5 (3/32)	1.5–4.0 (1/16–3/16)	

Basting

Sew basting with a stitch length between 5 mm (3/16 inch) and 30 mm (1-3/16 inches).

1 Attach zigzag foot “J”.

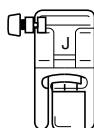

- For details, refer to “Replacing the presser foot” (page 44).

2 Select stitch .

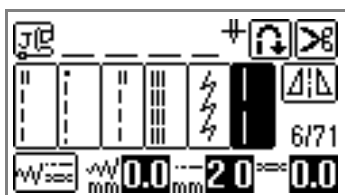

- For details, refer to “Selecting stitching” (page 51).

3 Start sewing.

- For details, refer to “Starting to sew” (page 53).

Basic stitching

1 Baste or pin together the fabric pieces.

2 Attach zigzag foot “J”.

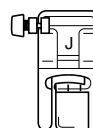

- For details, refer to “Replacing the presser foot” (page 44).

3 Select a stitch.

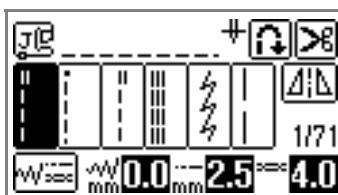

- For details, refer to “Selecting stitching” (page 51).

4 Lower the needle into the fabric at the beginning of the stitching.

5 Lower the presser foot lever, and then start sewing.

- For details, refer to “Starting to sew” (page 53).
- For details on sewing reverse/reinforcement stitches, refer to “Securing the stitching” (page 55).

6 When sewing is finished, cut the thread.

- For details, refer to “Cutting the thread” (page 56).



Changing the needle position

The needle position used as the baseline is different for the straight stitch (left needle position) and the straight stitch (center needle position).

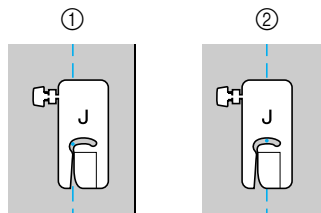

- ① Straight stitch (left needle position)
- ② Straight stitch (center needle position)

When the stitch width of the straight stitch (left needle position) is set to its standard setting (0.0 mm), the distance from the needle position to the right side of the presser foot is 12 mm (1/2 inch). If the stitch width is changed (between 0 and 7.0 mm (1/4 inch)), the needle position will also change. By changing the stitch width and sewing with the right side of the presser foot aligned with the edge of the fabric, a seam allowance can be sewn with a fixed width.

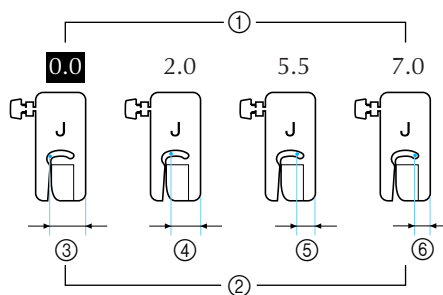

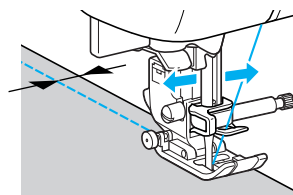

- ① Stitch width setting
- ② Distance from the needle position to the right side of the presser foot
- ③ 12.0 mm (1/2 inch)
- ④ 10.0 mm (3/8 inch)
- ⑤ 6.5 mm (1/4 inch)
- ⑥ 5.0 mm (3/16 inch)



- For details, refer to “Adjusting the stitch width” (page 58).

Blind Hem Stitching

Secure the bottoms of skirts and pants with a blind hem. Two stitches are available for blind hem stitching.

Stitch Name	Pattern	Application	Stitch Width [mm (inch)]		Stitch Length [mm (inch)]		Presser Foot
			Auto	Manual	Auto	Manual	
Blind hem stitch	17 	Blind hem stitching on medium weight fabrics	00 (0)	3← -- →3	2.0 (1/16)	1.0–3.5 (1/16–1/8)	R
	18 	Blind hem stitching on stretch fabrics	00 (0)	3← -- →3	2.0 (1/16)	1.0–3.5 (1/16–1/8)	

Sew a blind hem according to the following procedure.

- 1 Fold the fabric along the desired edge of the hem, and then baste it about 5 mm (3/16 inch) from the edge of the fabric.

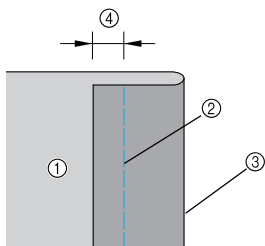

- ① Wrong side of fabric
- ② Basting stitching
- ③ Desired edge of hem
- ④ 5 mm (3/16 inch)

- 2 Fold back the fabric along the basting, and then position the fabric with the wrong side facing up.

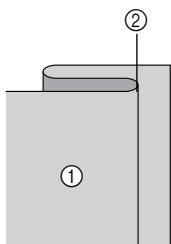

- ① Wrong side of fabric
- ② Basting

- 3 Attach blind hem foot "R".

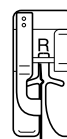

- For details, refer to "Replacing the presser foot" (page 44).

- 4 Select a stitch.

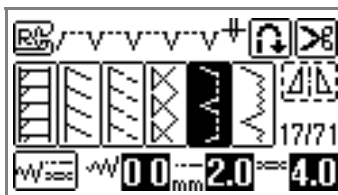

- For details, refer to "Selecting stitching" (page 51).

- 5 Position the fabric with the edge of the folded hem against the guide of the presser foot, and then lower the presser foot lever.

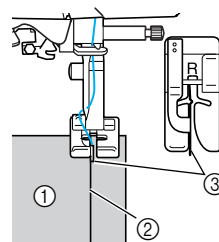

- ① Wrong side of fabric
- ② Fold of hem
- ③ Guide

6 Adjust the stitch width until the needle slightly catches the fold of the hem.

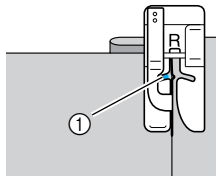

① Needle drop point

When you change the needle drop point, raise the needle, and then change the stitch width.

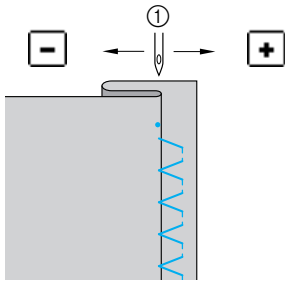

① Stitch width

■ If the needle catches too much of the hem fold

The needle is too far to the left.

Press **+** to decrease the stitch width so that the needle slightly catches the fold of the hem.

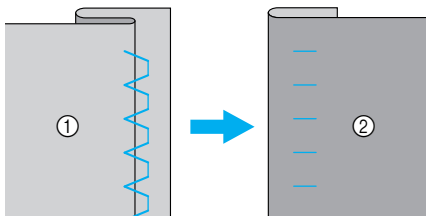

① Wrong side of fabric
② Right side of fabric

■ If the needle does not catch the hem fold

The needle is too far to the right.

Press **-** to increase the stitch width so that the needle slightly catches the fold of the hem.

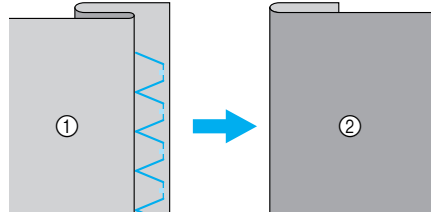

① Wrong side of fabric
② Right side of fabric

• For details, refer to “Adjusting the stitch width” (page 58).

7 Sew with the fold of the hem against the presser foot guide.



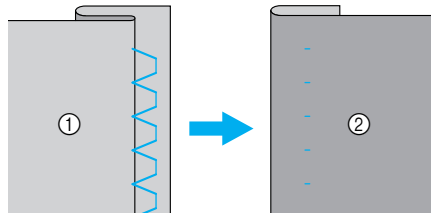







8 Remove the basting stitching.



① Wrong side of fabric
② Right side of fabric

Buttonhole Stitching/Button Sewing

Buttonholes can be sewn and buttons can be sewn on. 10 stitches are available for sewing one-step buttonholes and one stitch for sewing on buttons.

Stitch Name	Pattern	Application	Stitch Width [mm (inch)]		Stitch Length [mm (inch)]		Presser Foot
			Auto	Manual	Auto	Manual	
Buttonhole stitch	48 	Horizontal buttonholes on thin and medium weight fabrics	5.0 (3/16)	3.0–5.0 (1/8–3/16)	0.4 (1/64)	0.2–1.0 (1/64–1/16)	A
	49 	Horizontal buttonholes on areas that are subject to strain	5.0 (3/16)	3.0–5.0 (1/8–3/16)	0.4 (1/64)	0.2–1.0 (1/64–1/16)	
	50 	Horizontal buttonholes on thick fabrics	5.0 (3/16)	3.0–5.0 (1/8–3/16)	0.4 (1/64)	0.2–1.0 (1/64–1/16)	
	51 	Buttonholes with bar tacks on both ends for stabilized fabrics	5.0 (3/16)	3.0–5.0 (1/8–3/16)	0.4 (1/64)	0.2–1.0 (1/64–1/16)	
	52 	Buttonholes for stretch or knit fabrics	6.0 (15/64)	3.0–6.0 (1/8–15/64)	1.0 (1/16)	0.5–2.0 (1/32–1/16)	
	53 	Buttonholes for stretch fabrics	6.0 (15/64)	3.0–6.0 (1/8–15/64)	1.5 (1/16)	1.0–3.0 (1/16–1/8)	
	54 	Bound buttonholes	5.0 (3/16)	0.0–6.0 (0–15/64)	2.0 (1/16)	0.2–4.0 (1/64–3/16)	
	55 	Keyhole buttonholes for thick or plush fabrics	7.0 (1/4)	3.0–7.0 (1/8–1/4)	0.5 (1/32)	0.3–1.0 (1/64–1/16)	
	56 	Keyhole buttonholes for medium weight and thick fabrics	7.0 (1/4)	3.0–7.0 (1/8–1/4)	0.5 (1/32)	0.3–1.0 (1/64–1/16)	
	57 	Horizontal buttonhole for thick or plush fabrics	7.0 (1/4)	3.0–7.0 (1/8–1/4)	0.5 (1/32)	0.3–1.0 (1/64–1/16)	
Button-sewing stitch	61 	Button sewing	3.5 (1/8)	2.5–4.5 (3/32–3/16)	–	–	M

Buttonhole sewing

The maximum buttonhole length is about 28 mm (1-1/8 inches) (diameter + thickness of the button). Buttonholes are sewn from the front of the presser foot to the back, as shown below.

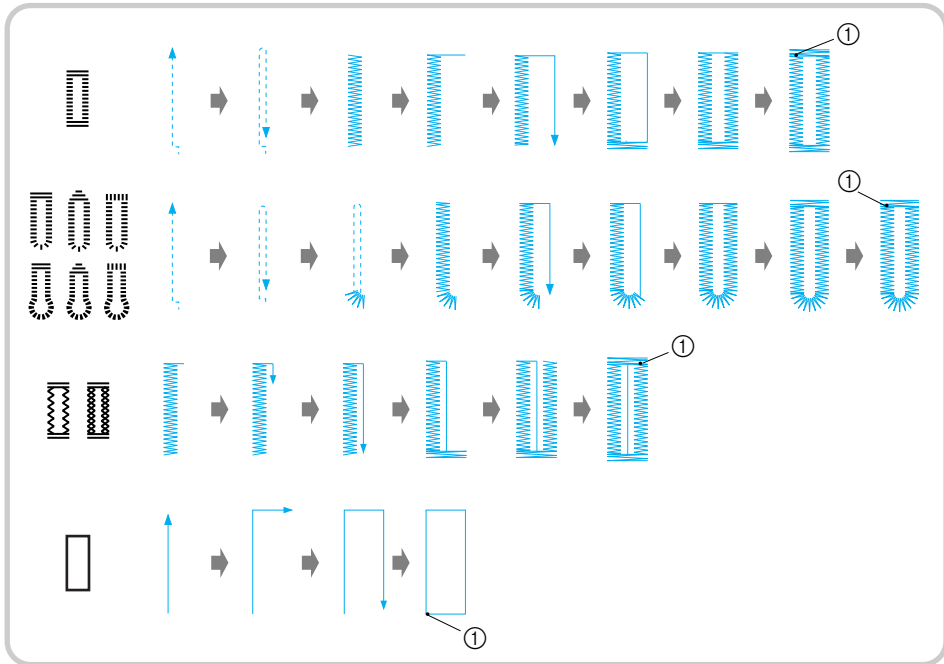

① Reinforcement stitching

The names of parts of buttonhole foot “A”, which is used for sewing buttonholes, are indicated below.

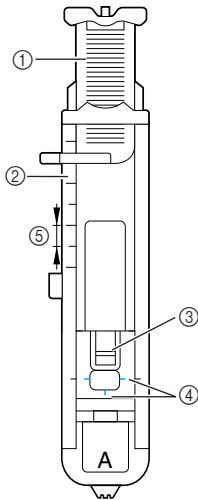

- ① Button guide plate
- ② Presser foot scale
- ③ Pin
- ④ Marks on buttonhole foot
- ⑤ 5 mm (3/16 inch)

1 Use chalk to mark on the fabric the position and length of the buttonhole.

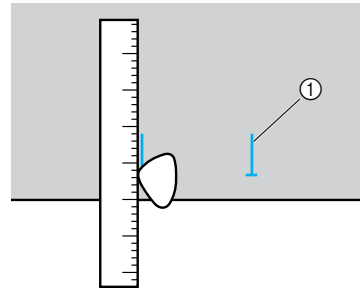

① Marks on fabric

2 Pull out the button guide plate of buttonhole foot “A”, and then insert the button that will be put through the buttonhole.

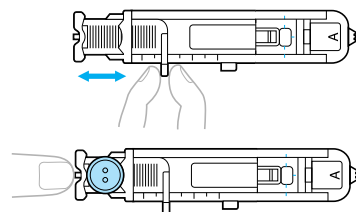

■ **If the button does not fit in the button guide plate**

Add together the diameter and thickness of the button, and then set the button guide plate to the calculated length. (The distance between the markings on the presser foot scale is 5 mm (3/16 inch).)

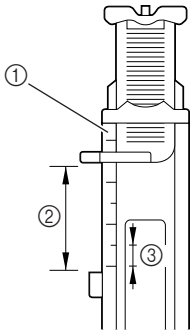

- ① Presser foot scale
- ② Length of buttonhole (diameter + thickness of button)
- ③ 5 mm (3/16 inch)

Example: For a button with a diameter of 15 mm (9/16 inch) and a thickness of 10 mm (3/8 inch), the button guide plate should be set to 25 mm (1 inch) on the scale.

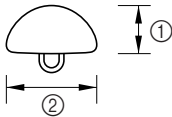

- ① 10 mm (3/8 inch)
- ② 15 mm (9/16 inch)

▶ The size of the buttonhole is set.

3 Attach buttonhole foot "A".

- For details, refer to "Replacing the presser foot" (page 44).

4 Select a stitch.

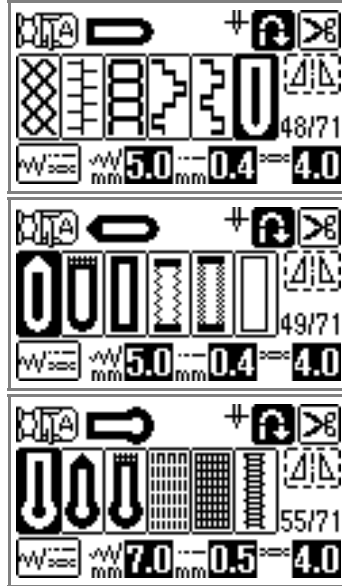

- For details, refer to "Selecting stitching" (page 51).

5 Position the fabric with the front end of the buttonhole mark aligned with the red marks on the sides of the buttonhole foot, and then lower the presser foot lever.

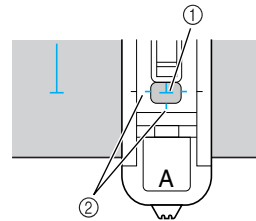

- ① Mark on fabric (front)
- ② Red marks on buttonhole foot

Pass the upper thread down through the hole in the presser foot.

- When lowering the presser foot, do not push in the front of the presser foot.

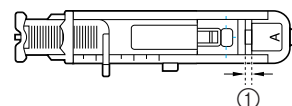
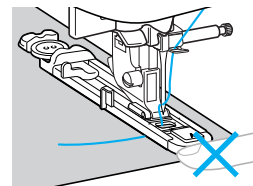

- ① Do not reduce the gap.

- 6** Pull down the buttonhole lever as far as possible.

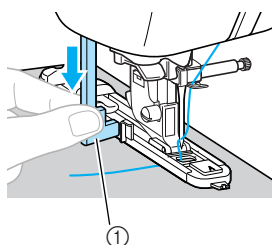

① Buttonhole lever

The buttonhole lever is positioned behind the bracket on the buttonhole foot.

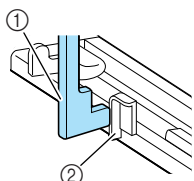

① Buttonhole lever
② Bracket

- 7** Gently hold the end of the upper thread in your left hand, and then start sewing.

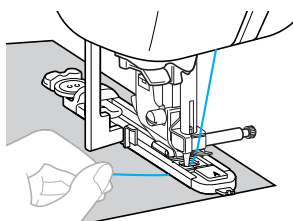

▶ Once sewing is completed, the machine automatically sews reinforcement stitches, then stops.

- 8** Raise the presser foot lever, remove the fabric, and then cut the thread.

- 9** Raise the buttonhole lever to its original position.

- 10** Insert a pin along the inside of one bar tack at the end of the buttonhole stitching to prevent the stitching from being cut.

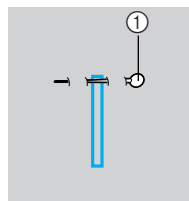

① Pin

- 11** Use the seam ripper to cut towards the pin and open the buttonhole.

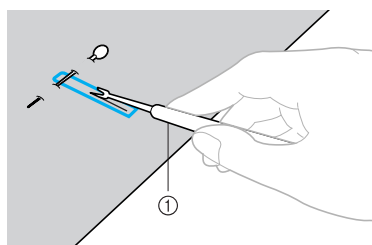

① Seam ripper

For keyhole buttonholes, use the eyelet punch to make a hole in the rounded end of the buttonhole, and then use the seam ripper to cut open the buttonhole.

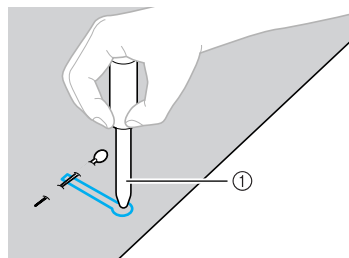

① Eyelet punch

- When using the eyelet punch, place thick paper or some other protective sheet under the fabric before punching the hole in the fabric.

CAUTION

- When opening the buttonhole with the seam ripper, do not place your hands in the cutting direction, otherwise injuries may result if the seam ripper slips.
- Do not use the seam ripper in any other way than how it is intended.

■ Changing the density of the stitching

Adjust the stitch length.

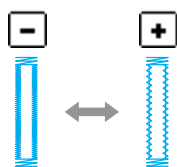

- For details, refer to “Adjusting the stitch length” (page 59).
- If the fabric does not feed (for example, if it is too thick), decrease the density of the stitching.

■ Changing the stitch width

Adjust the stitch width.

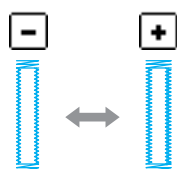

- For details, refer to “Adjusting the stitch width” (page 58).



Memo

- Before sewing buttonholes, check the stitch length and width by sewing a trial buttonhole on a scrap piece of fabric.

■ Sewing buttonholes on stretch fabrics

When sewing buttonholes on stretch fabrics, use a gimp thread.

- ① Hook the gimp thread onto the part of buttonhole foot “A” shown in the illustration.

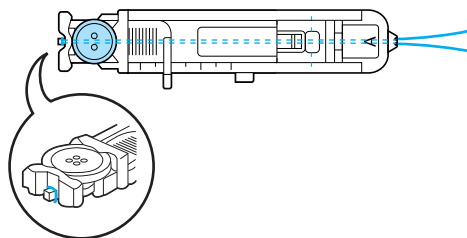

- ② It fits into the grooves, and then loosely tie it.

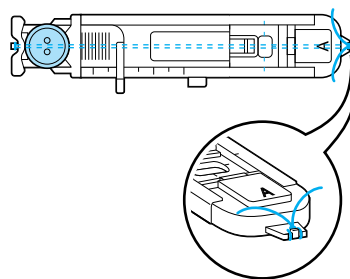

- ③ Attach buttonhole foot “A”.

- For details, refer to “Replacing the presser foot” (page 44).

- ④ Select stitch 52  or 53 .

- ⑤ Adjust the stitch width to the thickness of the gimp thread.

- ⑥ Lower the presser foot lever and the buttonhole lever, and then start sewing.

- ⑦ When sewing is finished, gently pull the gimp thread to remove any slack.

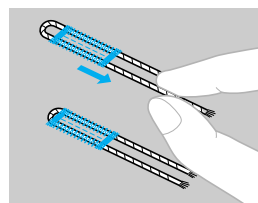

- ⑧ Use a handsewing needle to pull the gimp thread to the wrong side of the fabric, and then tie it.

Button sewing

Buttons can be sewn on with the sewing machine. Buttons with two or with four holes can be attached.

- 1 Measure the distance between the holes in the button to be attached.

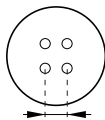

- 2 Raise the presser foot lever, and then slide the drop feed lever, located at the rear of the machine on the base, to the left (to the left as seen from the rear of the machine).

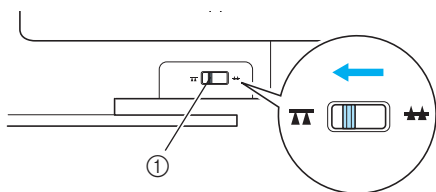

- 1 Drop feed lever (as seen from the rear of the machine)

▶ The feed dogs are lowered.

- 3 Attach button-sewing foot “M”.

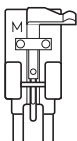

- For details, refer to “Replacing the presser foot” (page 44).

- 4 Select stitch 61.

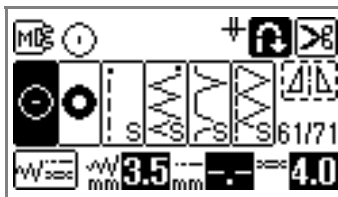

- For details, refer to “Selecting stitching” (page 51).
- Since the end of the thread will be tied off later, do not set the sewing machine for programmed-thread cutting.

- 5 Adjust the stitch width so that it is the same as the distance between the holes in the button.

- 6 Place the button in the position where it will be sewn, and lower the presser foot lever.

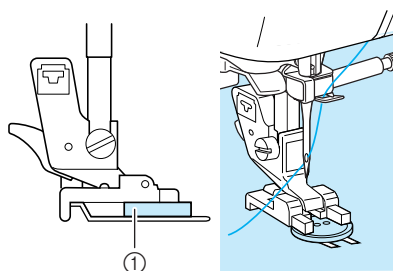

- 1 Button

▶ The button is held in place.

- When attaching four-hole buttons, first sew the two holes closest to you. Then, slide the button so that the needle goes into the two holes toward the rear of the sewing machine, and then sew them in the same way.

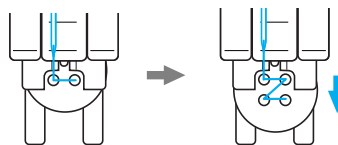

- 7** Turn the handwheel toward you (counterclockwise) to check that the needle correctly goes into the two holes of the button. If it seems as if the needle will hit the button, remeasure the distance between the holes in the button. Adjust the stitch width to the distance between the button holes.

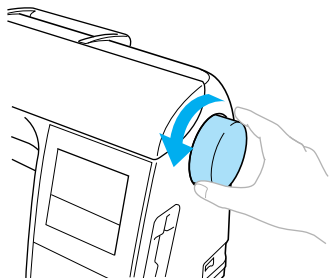

CAUTION

- When sewing, be sure that the needle does not touch the button, otherwise the needle may bend or break.

- 8** Start sewing. Set the sewing speed controller to the left (so that the speed will be slow).

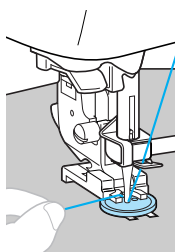

- ▶ The sewing machine automatically stops after sewing reinforcement stitches.
- Do not press  ("Thread Cutter" button).
- If additional strength is needed to secure the button, perform the button-sewing operation twice.

- 9** Use scissors to cut the upper thread and the bobbin thread at the beginning of the stitching. Pull the upper thread at the end of the stitching to the wrong side of the fabric, and then tie it with the bobbin thread.

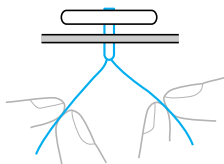

- 10** When you are finished attaching the button, slide the drop feed lever to  (to the right as seen from the rear of the machine) to raise the feed dogs.

Memo

- The feed dog position switch is normally set to the right side (as seen from the rear of machine).
- The feed dogs come up when you start sewing again.

Attaching a shank to a button

To sew the button with a shank, attach the button with space between it and the fabric, and then wind the thread by hand. This attaches the button securely.

- 1** Place the button into button-sewing foot "M", and then pull the shank lever toward you.

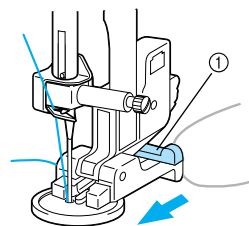

① Shank lever

- 2** After sewing is finished, cut the upper thread with plenty of excess, wind it around the thread between the button and the fabric, and then tie it to the upper thread at the beginning of the stitching.



Tie together the ends of the bobbin thread at the end and at the beginning of the stitching on the wrong side of the fabric.



- 3** Cut off any excess thread.

Zipper Insertion

A zipper can be sewn in place.

Stitch Name	Pattern	Application	Stitch Width [mm (inch)]		Stitch Length [mm (inch)]		Presser Foot
			Auto	Manual	Auto	Manual	
Straight stitch (center needle position)		Attaching zippers Sewing concealed seams and pintucks	3.5 (1/8)	0.0–7.0 (0–1/4)	2.5 (3/32)	0.2–5.0 (1/64–3/16)	

There are many methods for inserting zippers. The procedures for inserting a centered zipper and a side zipper are described below.

Inserting a centered zipper

Stitching is sewn on both pieces of fabric butted against each other.

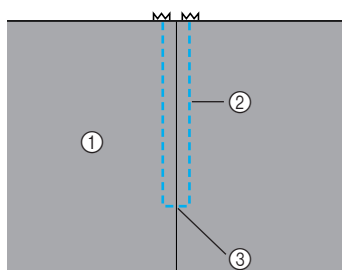

- ① Right side of fabric
- ② Stitching
- ③ End of zipper opening

1 Attach zigzag foot “J”.

2 Sew straight stitches up to the zipper opening.

With the right sides of the fabric facing each other, sew reverse stitches after reaching the zipper opening.

- For details, refer to “Basic stitching” (page 85).

3 Using a basting stitch, continue sewing to the edge of the fabric.

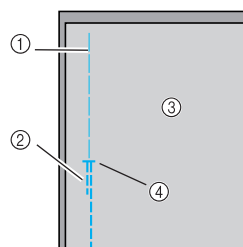

- ① Basting stitching
- ② Reverse stitches
- ③ Wrong side of fabric
- ④ End of zipper opening

4 Press open the seam allowance from the wrong side of the fabric.

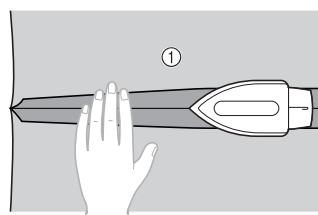

- ① Wrong side of fabric

- 5** Align the seam with the center of the zipper, and then baste the zipper in place.

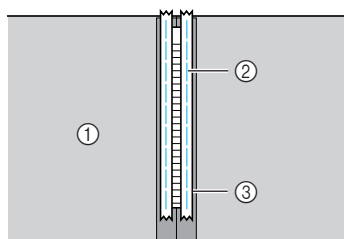

- ① Wrong side of fabric
- ② Basting stitching
- ③ Zipper

- 6** Remove about 5 cm (2 inches) from the end of the basting on the outside.

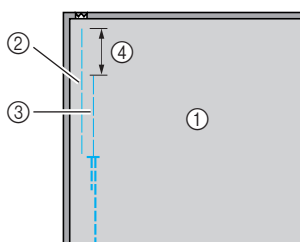

- ① Wrong side of fabric
- ② Zipper basting
- ③ Outside basting
- ④ 5 cm (2 inches)

- 7** Attach the presser foot holder to the right pin of zipper foot "1".

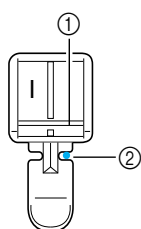

- ① Pin on the right side
- ② Needle drop point

- For details, refer to "Replacing the presser foot" (page 44).

- 8** Select stitch 3.

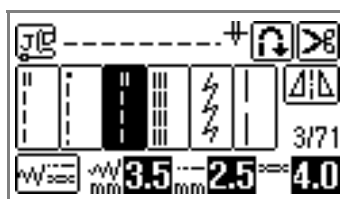

- For details, refer to "Selecting stitching" (page 51).

CAUTION

- When using zipper foot "1", be sure to select the straight stitch (center needle position), and slowly turn the handwheel toward you (counterclockwise) to check that the needle does not touch the presser foot. If a different stitch is selected or the needle hits the presser foot, the needle may bend or break.

- 9** Topstitch around the zipper.

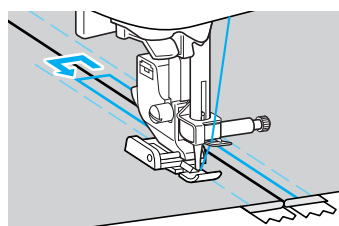
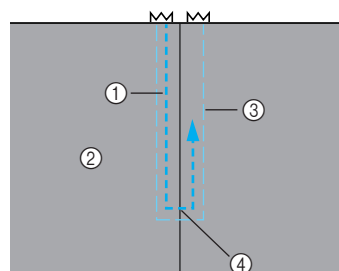

- ① Stitching
- ② Right side of fabric
- ③ Basting stitching
- ④ End of zipper opening

CAUTION

- When sewing, be sure that the needle does not touch the zipper, otherwise the needle may bend or break.

- 10** Remove the basting stitching.

Inserting a side zipper

Stitching is visible on only one piece of fabric. Use this type of zipper application for side openings and back openings.

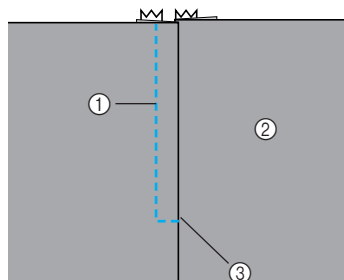

- ① Stitching
- ② Right side of fabric
- ③ End of zipper opening

The following procedure will describe how to stitch on the left side, as shown in the illustration.

- 1 Attach zigzag foot “J”.**
- 2 Sew straight stitches up to the zipper opening.**
With the right sides of the fabric facing each other, sew reverse stitches after reaching the zipper opening.
 - For details, refer to “Basic stitching” (page 85).
- 3 Using a basting stitch, continue sewing to the edge of the fabric.**

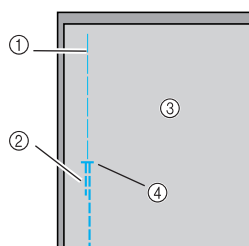

- ① Basting stitching
- ② Reverse stitches
- ③ Wrong side of fabric
- ④ End of zipper opening

- 4 Press open the seam allowance from the wrong side of the fabric.**

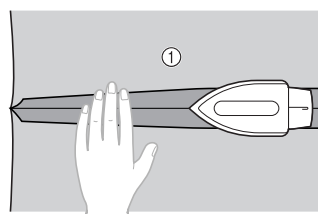

- ① Wrong side of fabric

- 5 Press the seam allowance so that the right side (the side that will not be stitched) has an extra 3 mm (1/8 inch).**

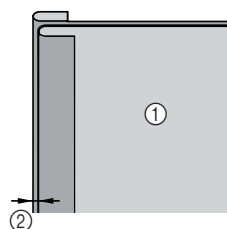

- ① Wrong side of fabric
- ② 3 mm (1/8 inch)

- 6 Align the zipper teeth with the pressed edge of the fabric having the extra 3 mm (1/8 inch), and then baste or pin the zipper in place.**

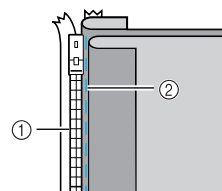

- ① Zipper teeth
- ② Basting stitching

- 7 Attach the presser foot holder to the right pin of zipper foot “I”.**

If the stitching will be sewn on the right side, attach the presser foot holder to the left pin of the zipper foot.

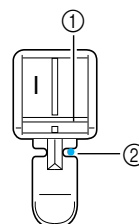

- ① Pin on the right side
- ② Needle drop point

- For details, refer to “Replacing the presser foot” (page 44).

8 Select stitch .

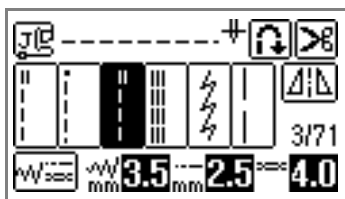

• For details, refer to “Selecting stitching” (page 51).

CAUTION

- When using zipper foot “I”, be sure to select the straight stitch (center needle position), and slowly turn the handwheel toward you (counterclockwise) to check that the needle does not touch the presser foot. If a different stitch is selected or the needle hits the presser foot, the needle may bend or break.

9 Sew the zipper to the piece of fabric with the extra 3 mm (1/8 inch), starting from the base of the zipper.

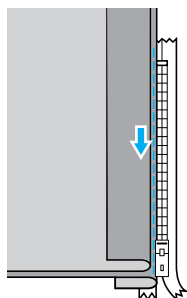

CAUTION

- When sewing, be sure that the needle does not touch the zipper, otherwise the needle may bend or break.

10 When you are about 5 cm (2 inches) from the end of the zipper, stop the sewing machine with the needle lowered (in the fabric), raise the presser foot lever.

11 Open the zipper and continue sewing.

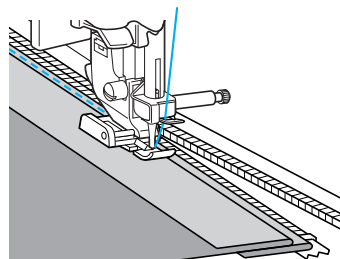

12 Close the zipper, turn over the fabric, and then baste the other side of the zipper to the fabric.

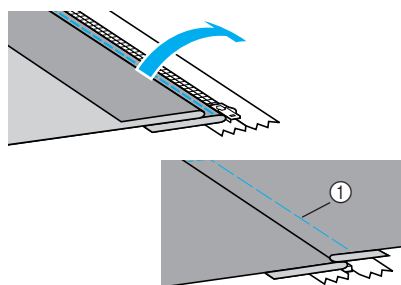

① Basting stitching

13 Attach the presser foot holder to the other pin of zipper foot “I”.

If the presser foot holder was attached to the right pin in step 7, change it to the left pin.

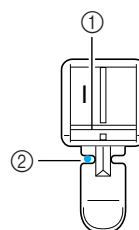

① Pin on the left side
② Needle drop point

- 14 Topstitch around the zipper.**
Sew reverse stitches at the end of the zipper opening and align the zipper teeth with the side of the presser foot.

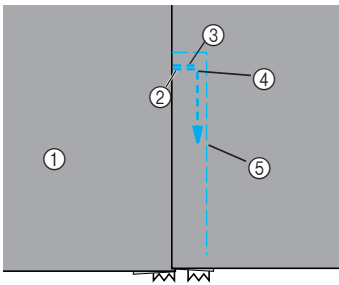

- ① Right side of fabric
- ② End of zipper opening
- ③ Reverse stitches
- ④ Beginning of stitching
- ⑤ Basting stitching

! CAUTION

- When sewing, be sure that the needle does not touch the zipper, otherwise the needle may bend or break.

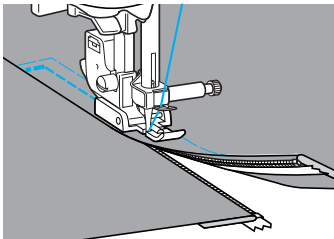

- 15** When you are about 5 cm (2 inches) from the end of the zipper, stop the sewing machine with the needle lowered (in the fabric), raise the presser foot lever, and then open the zipper and continue sewing.

- 16** Remove the basting stitching.



Zipper/piping Insertion

A zipper and piping can be sewn in place.

Stitch Name	Pattern	Application	Stitch Width [mm (inch)]		Stitch Length [mm (inch)]		Presser Foot
			Auto	Manual	Auto	Manual	
Straight stitch (left needle position)		Attaching zippers Sewing concealed seams and piping	0.0 (0)	0.0–7.0 (0–1/4)	2.5 (3/32)	0.2–5.0 (1/64–3/16)	

There are many methods for inserting zippers and pipings. The procedures for inserting a centered zipper and a piping are described below, with the adjustable zipper/piping foot.

Inserting a centered zipper

1 Refer to step **1–5** of “Inserting a centered zipper” (page 96).

2 Remove the presser foot and presser foot holder (page 46) to attach the screw-on adjustable zipper/piping foot.

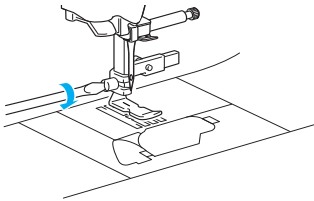

Note

- Use a screw driver to securely tighten the screw that holds the presser foot. If the screw is loose, the needle may break and cause injuries.

3 Select stitch **1**.

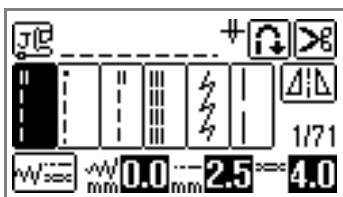

4 Loosen the positioning screw on the back of the presser foot.

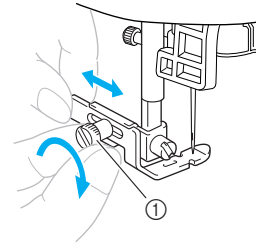

① Positioning screw

5 Slide the presser foot over either the left or right feed dog.

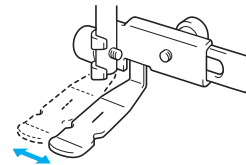

Left sewing position

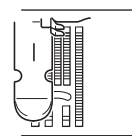

Right sewing position

6 Change the needle position so that the needle does not touch the presser foot.

For details, refer to “Adjusting the stitch width” (page 58).



① Needle drop point

CAUTION

- After adjusting the needle position, slowly turn the handwheel toward you and check the needle does not touch (counterclockwise) the presser foot. If the needle hits the presser foot, the needle may bend or break.

- 7** Securely tighten the positioning screw with a screwdriver.

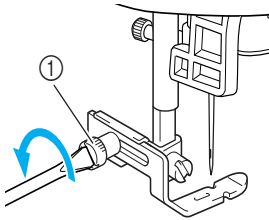

① Positioning screw

- 8** Topstitch around the zipper.

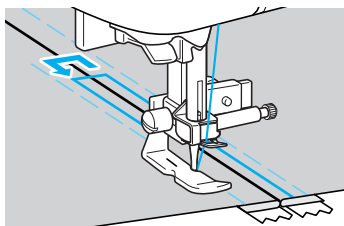
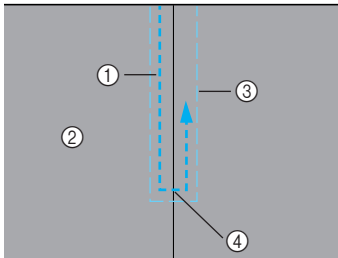

① Stitching
② Right side of fabric
③ Basting stitching
④ End of zipper opening

CAUTION

- When sewing, be sure that the needle does not touch the zipper, otherwise the needle may bend or break.

- 9** Remove the basting stitching.

Inserting a piping

- 1** Place the piping between two fabric pieces turned inside out, as shown below.

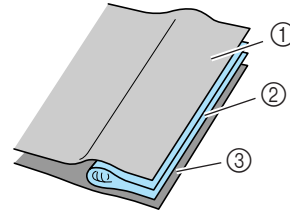

① Fabric
② Piping
③ Fabric

- 2** Refer to the steps of attaching the adjustable zipper/piping foot on the previous page.

- 3** Sew along the piping.

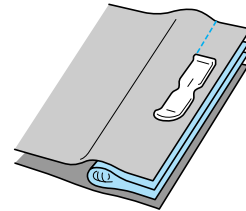



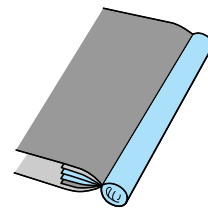

- 4** After sewing, turn fabric pieces.



Sewing Stretch Fabrics and Elastic Tape

Stretch fabrics can be sewn and elastic tape can be attached.

Stitch Name	Pattern	Application	Stitch Width [mm (inch)]		Stitch Length [mm (inch)]		Presser Foot
			Auto	Manual	Auto	Manual	
Stretch stitch	5 	Stretch fabrics	1.0 (1/16)	1.0–3.0 (1/16–1/8)	2.5 (3/32)	1.0–4.0 (1/16–3/16)	J
2-point zigzag stitch	9 	Attaching elastic	5.0 (3/16)	1.5–7.0 (1/16–1/4)	1.0 (1/16)	0.2–4.0 (1/64–3/16)	
3-point zigzag stitch	10 		5.0 (3/16)	1.5–7.0 (1/16–1/4)	1.0 (1/16)	0.2–4.0 (1/64–3/16)	
Elastic-attaching stitch	34 	Attaching elastic to stretch fabrics	4.0 (3/16)	0.0–7.0 (0–1/4)	1.0 (1/16)	0.2–4.0 (1/64–3/16)	

Observe the corresponding precautions when performing each of the following stitching operations.

Stretch stitching

1 Attach zigzag foot “J”.

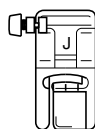

- For details, refer to “Replacing the presser foot” (page 44).

2 Select stitch 5 .

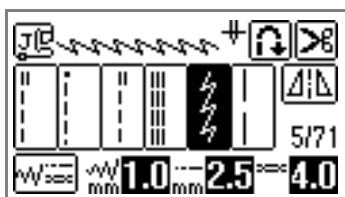

- For details, refer to “Selecting stitching” (page 51).

3 Sew the fabric without stretching it.

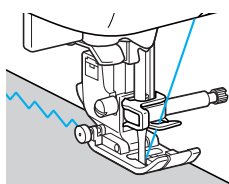

Elastic attaching

When elastic tape is attached to the cuff or waist of a piece of clothing, the finished dimensions will be that of the stretched elastic tape. Therefore, it is necessary that a suitable length of the elastic tape be used.

1 Pin the elastic tape to the wrong side of the fabric.

Pin the elastic tape to the fabric at a few points to make sure that the tape is uniformly positioned on the fabric.

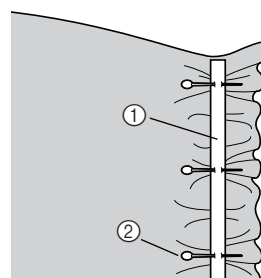

- ① Elastic tape
- ② Pin

2 Attach zigzag foot “J”.

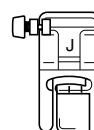

- For details, refer to “Replacing the presser foot” (page 44).

3 Select a stitch.

- **Example:** 2-point zigzag stitch

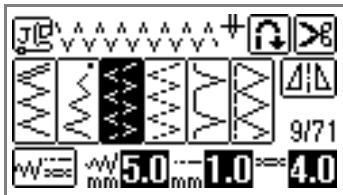

- **Example:** Elastic-attaching stitch

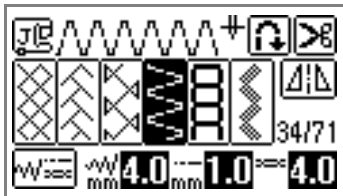

- For details, refer to “Selecting stitching” (page 51).

4 Sew the elastic tape to the fabric while stretching the tape so that it is the same length as the fabric.

While pulling the fabric behind the presser foot with your left hand, pull the fabric at the pin nearest the front of the presser foot with your right hand.

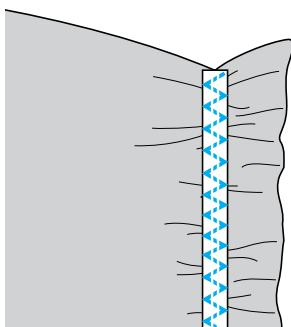
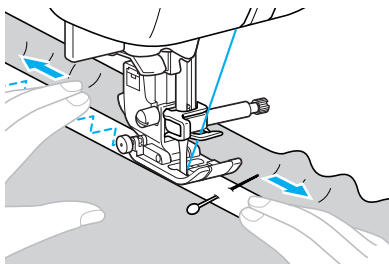











! CAUTION

- When sewing, be sure that the needle does not touch any pins, otherwise the needle may bend or break.

Appliqué, Patchwork and Quilt Stitching

The stitches that can be used for sewing appliqués, patchwork and quilts are described below.

Stitch Name	Pattern	Application	Stitch Width [mm (inch)]		Stitch Length [mm (inch)]		Presser Foot
			Auto	Manual	Auto	Manual	
Zigzag stitch		Attaching appliqués (center baseline/reverse stitching)	3.5 (1/8)	0.0–7.0 (0–1/4)	1.4 (1/16)	0.0–4.0 (0–3/16)	J
		Appliqué quilting, free-motion quilting, satin stitching	3.5 (1/8)	0.0–7.0 (0–1/4)	1.4 (1/16)	0.0–4.0 (0–3/16)	
Appliqué stitch		Attaching appliqués	3.5 (1/8)	2.5–7.0 (3/32–1/4)	2.5 (3/32)	1.6–4.0 (1/16–3/16)	
		Attaching appliqués and binding	1.5 (1/16)	0.5–3.5 (1/32–1/8)	1.8 (1/16)	1.0–4.0 (1/16–3/16)	
Piecing straight stitch		Piecing straight stitching (with a seam allowance of 6.5 mm (1/4 inch) from the right edge of the presser foot)	5.5 (7/32)	0.0–7.0 (0–1/4)	2.0 (1/16)	0.2–5.0 (1/64–3/16)	
		Piecing straight stitching (with a seam allowance of 6.5 mm (1/4 inch) from the left edge of the presser foot)	1.5 (1/16)	0.0–7.0 (0–1/4)	2.0 (1/16)	0.2–5.0 (1/64–3/16)	
Joining stitch		Patchwork stitching	4.0 (3/16)	0.0–7.0 (0–1/4)	1.2 (1/16)	0.2–4.0 (1/64–3/16)	
			5.0 (3/16)	2.5–7.0 (3/32–1/4)	2.5 (3/32)	1.0–4.0 (1/16–3/16)	
			5.0 (3/16)	0.0–7.0 (0–1/4)	1.2 (1/16)	0.2–4.0 (1/64–3/16)	
Mock hand quilting stitch		Straight stitch quilting that looks hand quilting	0.0 (0)	0.0–7.0 (0–1/4)	2.5 (3/32)	1.0–4.0 (1/16–3/16)	
Quilting stippling		Stippling	7.0 (1/4)	1.0–7.0 (1/16–1/4)	1.6 (1/16)	1.0–4.0 (1/16–3/16)	



Memo

- Patterns showing a “Q” on the LCD are for quilting and those showing a “P” are for piecing.

Appliqué stitching

For best results, use the included open toe foot.

- 1 Cut out the appliqué, leaving a seam allowance of between 3 and 5 mm (1/8 and 3/16 inch).

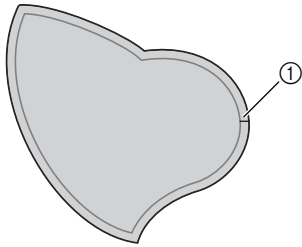

① Seam allowance

- 2 Place a pattern made of thick paper or stabilizer on the back of the appliqué, and then fold over the seam allowance using an iron.

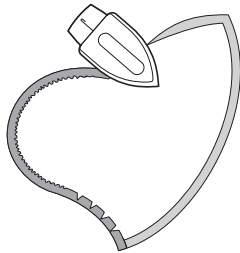

- 3 Turn the fabric over, and then baste or fuse it onto the fabric that it will be attached to.

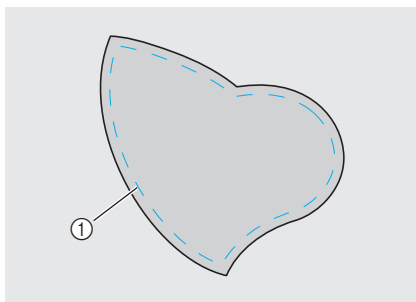

① Basting stitching

- 4 Attach the open toe foot.

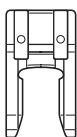

- For details, refer to “Replacing the presser foot” (page 44).

- 5 Select a stitch.

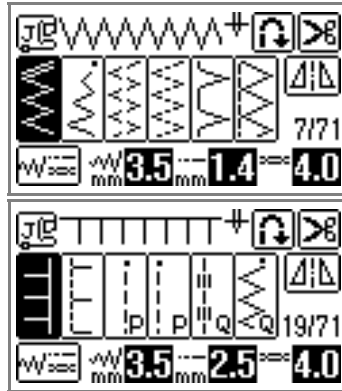

- For details, refer to “Selecting stitching” (page 51).

- 6 Turn the handwheel toward you (counterclockwise), and then begin sewing around the edge of the appliqué, making sure that the needle drops just outside of the appliqué.

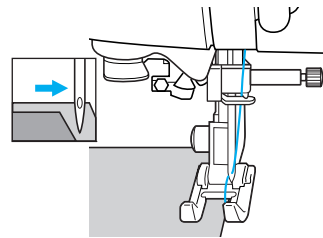

When sewing around corners, stop the machine with the needle in the fabric just outside of the appliqué, raise the presser foot lever, and then turn the fabric as needed to change the sewing direction.

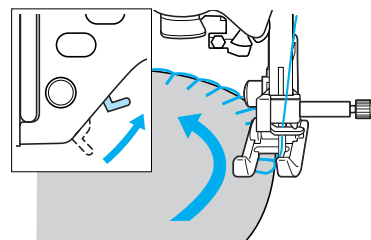

Patchwork (crazy quilt) stitching

- 1 Fold the edge of the top piece of fabric and place it over the lower piece.
- 2 Sew the two pieces of fabric together so the pattern spans over both pieces.

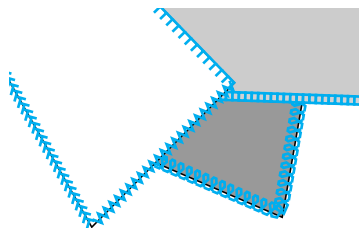
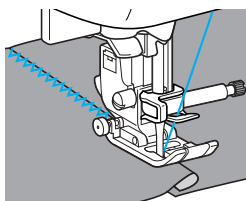

Piecing

Sewing together two pieces of fabric is called “piecing”. The fabric pieces should be cut with a 7 mm (1/4 inch) seam allowance. Sew a piecing straight stitch 7 mm (1/4 inch) from either the right side or the left side of the presser foot.

- 1 Baste or pin along the seam allowance of the fabric that you wish to piece together.
- 2 Attach zigzag foot “J”.

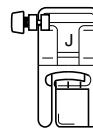

- For details, refer to “Replacing the presser foot” (page 44).

- 3 Select stitch ²¹ or ²².

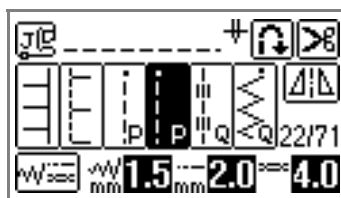

- For details, refer to “Selecting stitching” (page 51).
- The piecing straight stitch shows a “P” on the LCD.

- 4 Sew with the side of the presser foot aligned with the edge of the fabric.

■ For a seam allowance on the right side

Align the right side of the presser foot with the edge of the fabric, and sew using stitch ²¹.

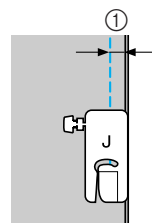

- ① 7 mm (1/4 inch)

■ **For a seam allowance on the left side**

Align the left side of the presser foot with the edge of the fabric, and sew using stitch 22 .

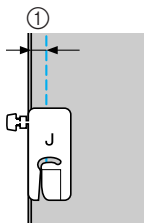

① 7 mm (1/4 inch)



Memo

- To change the width of the seam allowance (needle position), adjust the stitch width. For details, refer to “Adjusting the stitch width” (page 58).

■ **Using the optional 1/4 inch quilting foot**

If the 1/4 inch quilting foot is used, seams can be sewn with a seam allowance of 6.4 mm (1/4 inch).

① **Baste or pin along the seam allowance of the fabric that you wish to piece together.**

② **Attach the 1/4 inch quilting foot.**

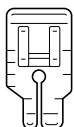

- For details, refer to “Replacing the presser foot” (page 44).

③ **Select stitch 3 .**

④ **Align the mark at the upper edge of the 1/4 inch quilting foot with the upper edge of the fabric.**

Align the right edge of the fabric with the right edge of the narrow part of the 1/4 inch quilting foot.

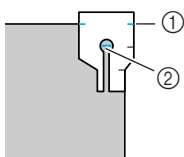

① Mark on 1/4 inch quilting foot
② Beginning of stitching

When sewing with a seam allowance, align the left edge of the narrow part of the 1/4 inch quilting foot with the fabric edge.

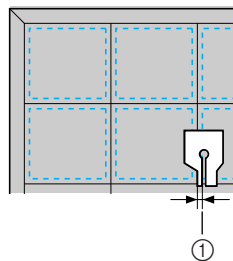

① Seam (3.2 mm (1/8 inch))

⑤ **Start sewing.**

⑥ **When the end of the stitching is reached, stop the sewing machine.**

Sew until the mark at the lower edge of the 1/4 inch quilting foot aligns with the lower edge of the fabric.

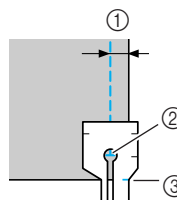

① 6.4mm (1/4 inch)
② End of stitching
③ Mark on 1/4 inch quilting foot

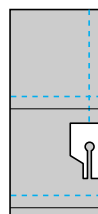

Quilting

Sandwiching batting between the top and bottom layers of fabric is called “quilting”. Quilts can easily be sewn using the optional walking foot and the optional quilting guide.

- 1 **Baste the fabric to be quilted.**
- 2 **Remove the presser foot and the presser foot holder.**
 - For details, refer to “Removing and attaching the presser foot holder” (page 46).
- 3 **Hook the connecting fork of the walking foot onto the needle clamp screw.**

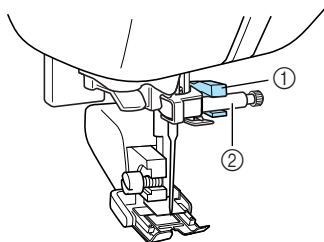

- ① Connecting fork
- ② Needle clamp screw

- 4 **Lower the presser foot lever, insert the presser foot holder screw, and then tighten the screw with the screwdriver.**

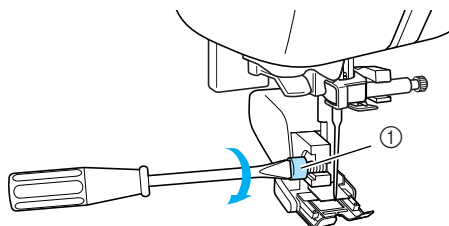

- ① Presser foot holder screw
- ▶ The walking foot is attached.

! CAUTION

- Be sure to securely tighten the screws with the screwdriver, otherwise the needle may touch the presser foot, causing it to bend or break.
- Before starting to sew, slowly turn the handwheel toward you (counterclockwise) and check that the needle does not touch the presser foot. If the needle hits the presser foot, the needle may bend or break.

- 5 **Select a stitch.**
 - For details, refer to “Selecting stitching” (page 51).
- 6 **Place one hand on each side of the presser foot, and hold fabric taut while sewing.**

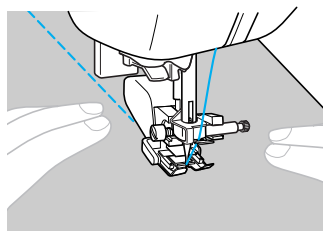

☀ Note

- When sewing with the walking foot, sew at a speed between slow and medium.
- When quilting, use a 90/14 home sewing machine needle.

■ **Using the optional quilting guide**

Use the quilting guide to sew parallel stitches that are equally spaced.

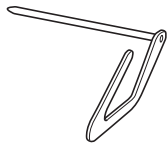

1 Insert the stem of the quilting guide into the hole at the rear of the walking foot or presser foot holder.

Walking foot

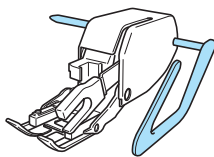

Presser foot holder

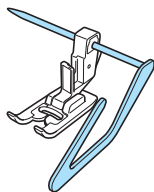

2 Adjust the stem of the quilting guide so that the guide aligns with the seam that has already been sewn.

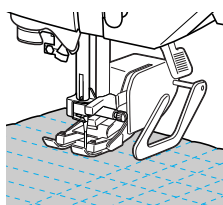

Note

- The optional quilting guide is available through brother dealer.

Free-motion quilting

With free-motion quilting, lower the feed dogs (using the drop feed lever) so that the fabric can be moved freely in any direction.

When free-motion quilting, use the following instructions with the optional quilting foot.

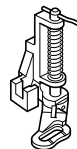

1 Remove the presser foot and the presser foot holder.

- Refer to “Removing and attaching the presser foot holder” (page 46).

2 Secure the quilting foot with the presser foot holder screw.

The pin on the quilting foot should be positioned over the needle clamp screw.

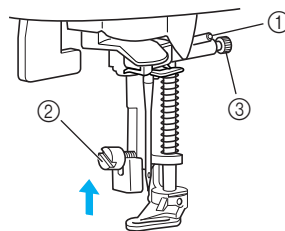

- ① Pin on quilting foot
- ② Presser foot holder screw
- ③ Needle clamp screw

3 Hold the quilting foot in place with your right hand, and then tighten the presser foot holder screw using the screwdriver in your left hand.

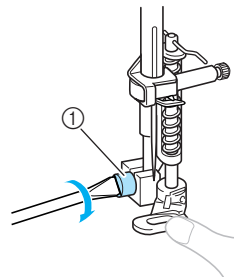

- ① Presser foot holder screw

CAUTION

- Be sure to securely tighten the screws with the screwdriver, otherwise the needle may touch the presser foot, causing it to bend or break.

- 4 Slide the drop feed lever, located at the rear of the machine on the base, to  (to the left as seen from the rear of the machine).

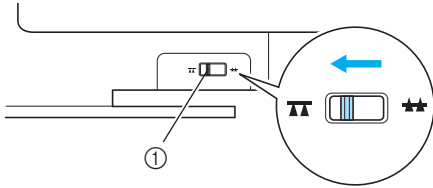

- ① Feed dog position switch (as seen from the rear of the machine)

▶ The feed dogs are lowered.

- 5 Turn on the sewing machine, and then select a stitch.

- For details, refer to “Selecting stitching” (page 51).

- 6 Use both hands to hold the fabric taut, and then move the fabric to follow the pattern. Reinforcement stitches are sewn at the beginning and end of sewing.

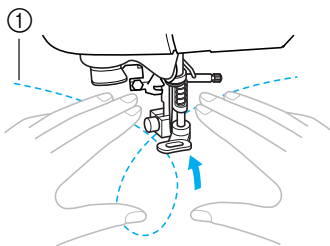

- ① Pattern

- 7 After sewing is finished, slide the drop feed lever to  (to the right as seen from the rear of the machine) to raise the feed dogs.

- Normally, the drop feed lever is positioned at the right.

Satin stitching using the sewing speed controller

A decorative stitch can be sewn by changing the stitch width of a satin stitch. If the sewing machine is set so that the stitch width can be adjusted using the sewing speed controller, the stitch width can quickly and easily be adjusted. In this case, the sewing speed is adjusted with the foot controller.

- 1 Connect the foot controller.

- For details, refer to “Starting to sew” (page 53).

- 2 Attach zigzag foot “J”.

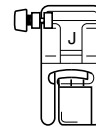

- For details, refer to “Replacing the presser foot” (page 44).

- 3 Turn on the sewing machine, and then press  (Settings key) on the operation panel.

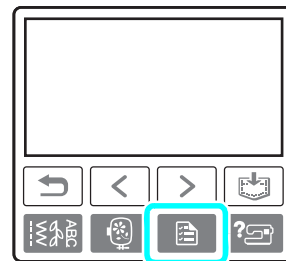



▶ The settings screen appears.

- 4 Press ON for stitch width control setting.



▶ The machine is now set so that the stitch width can be controlled with the sewing speed controller.

If the stitch width control setting is set to “ON”,  for stitch width will change to sewing speed controller icon .

5 Press  (Back key).

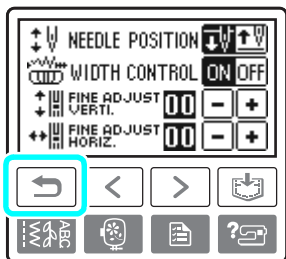

▶ The initial screen appears again.

6 Select stitch .

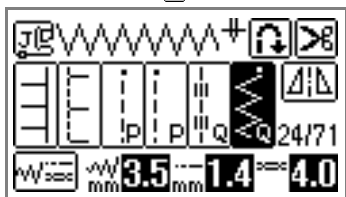

- For details, refer to “Selecting stitching” (page 51).

7 While sewing, slide the sewing speed controller to adjust the stitch width. Slide the controller to the left to make the width narrower. Slide the controller to the right to make the width wider.

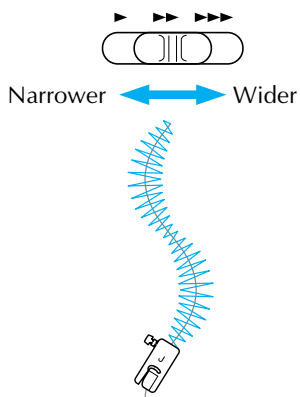

- Adjust the sewing speed with the foot controller.

8 When you are finished sewing, set the stitch width control setting back to OFF.







Memo

- Although the stitching result differs depending on the type of fabric being sewn and the thickness of the thread being used, for best results, adjust the stitch length to between 0.3 and 0.5 mm (1/64 and 1/32 inch).

Reinforcement Stitching

Reinforce points that will be subject to strain, such as sleeve holes, inseams and pocket corners.

Stitch Name	Pattern	Application	Stitch Width [mm (inch)]		Stitch Length [mm (inch)]		Presser Foot
			Auto	Manual	Auto	Manual	
Triple stretch stitch	4 	Reinforcing the seams of sleeves and inseams	0.0 (0)	0.0–7.0 (0–1/4)	2.5 (3/32)	1.5–4.0 (1/16–3/16)	J
Bar tack stitch	60 	Reinforcing the ends of openings, such as the corners of pockets	2.0 (1/16)	1.0–3.0 (1/16–1/8)	0.4 (1/64)	0.3–1.0 (1/64–1/16)	A
Darning stitch	58 	Darning medium weight fabrics	7.0 (1/4)	2.5–7.0 (3/32–1/4)	2.0 (1/16)	0.4–2.5 (1/64–3/32)	
		59 	Darning thick fabrics	7.0 (1/4)	2.5–7.0 (3/32–1/4)	2.0 (1/16)	0.4–2.5 (1/64–3/32)

Triple stretch stitching

Use triple stretch stitching to reinforce sleeve holes and inseams.

1 Attach zigzag foot “J”.

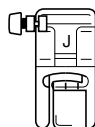

- For details, refer to “Replacing the presser foot” (page 44).

2 Select stitch 4 .

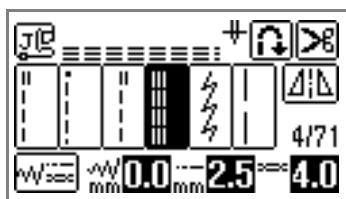

- For details, refer to “Selecting stitching” (page 51).

3 Start sewing.

- For details, refer to “Starting to sew” (page 53).

Bar tack stitching

Bar tacks are used to reinforce points subject to strain, such as pocket corners and openings.

As an example, the procedure for sewing bar tacks at pocket corners is described below.

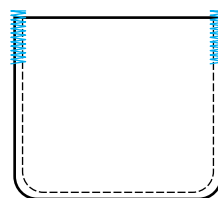

1 Determine the desired length of the bar tack.

Set the button guide plate on buttonhole foot “A” to the desired length. (The distance between the markings on the presser foot scale is 5 mm (3/16 inch).)

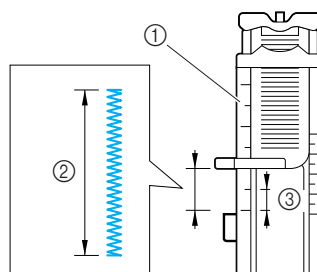

- ① Presser foot scale
- ② Length of bar tack
- ③ 5 mm (3/16 inch)

- A bar tack with a maximum length of about 28 mm (1–1/8 inches) can be sewn.

2 Attach buttonhole foot “A”.

- For details, refer to “Replacing the presser foot” (page 44).

3 Select stitch 60 .

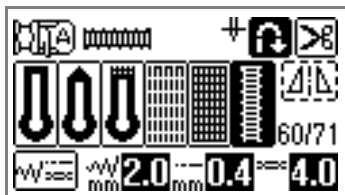

- For details, refer to “Selecting stitching” (page 51).

4 Position the fabric so that the opening of the pocket faces toward you, and then lower the presser foot lever so that the needle drops 2 mm (1/16 inch) in front of the pocket opening.

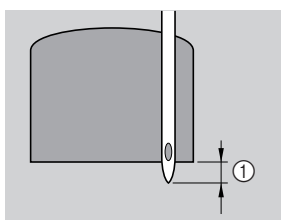

① 2 mm (1/16 inch)

Pass the upper thread down through the hole in the presser foot.

- When lowering the presser foot, do not push in the front of the presser foot, otherwise the bar tack will not be sewn with the correct size.

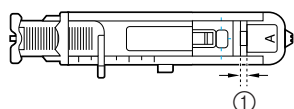
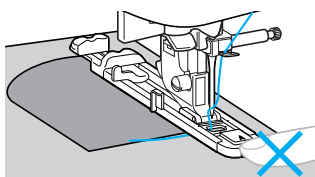

① Do not reduce the gap.

5 Pull down the buttonhole lever as far as possible.

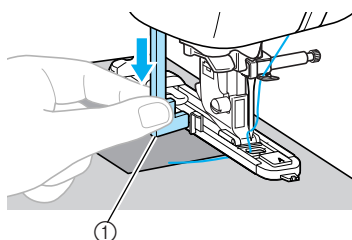

① Buttonhole lever

The buttonhole lever is positioned behind the bracket on the buttonhole foot.

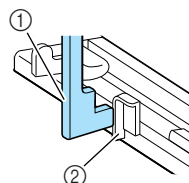

① Buttonhole lever
② Bracket

6 Gently hold the end of the upper thread in your left hand, and then start sewing.

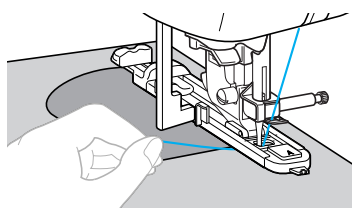

- ▶ Once sewing is completed, the machine automatically sews reinforcement stitches, then stops.

7 Raise the presser foot lever, remove the fabric, and then cut the threads.

8 Raise the buttonhole lever to its original position.



Memo

- If the fabric does not feed, for example, because it is too thick, increase the stitch length. For details, refer to “Adjusting the stitch length” (page 59).

Darning

Fabric that has been torn can be darned.
Darning is sewn as shown below.

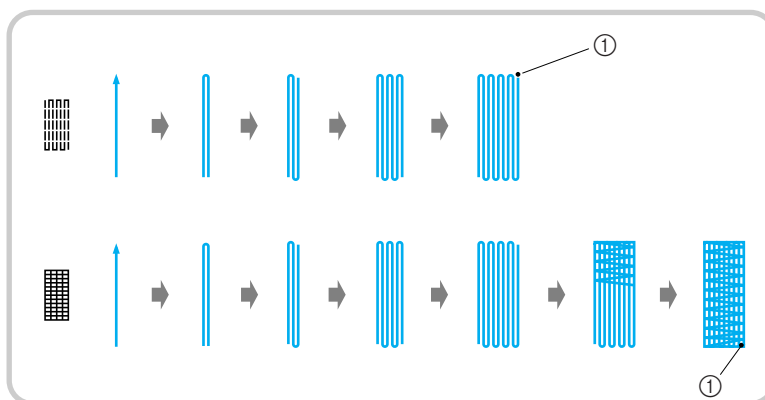

① Reinforcement stitching

- Determine the desired length of the darning.** Set the button guide plate on buttonhole foot "A" to the desired length. (The distance between the markings on the presser foot scale is 5 mm (3/16 inch).)

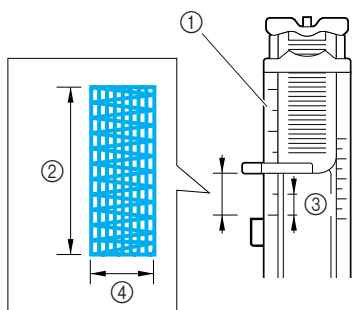

- Presser foot scale
- Length of darning
- 5 mm (3/16 inch)
- 7 mm (1/4 inch)

- Attach buttonhole foot "A".**

- For details, refer to "Replacing the presser foot" (page 44).

- Select stitch 58 or 59.**

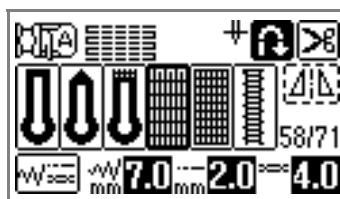

- For details, refer to "Selecting stitching" (page 51).

- Position the fabric so that the needle is 2 mm (1/16 inch) in front of the area to be darned, and then lower the presser foot lever.**

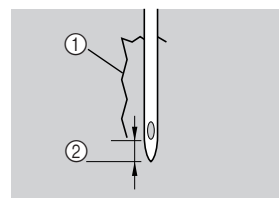

- Tear
- 2 mm (1/16 inch)

Pass the upper thread down through the hole in the presser foot.

- When lowering the presser foot, do not push in the front of the presser foot, otherwise the darning will not be sewn with the correct size.

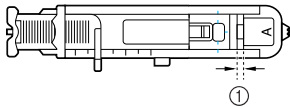
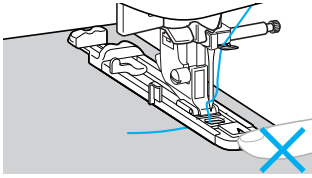

- ① Do not reduce the gap.

5 Pull down the buttonhole lever as far as possible.

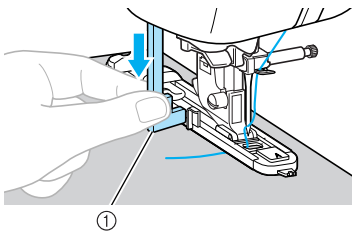

- ① Buttonhole lever

The buttonhole lever is positioned behind the bracket on the buttonhole foot.

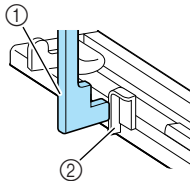

- ① Buttonhole lever
② Bracket

6 Gently hold the end of the upper thread in your left hand, and then start sewing.

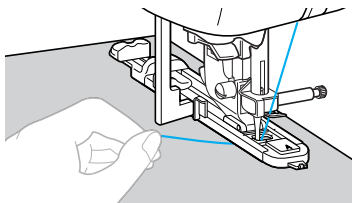

- Once sewing is completed, the machine automatically sews reinforcement stitches, then stops.

7 Raise the presser foot lever, remove the fabric, and then cut the threads.

8 Raise the buttonhole lever to its original position.



Memo

- If the fabric does not feed, for example, because it is too thick, increase the stitch length. For details, refer to “Adjusting the stitch length” (page 59).

Eyelet Stitching

Eyelets, such as those on belts, can be sewn. Three sizes of eyelets are possible: 7 mm, 6 mm and 5 mm (1/4, 15/64 and 3/16 inch).

Stitch Name	Pattern	Application	Stitch Width [mm (inch)]		Stitch Length [mm (inch)]		Presser Foot
			Auto	Manual	Auto	Manual	
Eyelet stitch	62 	Sewing eyelets, for example, on belts	7.0 (1/4)	7.0, 6.0 or 5.0 (1/4, 15/64 or 3/16)	7.0 (1/4)	7.0, 6.0 or 5.0 (1/4, 15/64 or 3/16)	N

1 Attach monogramming foot "N".

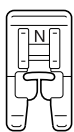

- For details, refer to "Replacing the presser foot" (page 44).

2 Select stitch 62 .

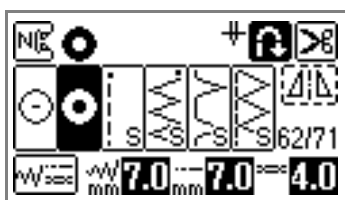

- For details, refer to "Selecting stitching" (page 51).

3 Adjust either the stitch width or the stitch length to select the desired eyelet size.

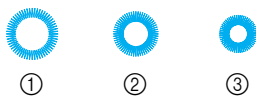

- ① 7mm
- ② 6mm
- ③ 5mm

- For details, refer to "Adjusting the stitch width" (page 58) and "Adjusting the stitch length" (page 59).

4 Lower the needle into the fabric at the beginning of the stitching, and then lower the presser foot lever.

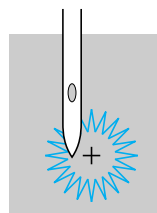

5 Start sewing.

- ▶ Once sewing is completed, the machine automatically sews reinforcement stitches, then stops.

6 Use the eyelet punch to cut a hole in the center of the eyelet.

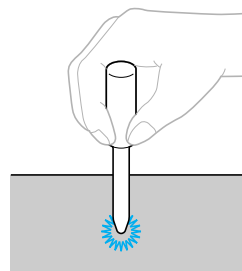





- When using the eyelet punch, place thick paper or some other protective sheet under the fabric before punching the hole in the fabric.

Memo

- If light weight thread is used, the stitching may be sparse. If this occurs, sew the eyelet twice before removing the fabric, one on top of the other.

Horizontal Stitching

Horizontal stitching is used to attach appliqués to fabric that cannot be moved around, such as cylindrical pieces. Straight stitches and zigzag stitches that sew to either the left or right are available.

Stitch Name	Pattern	Application	Stitch Width [mm (inch)]	Stitch Length [mm (inch)]	Presser Foot
Horizontal straight stitch	68 	Attaching appliqués to sleeves (straight stitch sewn to the left)	—	—	N
	69 	Attaching appliqués to sleeves (straight stitch sewn to the right)	—	—	
Horizontal zigzag stitch	70 	Attaching appliqués to sleeves (zigzag stitch sewn to the left)	—	—	
	71 	Attaching appliqués to sleeves (zigzag stitch sewn to the right)	—	—	

The illustration below shows the sewing order for the following explanation.

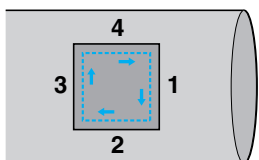



1 Remove the flat bed attachment.

- For details, refer to “Free-arm sewing” (page 47).

2 Attach monogramming foot “N”.

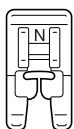
- For details, refer to “Replacing the Presser Foot” (page 44).



3 Select stitch 1 .

- For details, refer to “Selecting stitching” (page 51).

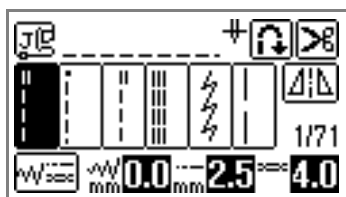

4 Lower the needle into the fabric at the beginning of the stitching, and then start sewing.

Lower the needle at the upper-right corner.

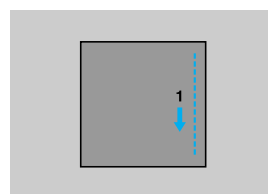

- ▶ The fabric is fed toward the back of the machine, as usual.

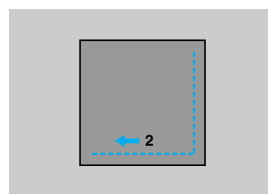

5 After you have sewn to the corner, stop the sewing machine, and then select stitch 68 .

6 Start sewing.



- ▶ The fabric is fed to the right.

7 After you have sewn to the corner, stop the sewing machine, and then select stitch 1 .

- 8** Press  (“Reverse/Reinforcement Stitch” button).
Hold  (“Reverse/Reinforcement Stitch” button) pressed until the stitching reaches the upper-left corner.

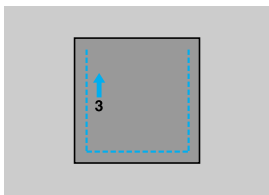

▶ The fabric is fed forward.

- 9** After you have sewn to the corner, stop the sewing machine, and then select stitch .

- 10** Start sewing.

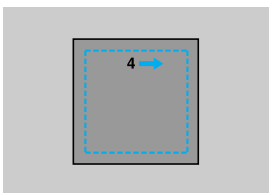

▶ The fabric is fed to the left.

- 11** After you have sewn to the corner, stop the sewing machine, and then select stitch  again.

- 12** After sewing 3 to 5 stitches at the beginning of the stitching, stop the sewing machine.

























Memo

- The feeding direction of the fabric differs depending on the stitch that is selected. Be sure to guide the fabric while it is sewn.

Decorative Stitching

The utility stitches contain the following decorative stitches.

Stitch Name	Pattern	Application	Stitch Width [mm (inch)]		Stitch Length [mm (inch)]		Presser Foot	
			Auto	Manual	Auto	Manual		
Fagoting stitch	32 	Sewing two pieces of fabric together across an open seam	5.0 (3/16)	0.0–7.0 (0–1/4)	2.5 (3/32)	1.0–4.0 (1/16–3/16)	J	
	33 		5.0 (3/16)	2.5–7.0 (3/25–1/4)	2.5 (3/32)	1.0–4.0 (1/16–3/16)		
Joining stitch	28 	Decorative bridging stitches	4.0 (3/16)	0.0–7.0 (0–1/4)	1.2 (1/16)	0.2–4.0 (1/64–3/16)		
	29 		5.0 (3/16)	2.5–7.0 (3/32–1/4)	2.5 (3/32)	1.0–4.0 (1/16–3/16)		
	30 		5.0 (3/16)	0.0–7.0 (0–1/4)	1.2 (1/16)	0.2–4.0 (1/64–3/16)		
Shell tuck stitch	20 	Shell tuck stitching on collars and curves	4.0 (3/16)	0.0–7.0 (0–1/4)	2.5 (3/32)	0.2–4.0 (1/64–3/16)		
Smocking stitch	31 	Smocking fabrics to add texture and elasticity	5.0 (3/16)	0.0–7.0 (0–1/4)	1.6 (1/16)	1.0–4.0 (1/16–3/16)		
	32 		5.0 (3/16)	0.0–7.0 (0–1/4)	2.5 (3/32)	1.0–4.0 (1/16–3/16)		
	33 		5.0 (3/16)	2.5–7.0 (3/32–1/4)	2.5 (3/32)	1.0–4.0 (1/16–3/16)		
Scallop stitch	27 	Satin scallop stitching	5.0 (3/16)	2.5–7.0 (3/32–1/4)	0.5 (1/32)	0.1–1.0 (1/64–1/16)		
Hemstitching	39 	Lace sewing, decorative hemming, heirloom stitching, etc.	3.5 (1/8)	1.5–7.0 (1/16–1/4)	2.5 (3/32)	1.6–4.0 (1/16–3/16)		N
	40 		6.0 (15/64)	1.5–7.0 (1/16–1/4)	3.0 (1/8)	1.5–4.0 (1/16–3/16)		
	41 	Decorative hemming and heirloom stitching, etc. on thin, medium weight and plain weave fabrics	5.0 (3/16)	1.5–7.0 (1/16–1/4)	3.5 (1/8)	1.5–4.0 (1/16–3/16)		
	42 		5.0 (3/16)	1.5–7.0 (1/16–1/4)	4.0 (3/16)	1.5–4.0 (1/16–3/16)		
	43 		5.0 (3/16)	1.5–7.0 (1/16–1/4)	2.5 (3/32)	1.5–4.0 (1/16–3/16)		
	44 		5.0 (3/16)	1.5–7.0 (1/16–1/4)	2.0 (1/16)	1.5–4.0 (1/16–3/16)		
45 	Decorative hemming, ribbon threading, heirloom stitching, etc.	5.0 (3/16)	1.5–7.0 (1/16–1/4)	3.0 (1/8)	1.5–4.0 (1/16–3/16)			

Stitch Name	Pattern	Application	Stitch Width [mm (inch)]		Stitch Length [mm (inch)]		Presser Foot
			Auto	Manual	Auto	Manual	
Hemstitching	46 	Heirloom stitching, etc.	6.0 (15/64)	1.5–7.0 (1/16–1/4)	1.6 (1/16)	1.0–4.0 (1/16–3/16)	N
	47 		5.0 (3/16)	1.5–7.0 (1/16–1/4)	1.6 (1/16)	1.0–4.0 (1/16–3/16)	
Ladder stitch	35 	Decorative stitching	4.0 (3/16)	0.0–7.0 (0–1/4)	3.0 (1/8)	2.0–4.0 (1/16–3/16)	J
Rick-rack stitch	36 		4.0 (3/16)	0.0–7.0 (0–1/4)	2.5 (3/32)	1.0–4.0 (1/16–3/16)	
Decorative stitch	37 		5.5 (7/32)	0.0–7.0 (0–1/4)	1.6 (1/16)	1.0–4.0 (1/16–3/16)	
Serpentine stitch	38 		5.0 (3/16)	1.5–7.0 (1/16–1/4)	1.0 (1/16)	0.2–4.0 (1/64–3/16)	

Fagoting

Stitching across an open seam is called “fagoting”. It is used on blouses and children's clothing. This stitch is more decorative when thicker thread is used.

- Use an iron to fold the two pieces of fabric along their seams.
- Baste the two pieces of fabric, separated by about 4 mm (3/16 inch), onto thin paper or a sheet of water-soluble stabilizer. If you draw a line down the middle of the thin paper or water-soluble stabilizer, sewing is easier.

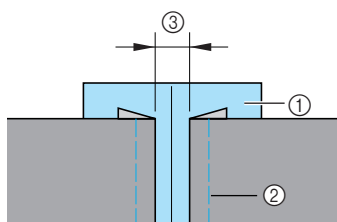

- Thin paper or water soluble stabilizer
- Basting stitching
- 4 mm (3/16 inch)

- Attach zigzag foot “J”.

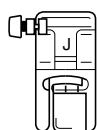

- For details, refer to “Replacing the presser foot” (page 44).

- Select stitch 32  or 33 .

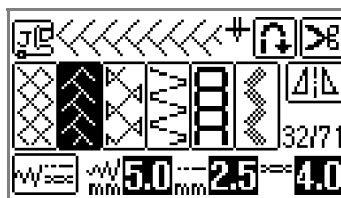

- For details, refer to “Selecting stitching” (page 51).

- Set the stitch width to 7.0 mm (1/4 inch).

- For details, refer to “Adjusting the stitch width” (page 58).

- Sew with the center of the presser foot aligned along the center of the two pieces of fabric.

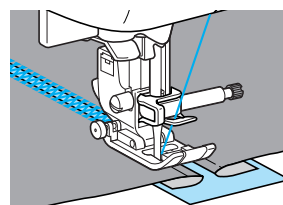
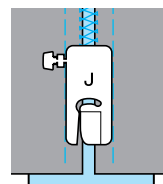

- After sewing is finished, remove the paper.

Scallop stitching

The wave-shaped repeating pattern that looks like shells is called “scalloping”. It is used on the collars of blouses and to decorate the edges of projects.

1 Attach monogramming foot “N”.

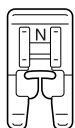

- For details, refer to “Replacing the presser foot” (page 44).

2 Select stitch ²⁷ 3.

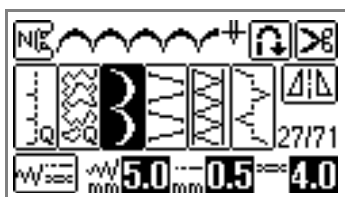

- For details, refer to “Selecting stitching” (page 51).

3 Stitch along the edge of the fabric, making sure not to sew directly on the edge of the fabric.

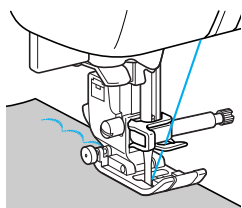

- For better results, apply spray starch the fabric and press with a hot iron before it is sewn.

4 Trim along the stitches.

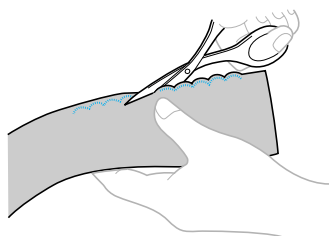

- Be careful not to cut the stitches.

Smocking

The decorative stitch created by stitching or embroidering over gathers is called “smocking”. It is used to decorate the front of blouses or cuffs. The smocking stitch adds texture and elasticity to fabric.

1 Attach zigzag foot “J”.

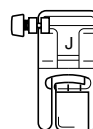

- For details, refer to “Replacing the presser foot” (page 44).

2 Select the straight stitch, and then adjust the stitch length to 4.0 mm (3/16 inch) and loosen the thread tension.

- For details, refer to “Adjusting the stitch length” (page 59) and “Adjusting the thread tension” (page 59).
- Pull up the bobbin thread. For details, refer to “Pulling up the bobbin thread” (page 39).

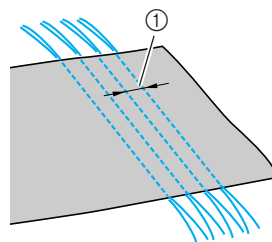

3 Sew parallel stitching at intervals of 1 cm (3/8 inch).

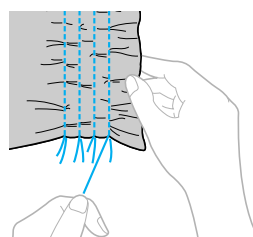

- ① 1 cm (3/8 inch)
- Do not use reverse/reinforcement stitching or thread cutting.
- At the end of the stitching, the thread is pulled out about 5 cm (2 inches).

4 Pull the bobbin threads to create gathers. Smooth the gathers by ironing them.



- 5 Select stitch ³¹ , ³²  or ³³ .

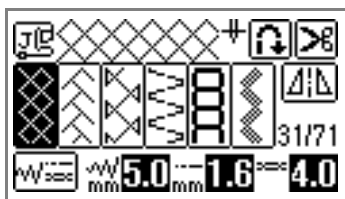

- For details, refer to “Selecting stitching” (page 51).

- 6 Stitch between the straight stitches.

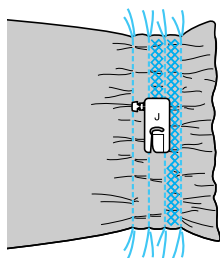

- 7 Pull out the threads for the straight stitches.

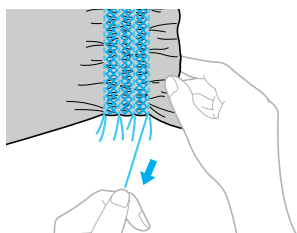

Shell tuck stitching

The gathers that look like shells are called “shell tucks”. They are used to decorate trims, the front of blouses or cuffs made of thin fabrics.

- 1 Fold the fabric along the bias.

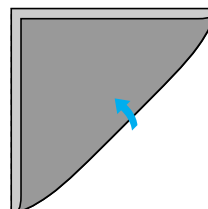

- 2 Attach zigzag foot “J”.

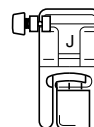

- For details, refer to “Replacing the presser foot” (page 44).

- 3 Select stitch ²⁰ , and then increase the thread tension.

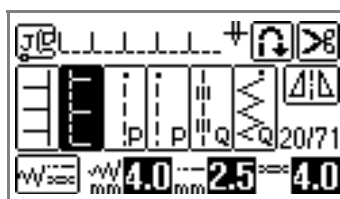

- For details, refer to “Selecting stitching” (page 51) and “Adjusting the thread tension” (page 59).

- 4** Sew while making sure that the needle drops slightly off the edge of the fabric.

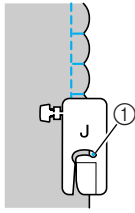

① Needle drop point

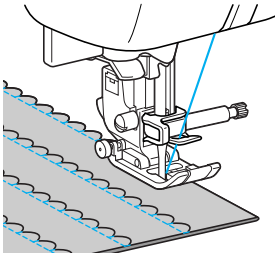

- 5** Unfold the fabric, and then iron the tucks down to one side.

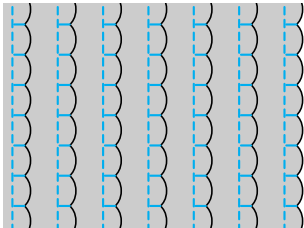

Joining

Decorative bridging stitches can be sewn over the seam allowance of joined fabrics. This is used when making a crazy quilt.

- 1** Attach zigzag foot “J”.

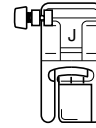

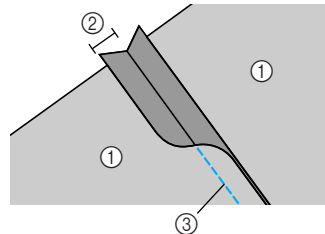

- For details, refer to “Replacing the presser foot” (page 44).

- 2** Sew together the right sides of the two pieces of fabric, and then open up the seam allowances.



- ① Wrong side of fabric
- ② 7 mm (1/4 inch) seam allowance
- ③ Straight stitch

- 3** Select stitch ²⁸ , ²⁹  or ³⁰ .

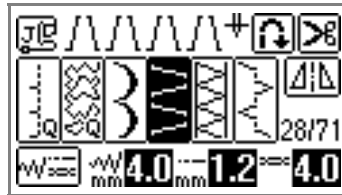

- For details, refer to “Selecting stitching” (page 51).

- 4** Turn the fabric over so that the right side faces up, and then sew over the seam with the center of the presser foot aligned with the seam.

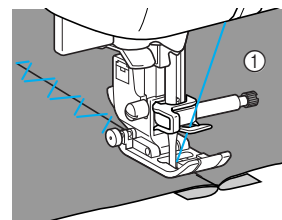

① Right side of fabric

Heirloom stitching

When sewing with the wing needle, the needle holes are enlarged, creating a lace-like decorative stitch. This is used to decorate hems and tablecloths on thin or medium weight fabrics in addition to plain weave fabrics.



Note

- If the thread becomes tangled, use stabilizer material.

1 Install the wing needle.







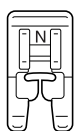



- Use a 130/705H 100/16 wing needle.
- For details on installing a needle, refer to “Replacing the needle” (page 42).
- The needle threader cannot be used with the wing needle, otherwise the sewing machine may be damaged. Manually pass the thread through the eye of the needle from the front to the back.
For details, refer to “Threading the needle manually (without using the needle threader)” (page 35).

2 Attach monogramming foot “N”.



- For details, refer to “Replacing the presser foot” (page 44).

3 Select a stitch.

The stitches that can be used are ³⁹, ⁴⁰, ⁴¹, ⁴², ⁴³, ⁴⁴, ⁴⁵, ⁴⁶ or ⁴⁷.

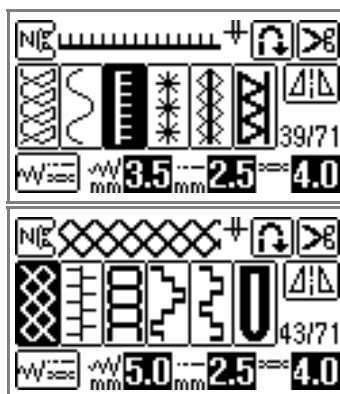

- For details, refer to “Selecting stitching” (page 51).
- When sewing with the wing needle, select a stitch width of 6.0 mm (15/64 inch) or less.

4 Start sewing.

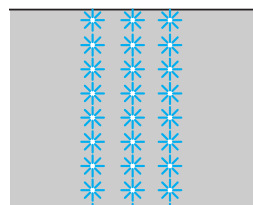

! CAUTION

- When sewing with the wing needle, select a stitch width of 6.0 mm (15/64 inch) or less, otherwise the needle may bend or break.
- After adjusting the stitch width, slowly turn the handwheel toward you (counterclockwise) and check that the needle does not touch the presser foot. If the needle hits the presser foot, the needle may bend or break.

Partially removing threads is called “drawnwork”. This gives a beautiful result with fabrics that have a loose weave. Two ways to create drawnwork are described below.

■ Drawnwork (Example 1)

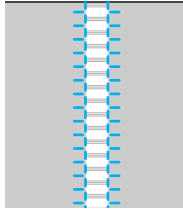

① Pull out several threads from the fabric.

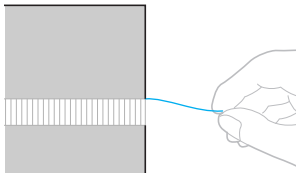

② Attach monogramming foot “N”.

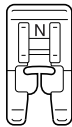

- For details, refer to “Replacing the presser foot” (page 44).

③ Select stitch 39.

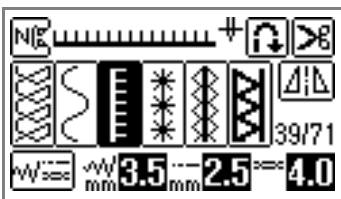

- For details, refer to “Selecting stitching” (page 51).

④ With the right side of the fabric facing up, sew along the right edge of the frayed section.

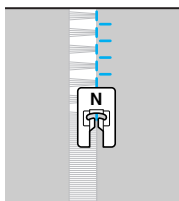

⑤ Press on the LCD.

- ▶ The pattern displayed at the top of the screen is mirrored.

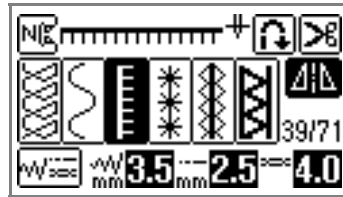

⑥ Sew along the other edge of the frayed section so that it looks like the previous stitching.

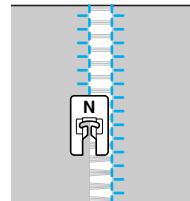

⑦ Press , and set the horizontal mirror image key back to OFF.

■ Drawnwork (Example 2)

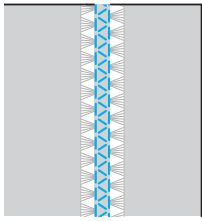

1 Pull out several threads from two sections of the fabric, separated by an unfrayed section of about 4 mm (3/16 inch).

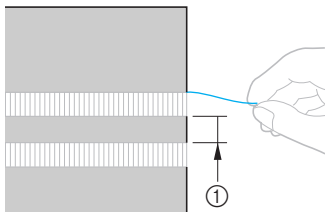

① 4 mm (3/16 inch)

2 Attach monogramming foot “N”.

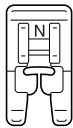

- For details, refer to “Replacing the presser foot” (page 44).

3 Select stitch .

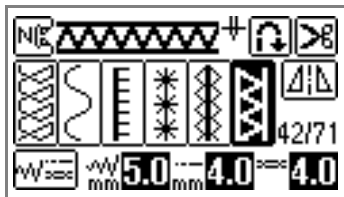

- For details, refer to “Selecting stitching” (page 51).

4 Sew along the center of the unfrayed section.

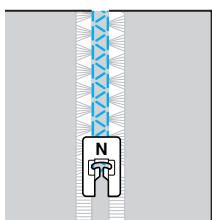

Sewing the Various Built-in Decorative Patterns

You can sew decorative stitches, satin stitches, cross stitches, decorative satin stitches, combined utility stitches and 3 types of character stitches. All are sewn with monogramming foot “N”.

Sewing beautiful patterns

In order to sew the patterns correctly, the following must be considered.

■ Fabric

Before sewing stretch or thin fabrics or fabrics with a coarse weave, affix stabilizer material to the wrong side of the fabric or place a thin sheet of paper, such as tracing paper, under the fabric. Since material puckering or bunched stitches may occur when satin stitches are sewn, be sure to affix stabilizer material to the fabric.

■ Needles and threads

When sewing thin, medium weight or stretch fabrics, use the ball point needle. When sewing thick fabrics, use a 90/14 home sewing machine needle. In addition, #50 to #60 thread should be used.

■ Trial sewing

Depending on the type and thickness of the fabric being sewn and whether or not stabilizer material is used, the desired result may not be achieved. Be sure to sew a trial piece of fabric before sewing your project. In addition, while sewing, be sure to guide the fabric with your hands in order to prevent the fabric from slipping.

Sewing patterns

1 Attach monogramming foot “N”.

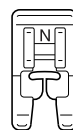

- For details, refer to “Replacing the presser foot” (page 44).

2 Select a stitch.

- For details, refer to steps 1 through 5 of “Selecting stitching” (page 77).

3 Start sewing.

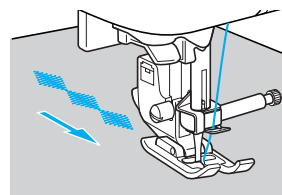

- The stitching is sewn in the direction indicated by the arrow.

4 Sew reinforcement stitches.

When sewing with a character stitch, reinforcement stitches are automatically sewn after each character.

- When sewing a pattern with a stitch other than a character stitch, it is useful to first set the automatic reverse/reinforcement stitching setting. For details, refer to “Automatically sewing reverse/reinforcement stitches” (page 61).

5 When you are finished sewing, use scissors to trim off any excess threads at the beginning of the stitching and between the patterns.



Memo

- For details on adjusting the stitch width and length, refer to “Adjusting the stitch width” (page 58) and “Adjusting the stitch length” (page 59).

Changing the pattern size

The size of character stitches in the Gothic font and outline style, decorative stitches, and decorative satin stitches can be switched between large and small. However, the size of other patterns cannot be changed.

1 Select a stitch.

- For details on selecting a stitch, refer to “Selecting stitching” (page 77).

2 Press **LS** until the desired size is selected.



3 Repeat steps 1 and 2.

LEAFLEAF



Memo

- The large pattern size is the default. If the small pattern size is selected, small patterns can be combined and connected.
- If multiple patterns have been combined, the size of each selected pattern can be specified.

Changing the stitch density

If a decorative satin stitch has been selected, the stitch density can be changed.

1 Press **UTILITY STITCH** (Utility stitch key) on the operation panel, and select **DECORATIVE SATIN STITCH** (Decorative satin stitch).



2 Select a decorative satin stitch pattern.

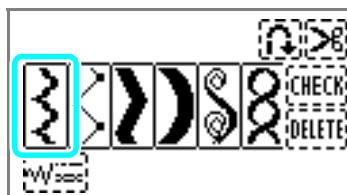

3 Press **STITCH DENSITY** until the desired stitch density is selected.

Select **SPARSE STITCHING** for sparse stitching, or select **COMPACT STITCHING** for compact stitching.



! CAUTION

- If the stitching density is too compacted, depending on the needle, the stitches may be bunched together, causing the needle to break.

Changing the length for satin stitches

The length for one satin stitch can be changed in five gradations.

- 1 Press  (Utility stitch key) on the operation panel, and select  (Satin stitch).

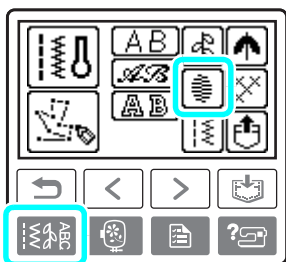

- 2 Select a satin stitch pattern.

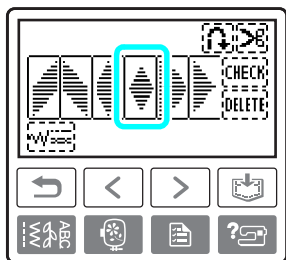
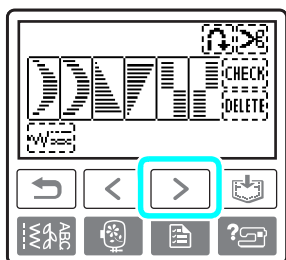

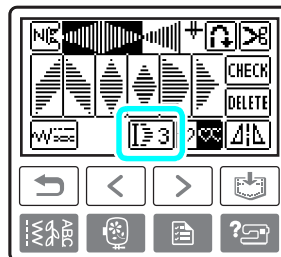

- 3 Press .



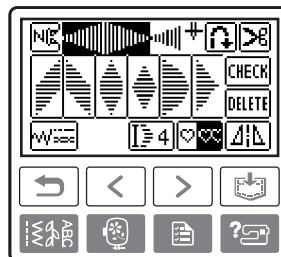

- ▶ It turns to  and the pattern is longer.

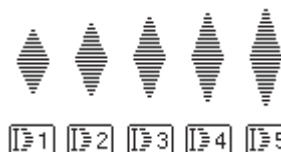

Each time you press it the number changes. You can select from  - .



Shifting patterns

Satin stitches can be shifted to the left or right by half the width of the pattern, allowing you to create a step-shaped pattern. This is called a “step pattern”. Select  once to move the stitch pattern to the left by half the width of the stitch pattern. Select  once to move the stitch pattern to the right by half the width of the stitch pattern. As an example, the procedure for creating the following pattern is described below.



- 1 Press  (Utility stitch key) on the operation panel, and select  (Satin stitch).

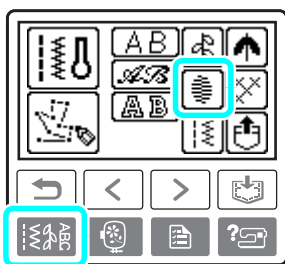

- 2 Select a satin stitch pattern.

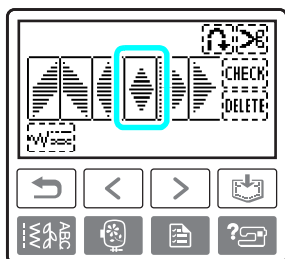
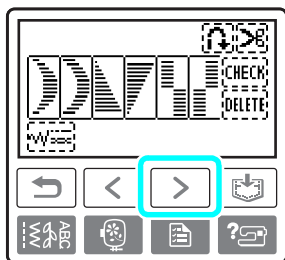

- 3 Press .

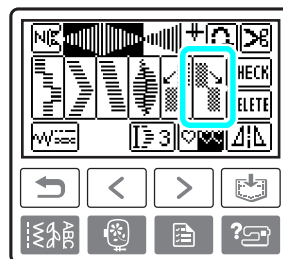
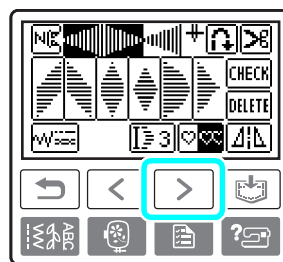

- ▶ The next pattern selected is moved half a width to the right.

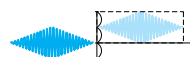

- 4 Select the same pattern.

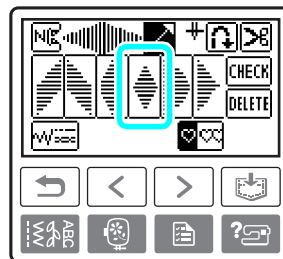

5 Press .

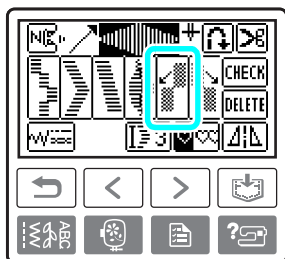

▶ The next pattern selected is moved half a width to the left.



6 Specify that the patterns will be sewn repeatedly.

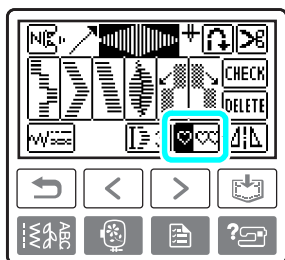

• For details, refer to “Repeating patterns” (page 133).

■ Examples of step patterns

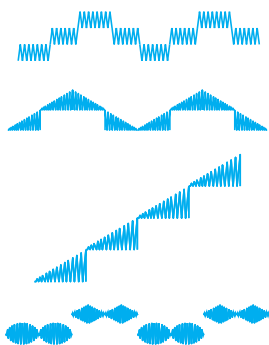

Combining patterns

You can sew with combinations of stitches from character stitches, decorative stitches, satin stitches, combined utility stitches, decorative satin stitches and cross stitches.

1 Touch  (Utility stitch key) on the operation panel, and select the stitch type.

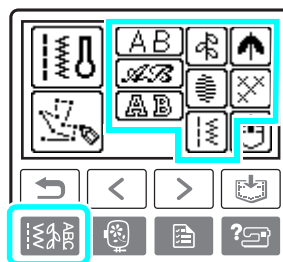

2 Select the first pattern.

▶ The first pattern is selected and appears in on the screen.

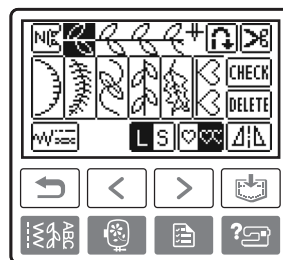

• When the sewing is started, the selected pattern is sewn repeatedly until the sewing machine is stopped.

3 Select the next pattern.

- ▶ The combined pattern appears on the screen.

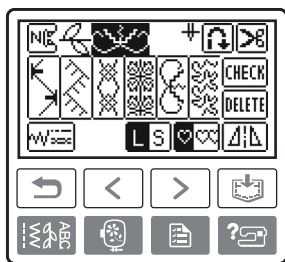

- To remove a selected pattern, press **DELETE** on the screen. The pattern that was selected last is removed.
- To combine patterns from different types, press **↶** (Back key), and after selecting the type, select the next pattern.

4 After all of the desired patterns are selected, start sewing.

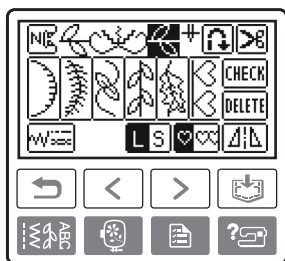

- ▶ The order that the patterns appear on the screen is the order that they will be sewn.



Memo

- Up to 70 patterns can be combined.
- If multiple patterns have been combined, the sewing machine stops once all the selected patterns displayed in the LCD have been sewn. To repeatedly sew the combined pattern, refer to “Repeating patterns”.
- The combined pattern can be saved for later use. For details, refer to “Saving patterns” (page 135).



■ Repeating patterns

When multiple stitches are combined, the sewing machine stops when the pattern displayed on the screen has been completed. Use the following operations to sew a combined pattern repeatedly.

1 After the patterns have been combined, press .

If pressed again, it turns to  (single sewing).



- ▶  turns to , and you can now sew the specified pattern repeatedly.

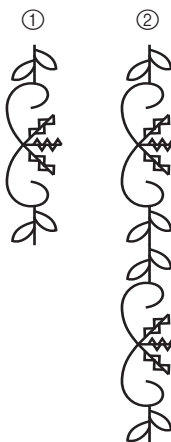

- ① Single
- ② Repeated

Note

- If repeated sewing is set, the pattern is repeatedly sewn until the sewing machine is stopped.
- If the sewing machine is turned off, the repeated/single sewing setting returns to its default setting.

■ Mirroring a pattern image

- 1 After a single pattern has been selected, press  to mirror the pattern image horizontally.





■ Checking the pattern

When the specified pattern is not displayed on the screen, check the pattern using the following steps.

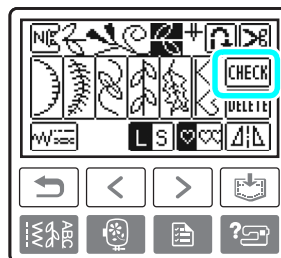
- 1 Press .



- ▶ The screen for checking the pattern is displayed.

- 2 Press  , and confirm the pattern.

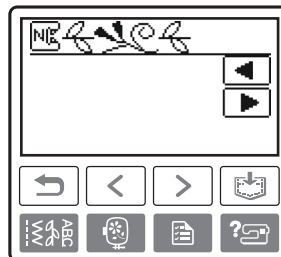
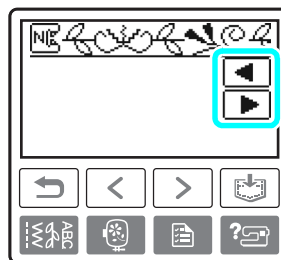

- 3 Press  (Back key).

- ▶ The initial screen appears again.

 **Memo**

- The combined pattern can be saved for later use. For details, refer to "Saving patterns" (page 135).

Saving patterns

Combined patterns can be saved for later use. Since saved patterns are not lost after the sewing machine is turned off, they can be retrieved at any time. Up to 10 patterns can be saved.

■ Saving a pattern

1 Create the combined pattern that you wish to save.

- For details, refer to “Combining patterns” (page 132).

2 Press (Memory key) on the operation panel.



- ▶ “Saving...” appears while the pattern is being saved. After the pattern is saved, the initial screen appears again.

- Do not turn off the sewing machine while the pattern is being saved, otherwise the pattern data may be lost.

■ Retrieving a pattern

1 Press .

Retrieve the saved pattern.

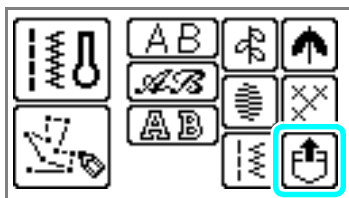

- ▶ The screen for selecting a pocket appears.

2 Select the pocket where the combined pattern you wish to retrieve is stored.

 indicates pockets where patterns are already saved.

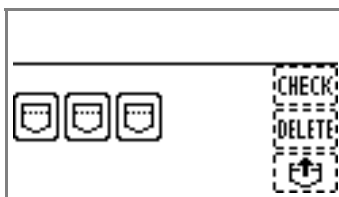

- ▶ The selected pocket is shown in reverse highlighting, and the saved pattern is displayed.

3 Check the contents, and then press .

Press  to check a pattern that is not displayed completely.



- ▶ The saved pattern is retrieved.
- ▶ The pattern selection screen appears, and you can sew the pattern you have retrieved.



■ Deleting a saved pattern

Saved pattern in the pockets can be deleted.

1 Press .

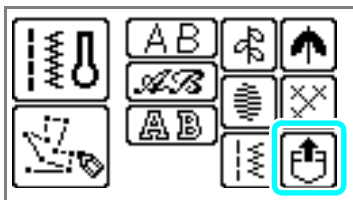

2 Select the pocket where the pattern you wish to delete is stored.

 indicates pockets where patterns are already saved.



▶ The selected pocket is shown in reverse highlighting, and the saved pattern is displayed.

3 Check the contents, then press .

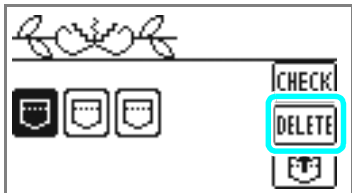

▶ The confirmation message is displayed.

4 Press .

▶ The saved pattern and the pocket are deleted.



Realigning the pattern

The pattern may not be sewn correctly, depending on the type of fabric being sewn or the sewing speed. If this occurs, adjust the pattern while sewing on a piece of scrap fabric that is the same as that used for your project.

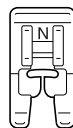
1 Attach monogramming foot “N”.



• For details, refer to “Replacing the presser foot” (page 44).

2 Press  (Utility stitch key) on the operation panel, and select  (Decorative stitch).



▶ The screen containing the various decorative stitches appears.

3 Select .

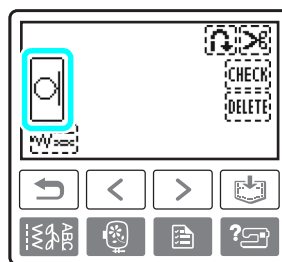

▶ The pattern alignment stitch is selected.

4 Start sewing.

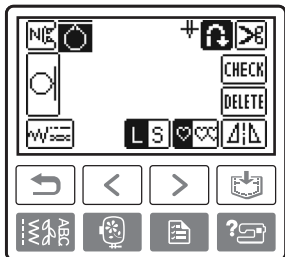

- ▶ The pattern for making the adjustment is sewn.
- ▶ The sewing machine stops after it has finished sewing the pattern.

5 Check the sewn pattern.

If the part of the pattern indicated in the illustration is sewn uniformly, the pattern is correctly aligned.

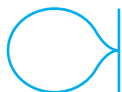

If the pattern appears as shown below, the stitching is misaligned in the vertical direction.

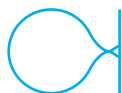

If the pattern appears as shown below, the stitching is misaligned in the horizontal direction.





If the pattern is not sewn correctly, follow the steps below to adjust the sewing.

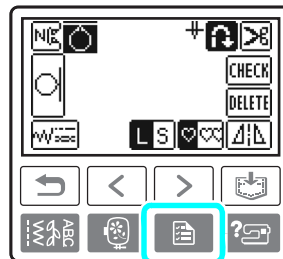

6 Press (Settings key) on the operation panel.



- ▶ The settings screen appears.

7 Press .

To adjust the vertical position, press   for vertical pattern adjustment.

To adjust the horizontal position, press   for horizontal pattern adjustment.

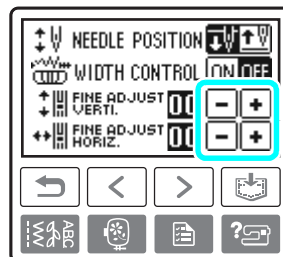

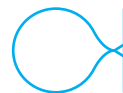

- ▶ Make the necessary adjustments according to how the pattern is sewn.

■ Vertical pattern adjustment

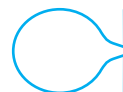
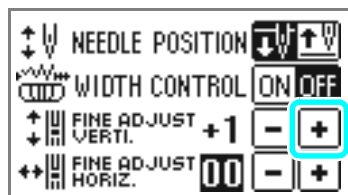

Press  to increase the vertical space in the design.



Press  to decrease the vertical space in the design.

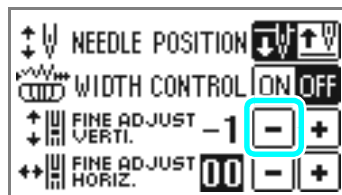

■ Horizontal pattern adjustment



Press **[+]** to increase the horizontal space in the design.

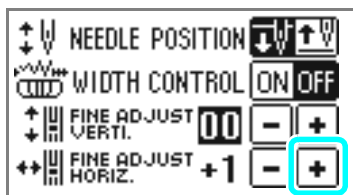

Press **[-]** to decrease the horizontal space in the design.

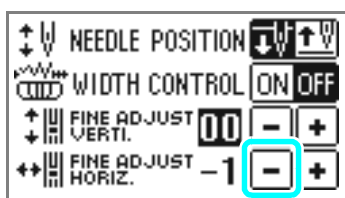

8 Press **[↶]** (Back key).

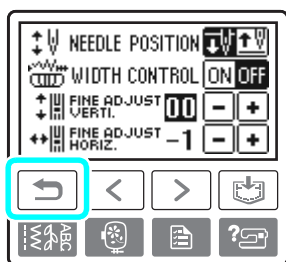

▶ It returns to the screen for adjusting the pattern.

9 Select **[O]** once again, start the sewing machine and check the stitching.

Continue adjusting the pattern until it is sewn correctly.

Designing a Pattern (My Custom Stitch)

With the My Custom Stitch function, you can sew stitch patterns that you design yourself.

Drawing a sketch of the pattern

Prepare a grid sheet set.

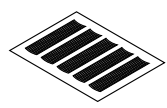

1 Draw a sketch of the pattern on the grid sheet set.

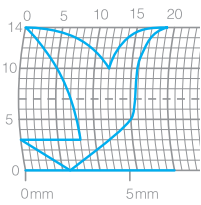

Draw the pattern as one continuous line and with the start point and the end point of the design at the same height.



2 If the pattern will be repeated, determine the space between the repeating patterns.

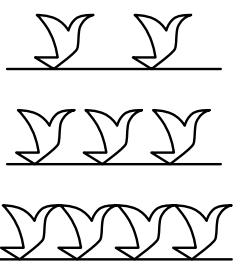
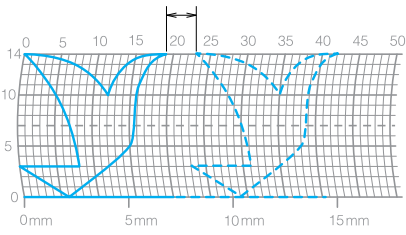

3 Mark the points in the pattern that are positioned at intersections in the grid, and then link those points with a continuous straight line.

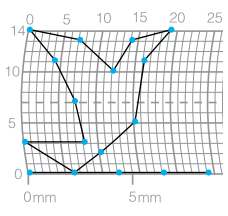

4 Determine the sewing order.

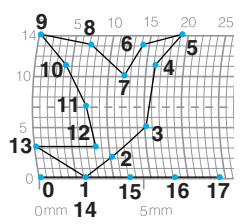

For a more attractive stitch, close the pattern by intersecting the line.

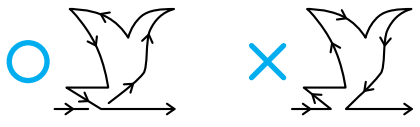

Entering the pattern data

Follow the pattern drawn on the grid sheet and program the pattern into the sewing machine.

- 1 Attach monogramming foot "N".

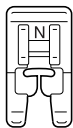

- For details, refer to "Replacing the presser foot" (page 44).

- 2 Press (Utility stitch key) on the operation panel, and select .

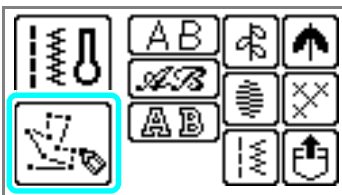

▶ The screen for entering a pattern appears.

- 3 Check the grid sheet set, and specify the coordinates of the first point. Specify the coordinates using and press .

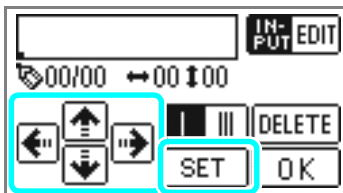

- 4 Specify whether single stitching or triple stitching will be sewn between the points. is single stitching, and gives triple stitching.

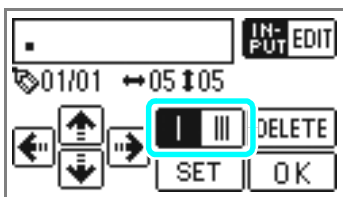

- 5 Specify the coordinates of the second point, and then press .

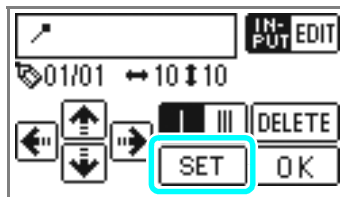

- 6 Repeat steps 4 through 5 to specify each point.

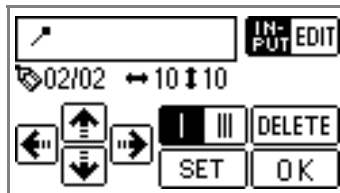

- If you make a mistake entering a point, press , and the previous point is erased.
- To correct the content entered, press . You can insert, delete and move points.

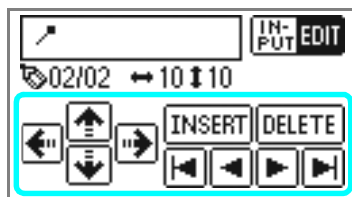

- 7 After all points have been entered, press .

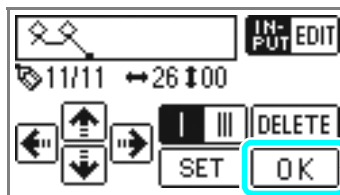

▶ The sewing screen appears.

- 8 Specify the various stitching settings, such as reverse/reinforcement stitching, in the same way as with other stitches.

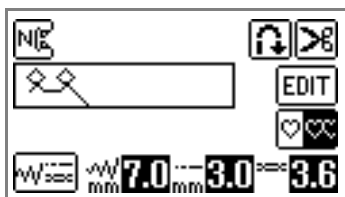

- To revise the pattern, press **EDIT**.



Memo

- The pattern you entered can be saved for later use. For details, refer to “Saving patterns” (page 135).

Examples of designs

Enter each of the points indicated in the table to sew the sample stitch.

					
Point	↔	↑↓	Point	↔	↑↓
1	0	0	21	38	13
2	12	0	22	35	14
3	18	3	23	32	13
4	22	6	24	30	10
5	23	10	25	32	6
6	21	13	26	35	3
7	17	14	27	41	0
8	14	13	28	45	0
9	12	11	29	47	4
10	9	13	30	44	7
11	6	14	31	45	11
12	3	13	32	47	13
13	1	10	33	50	14
14	3	6	34	54	13
15	6	3	35	56	10
16	12	0	36	55	6
17	41	0	37	51	3
18	43	4	38	45	0
19	40	7	39	70	0
20	41	11			

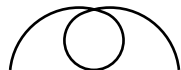
					
Point	↔	↑↓	Point	↔	↑↓
1	0	0	21	16	10
2	3	5	22	18	12
3	5	8	23	21	13
4	8	11	24	25	14
5	12	13	25	28	14
6	17	14	26	33	13
7	20	14	27	37	11
8	24	13	28	41	8
9	27	12	29	43	5
10	29	11	30	44	0
11	31	9			
12	32	6			
13	30	3			
14	27	1			
15	24	0			
16	21	0			
17	18	1			
18	16	3			
19	15	5			
20	15	8			

					
Point	↔	↑↓	Point	↔	↑↓
1	0	0	21	10	11
2	30	0	22	12	10
3	32	1	23	8	9
4	32	7	24	12	8
5	32	10	25	7	6
6	33	12	26	12	6
7	35	11	27	6	3
8	35	8	28	10	2
9	37	12	29	5	0
10	35	14	30	10	2
11	32	14	31	16	1
12	30	11	32	19	0
13	30	5	33	23	0
14	29	3	34	22	6
15	26	8	35	17	10
16	24	10	36	22	6
17	18	13	37	23	0
18	13	14	38	19	0
19	12	14	39	42	0
20	13	12			

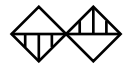
					
Point	↔	↑↓	Point	↔	↑↓
1	0	7	21	20	11
2	5	7	22	21	7
3	4	3	23	24	7
4	5	7	24	23	14
5	8	7	25	24	7
6	7	0	26	27	7
7	8	7	27	27	11
8	11	7	28	27	7
9	11	3	29	32	7
10	11	7	30	27	11
11	16	7	31	23	14
12	11	3	32	20	11
13	7	0	33	16	7
14	4	3	34	20	3
15	0	7	35	23	0
16	4	11	36	27	3
17	7	14	37	32	7
18	11	11			
19	16	7			
20	21	7			

4

EMBROIDERY

The steps for embroidering are described in this chapter.

Successful Embroidering.....	144	Selecting Embroidery Patterns.....	159
What to prepare.....	144	Copyright information.....	159
Embroidery step by step	146	Embroidery pattern types	159
Attaching the Embroidery Foot.....	147	LCD (liquid crystal display)	
Attaching the embroidery foot	147	operation	160
Removing the embroidery foot.....	149	Selecting an embroidery pattern ...	162
Attaching the Embroidery Unit.....	150	Selecting characters	163
Embroidery unit precautions	150	Selecting a frame pattern	164
Attaching the embroidery unit	150	Using an embroidery card	
Removing the embroidery unit.....	152	(sold separately)	165
Preparing the Fabric	153	Embroidering.....	166
Attaching an optional stabilizer		Sewing attractive finishes	166
material to the fabric	153	Embroidering a pattern.....	167
Setting the fabric		Appliquéing	169
in the embroidery frame	154	Editing Patterns	171
Attaching the Embroidery Frame.....	157	Adjusting the layout	171
Attaching the embroidery frame ...	157	Adjusting the thread tension.....	173
Removing the embroidery frame ...	158	Adjusting the alternate bobbin case	
		(with no color on the screw)	174
		Resewing	175
		Thread runs out partway	
		through a design.....	175
		Stopping while embroidering	176
		Using the Memory Function.....	178
		Embroidery data precautions.....	178
		Saving patterns	180
		Transferring embroidery patterns	
		from the computer to machine.....	181

Successful Embroidering

This section describes the preparations and basic procedures for embroidering.

What to prepare

The following is necessary for embroidering.

■ Fabric

Prepare the fabric for embroidery. Prepare a piece of fabric a little larger than the embroidery frame that matches the size of the pattern you want to sew.



Note

- Always use stabilizer when sewing embroidery projects, especially when embroidering on lightweight or stretch fabrics. Not using a stabilizer may result in poor quality embroidery designs.
- When embroidering on large pieces of fabric, arrange the fabric so that it does not hang off the table where the sewing machine is placed. If embroidery is done with the fabric hanging off, the embroidery unit movement may be impaired, this could cause the pattern to sew incorrectly.



CAUTION

- Do not embroider fabrics that are too thick. To check the fabric thickness, attach the embroidery frame to the embroidery unit, and use  (“Needle Position” button) to raise the needle. If there is space between the presser foot and the fabric, the fabric can be embroidered. If there is not space, do not embroider the fabric. Otherwise, the needle may break, resulting in injury.
- Be careful when sewing overlapping patterns. The needle may not easily pierce the fabric, causing the needle to break.

■ Stabilizer material

Attach a stabilizer material for embroidery to the fabric to prevent poor quality embroidery designs.



We recommend stabilizer material for embroidery. Use a water soluble sheet on thin materials like organza and fabrics with a nap like towels. For details, refer to “Optional accessories” (page 12).

■ Embroidery thread

For the upper thread, use the embroidery thread or country thread.

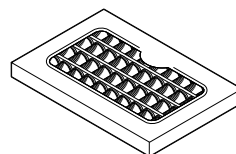

For the bobbin thread, use the embroidery bobbin thread. For details, refer to “Optional accessories” (page 12).



Note

- For good quality embroidery designs be sure to use embroidery thread designed for embroidery machines.
- Before starting to sew, be sure there is enough bobbin thread. If you continue embroidering when the bobbin thread is low, the thread may become tangled.

■ Needle

Use a 75/11 home sewing machine needle. When embroidering on thick fabrics such as denim, use a 90/14 home sewing machine needle.



Memo

- A 75/11 needle is already installed when the sewing machine is purchased.
- When replacing the needle, refer to “Replacing the needle” (page 42).



CAUTION

- **Since ball point needles (gold colored) are needles for fabrics where stitches are easily skipped, such as pattern stitching and stretch fabrics, be absolutely sure not to use them for embroidery. The needle may break or bend.**

■ Other

Embroidery frames “small” and “medium” are optional. For details, refer to “Optional accessories” (page 12).

Embroidery step by step

The basic steps for embroidery are as follows.

1	Presser foot attachment	Attach the embroidery foot "Q". For details on attaching the embroidery foot, refer to "Attaching the embroidery foot" (page 147).
↓		
2	Checking the needle	Use a needle matched to the fabric. For details on replacing the needle, refer to "Replacing the needle" (page 42).
↓		
3	Embroidery unit attachment	Attach the embroidery unit. For details on attaching the embroidery unit, refer to "Attaching the embroidery unit" (page 150).
↓		
4	Replacing the bobbin case	When using other kinds of embroidery bobbin thread, use the optional alternate bobbin case (no color on the screw). For details on replacing the bobbin case, refer to "Cleaning the race" (page 184).
↓		
5	Bobbin thread setup	For the bobbin thread, wind embroidery bobbin thread and set it in place. For details on setting up the bobbin thread, refer to "Winding/Installing the Bobbin" (page 25).
↓		
6	Fabric preparation	Attach a stabilizer material to the fabric, and hoop it in an embroidery frame. For details on preparing the fabric, refer to "Preparing the Fabric" (page 153).
↓		
7	Embroidery frame attachment	Attach the embroidery frame to the embroidery unit. For details on attaching the embroidery frame, refer to "Attaching the Embroidery Frame" (page 157).
↓		
8	Pattern selection	Select an embroidery pattern. For details on selecting embroidery patterns, refer to "Selecting Embroidery Patterns" (page 159).
↓		
9	Checking the layout	Check and adjust the size and position of the embroidery. For details on adjusting the layout, refer to "Adjusting the layout" (page 171).
↓		
10	Embroidery thread setup	Set up embroidery thread according to the pattern. For details on setting up the thread, refer to "Upper Threading" (page 31).

Attaching the Embroidery Foot

This section describes how to attach the embroidery foot.

Attaching the embroidery foot

Attach the embroidery foot when embroidering. Have the included embroidery foot “Q” and a screwdriver ready.

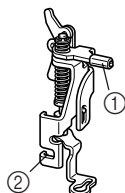

- ① Embroidery foot bar
- ② Caught by the presser foot holder screw

CAUTION

- Always use the embroidery foot “Q” when embroidering. If the wrong presser foot is used, the needle may hit the presser foot and break or bend.

- 1 Press  (“Needle Position” button) once or twice to raise the needle.

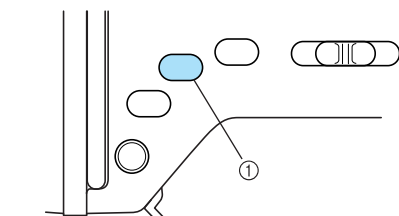

- ① “Needle Position” button
- ▶ The needle goes up.

- 2 Turn off the sewing machine.

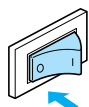

CAUTION

- Before replacing the presser foot, be sure to turn off the sewing machine, otherwise injuries may occur if  (“Start/Stop” button) is accidentally pressed and the machine starts sewing.

- 3 Raise the presser foot lever.

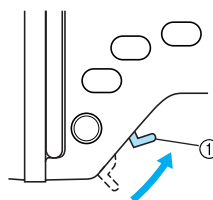

- ① Presser foot lever
- ▶ The presser foot is raised.
- At the time of purchase, the presser foot lever is up.

- 4 Press and hold the black button on the back of the presser foot holder to detach the presser foot.

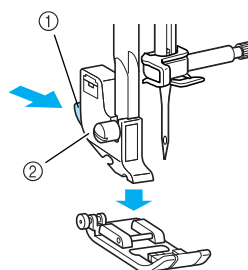

- ① Black button
- ② Presser foot holder

5 Loosen the presser foot holder screw and remove the presser foot holder.

Turn the screwdriver toward the back.

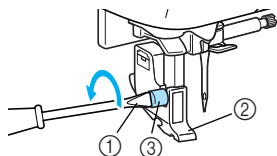

- ① Screwdriver
- ② Presser foot holder
- ③ Presser foot holder screw

6 Hold the embroidery foot with your right hand, as shown.

Hold the embroidery foot with your index finger wrapped around the lever at the back of the foot.

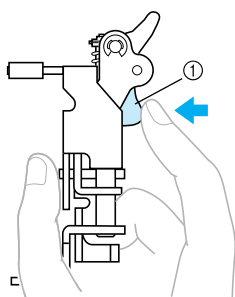

- ① Lever

7 While pressing in the lever with your finger, fit the embroidery foot bar over the needle clamp screw to attach the embroidery foot to the presser foot bar.

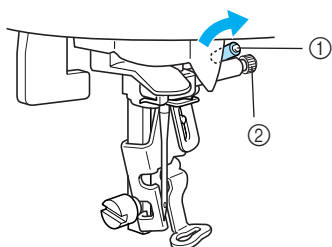

- ① Embroidery foot bar
- ② Needle clamp screw

8 Secure the embroidery foot with the presser foot holder screw.

Set the embroidery foot perpendicular.

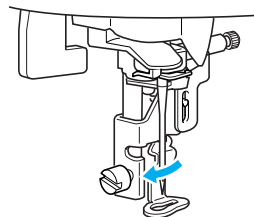

9 Firmly tighten the presser foot holder screw.

Turn the screwdriver toward the front.

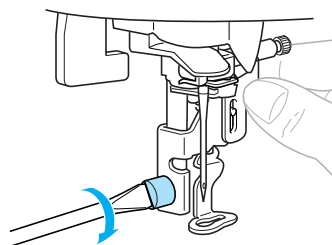

! CAUTION

- Do not hit the needle with your finger or the embroidery foot “Q” when attaching it. The needle may break or cause injury.
- Be sure to tighten the screw with the included screwdriver. If the screw is loose, the needle may hit the presser foot and break or bend.
- Before sewing, always turn the handwheel toward you (counterclockwise) slowly to make sure that the needle does not hit the presser foot. Otherwise, the needle may break or bend.

Removing the embroidery foot

- 1 Press  (“Needle Position” button) once or twice to raise the needle.

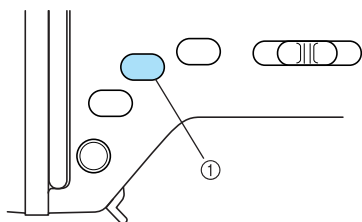

① “Needle Position” button

- 2 Turn off the sewing machine.

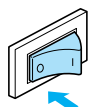

- 3 Raise the presser foot lever.

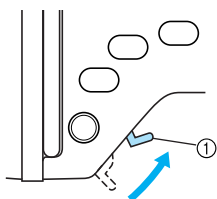

① Presser foot lever

▶ The presser foot is raised.

- 4 While pressing in the lever at the back of the embroidery foot with your finger, loosen the presser foot holder screw, and then remove embroidery foot “Q”.

Turn the screwdriver toward the back.

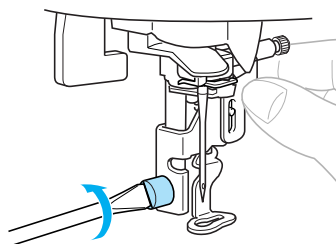

- 5 Attach the presser foot holder.

- For details, refer to “Attaching the presser foot holder” (page 46).

Attaching the Embroidery Unit

This section describes how to attach the embroidery unit.

Embroidery unit precautions

Cautions for the embroidery unit will be explained below.

CAUTION

- Do not move the sewing machine with the embroidery unit in place. The embroidery unit may be dropped and cause injury.
- Keep your hands and other objects away from the embroidery carriage and frame. Otherwise injury may result.



Note

- Do not touch the connector in the embroidery unit connector slot. The connector could be damaged, and it may cause malfunctions.
- Do not lift up on the embroidery carriage, and do not forcefully move it. It may cause malfunctions.

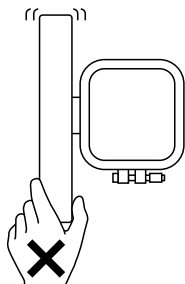

Attaching the embroidery unit

Get the included embroidery unit ready.

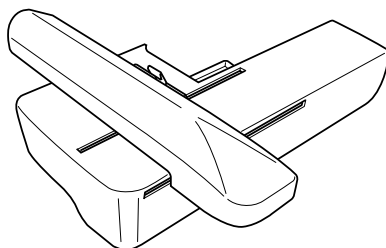

- 1 Turn off the sewing machine.

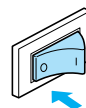

- 2 Pull the flat bed attachment off to the left.

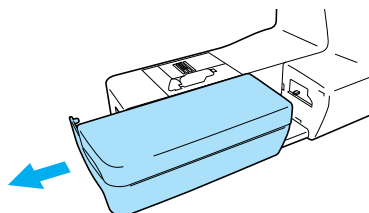

- 3 Slide the tab on the cover of the connection port in the direction of the arrow to open the cover.

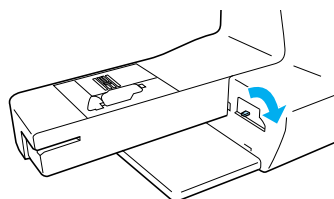

Note

- Be sure to close the cover of the connection port when the embroidery unit is not being used.

- 4** Slide the embroidery unit onto the sewing machine arm.
Push it in until it clicks and stops.

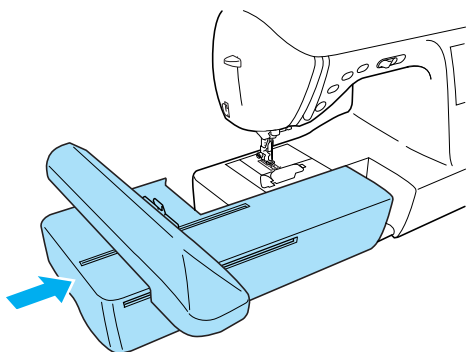

- ▶ The embroidery unit is attached.

- 5** Turn on the sewing machine.

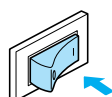

- ▶ The confirmation message is displayed.

- 6** Be sure that no objects or hands are near the embroidery unit and press **OK**.

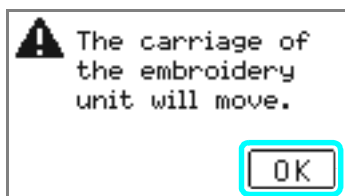

- When an animation is displayed on the screen, the message above will be displayed if you touch the screen with your finger.
- ▶ The carriage moves to its initial position.

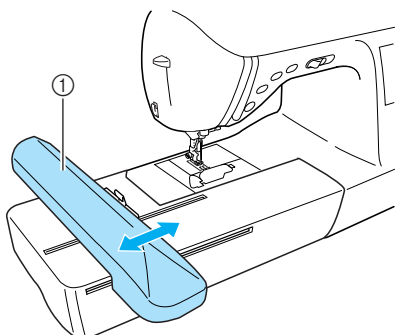

① Carriage

CAUTION

- Do not put your hands or other objects near the carriage. It may cause injury.

Note

- If the machine is initialized with hands or objects near the carriage, the screen may return to the initial display. After removing whatever is near the carriage, turn the power on again.

- ▶ The screen for selecting the embroidery pattern type is displayed.

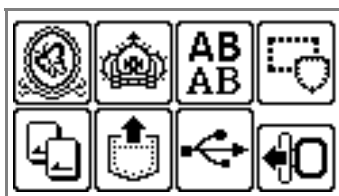

- For details on the embroidery patterns, refer to "Selecting Embroidery Patterns" (page 159).

Memo

- Utility stitches cannot be selected when the embroidery unit is attached.

Removing the embroidery unit

Make sure that the sewing machine is completely stopped and follow the instructions below.

1 Remove the embroidery frame.

- For details on removing the embroidery frame, refer to "Removing the embroidery frame" (page 158).

2 Press , and then press .

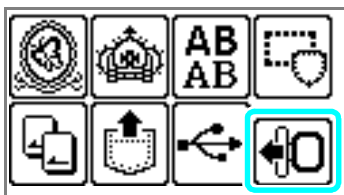

- The embroidery carriage moves into a position where it can be stored.

3 Turn off the sewing machine.

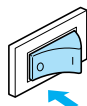

CAUTION

- Always turn off the sewing machine before removing the embroidery unit. It may cause malfunctions if removed when the machine is turned on.

4 Hold the release button on the bottom left of the embroidery unit, and slowly pull the embroidery unit to the left.

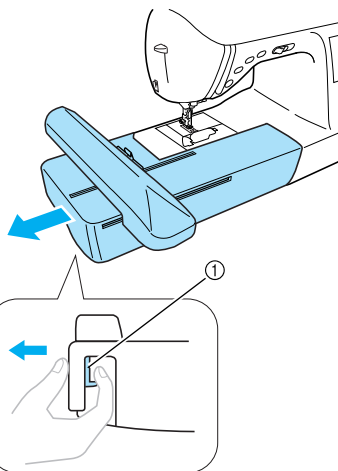

① Release button

- The embroidery unit separates from the sewing machine.

CAUTION

- Do not carry the embroidery unit by holding the release button compartment.

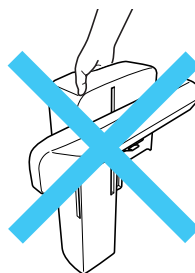

Preparing the Fabric

After attaching a stabilizer material to the embroidery fabric, it is stretched on an embroidery frame.

Attaching an optional stabilizer material to the fabric

Attach a stabilizer material for embroidery to the fabric to prevent poor quality embroidery designs.

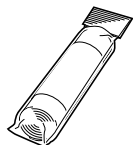

Memo

- We recommend the stabilizer material for embroidery. Use a water soluble stabilizer on thin materials like organdy and fabrics with a nap like towels. For details, refer to "Optional accessories" (page 12).

Note

- Always use stabilizer material for embroidery with stretch fabrics, thin fabrics, fabrics with a loose weave and fabrics where stitches easily contract.

CAUTION

- Always use stabilizer material when sewing embroidery projects. The needle may break or bend if you embroider without using a stabilizer material for thin fabrics or stretch fabrics. Furthermore, the pattern may be sewn incorrectly.

- 1 Prepare stabilizer material that is larger than the embroidery frame being used.

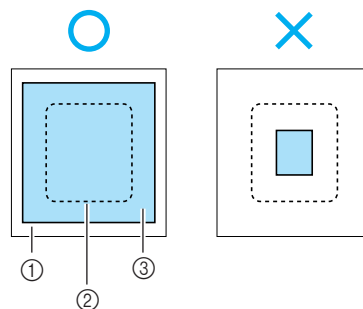

- ① Fabric
- ② Size of embroidery frame
- ③ Stabilizer material

- 2 If you are using stabilizers with adhesive, place the adhesive surface of the stabilizer material against the wrong side of the fabric, and iron it with a steam iron.

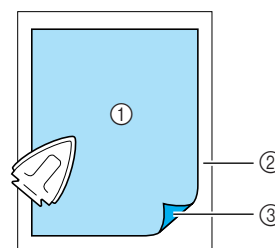

- ① Stabilizer material
- ② Fabric (wrong side)
- ③ Attached surface

- When it cannot be ironed or placed in the hoop.

For fabrics, such as towels, which cannot be ironed or for embroidering in places where ironing is difficult, place the stabilizer material under the fabric, and stretch the fabric in the embroidery frame without attaching the stabilizer.

Setting the fabric in the embroidery frame

The fabric is stretched in the embroidery frame. If the fabric is loose, the quality of the embroidery pattern may be poor. Put the fabric in the frame without slack following the steps below. Have a fabric with a stabilizer material attached and the embroidery frame (medium, small, large or extra large (multi-position)) ready.

■ Embroidery frame (large)

Embroidery can be done in an area with a height of up to 18 cm (7 inches) and a width of up to 13 cm (5 inches). This is used to embroider multiple patterns without changing the fabric position in the frame.

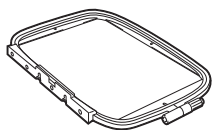

■ Embroidery frame (medium)[option]

Patterns with a height of up to 10 cm (4 inches) and a width of up to 10 cm (4 inches) can be sewn.

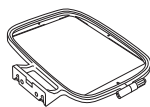

■ Embroidery frame (small)[option]

Patterns with a height of up to 2 cm (1 inch) and a width of up to 6 cm (2-1/2 inches) can be sewn. This is used for letters and other small embroidery.

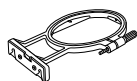

- There are patterns for which embroidery frame (small) cannot be used.

■ Embroidery frame (extra large (multi-position))

Embroidery can be done in an area with a height of up to 30 cm (12 inches) and a width of up to 13 cm (5 inches). This is used to embroider connected or combined characters or patterns, or large patterns.

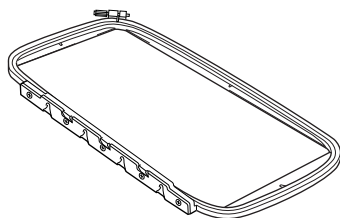

! CAUTION

- Use the embroidery frame that matches the size of the pattern being embroidered. Otherwise, the embroidery frame may be hit by the presser foot and cause injury or needle breakage.

- 1 Loosen the embroidery frame adjustment screw and remove the inner and outer frames, placing the outer frame on a flat surface. Separate the inner and outer frame by removing inner frame upward.

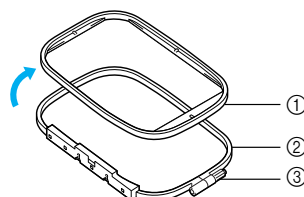

- ① Inner frame
- ② Outer frame
- ③ Adjustment screw

- 2 Place the fabric with the stabilizer material on top of the outer frame.

Have the right side of the cloth up.

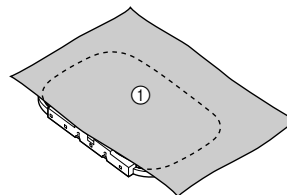

- ① Right side

- 3 Press the inner frame in from the top of the fabric.

Line up \triangle on the inner frame and ∇ on outer frame.

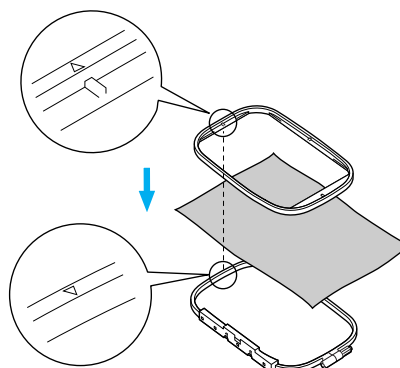

- 4 Tighten the adjustment screw by hand just enough to secure the fabric.

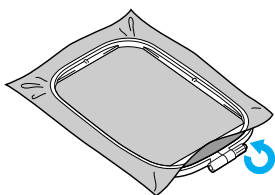

- 5 Gently remove the fabric from the frame without loosening the adjustment screw.

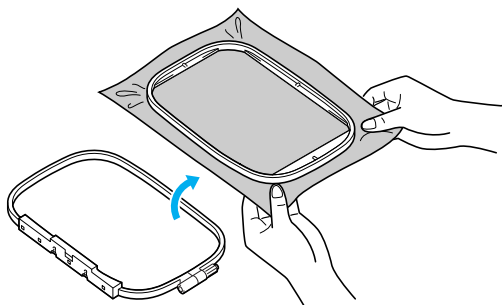

Memo

- This precautionary step will help reduce pattern distortion while embroidering.

- 6 Press the inner frame in from the top of the fabric again, lining up \triangle on the inner frame and ∇ on outer frame.

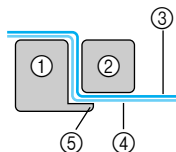
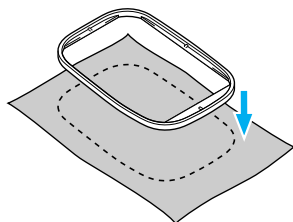

- ① Outer frame
- ② Inner frame
- ③ Fabric (right side)
- ④ Stabilizer material
- ⑤ Ledge of outer frame

- Press down firmly until the inner frame is securely pressed against the ledge of the outer frame.

- 7 Tighten the adjustment screw while removing any slack in the fabric by hand. The goal is to have a drum-like sound when the stretched fabric is struck lightly.

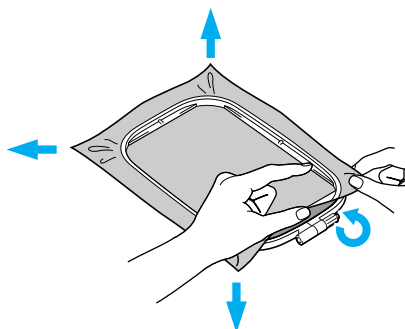

■ Using embroidery sheets

If the embroidery sheet attached to the embroidery frame is used, the embroidery can be sewn in exactly the right position on the fabric.

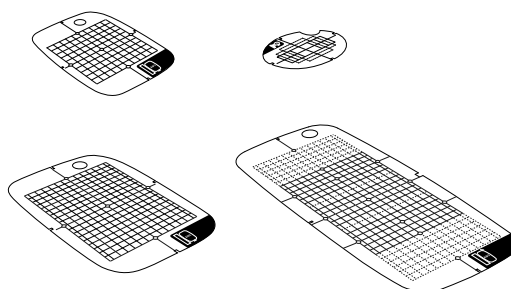

- ① Make a mark with a chalk pen at the center of the position for the pattern to be embroidered.

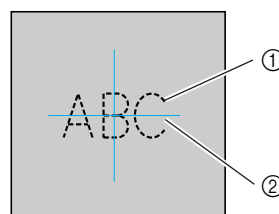

- ① Embroidery pattern
- ② Mark

- ② Place the embroidery sheet on the inner frame.

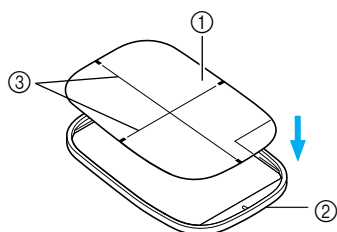

- ① Embroidery sheet
- ② Inner frame
- ③ Embroidery sheet base lines

- ③ Line the mark on the fabric up with the base line on the embroidery sheet.

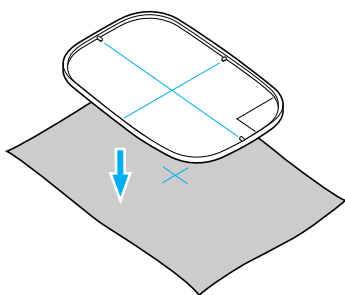

- ④ Place the inner frame with the fabric on the outer frame and stretch the fabric.

- For details, refer to page 154.

- ⑤ Remove the embroidery sheet.

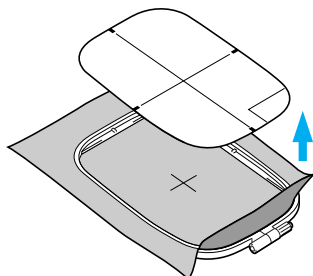

■ Embroidery on fabrics that cannot be stretched on an embroidery frame

When small pieces of fabric that cannot be stretched on an embroidery frame or thin pieces like ribbon are being embroidered, use stabilizer material as a base to stretch on the frame. We recommend stabilizer material for all embroidery.

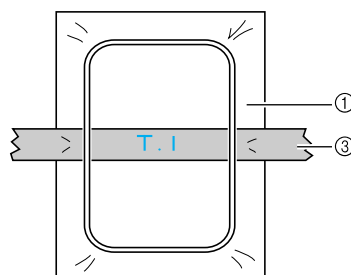
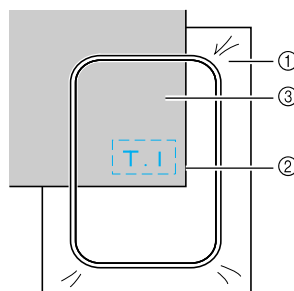
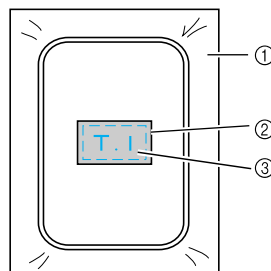

- ① Stabilizer material
- ② Tack or spray glue
- ③ Fabric

After completing the embroidery, remove the stabilizer material carefully.

Attaching the Embroidery Frame

This section describes how to attach the embroidery frame.

Attaching the embroidery frame

- 1 Wind the embroidery bobbin thread onto the bobbin and set it into the bobbin case.

- For details, refer to “Winding/Installing the Bobbin” (page 25).

- 2 Raise the presser foot lever.

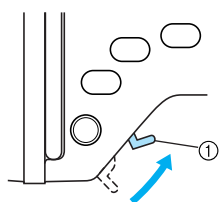

- ① Presser foot lever

- 3 Pass the embroidery frame under the presser foot while raising the presser foot lever even further.

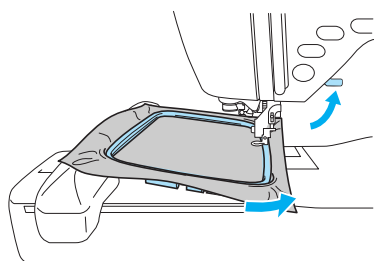

CAUTION

- Do not hit the needle with your finger or the embroidery frame. It may cause injury or needle breakage.

- 4 While lightly holding the lever on the frame holder to the left, align the two pins on the embroidery frame holder with the mounting brackets on the frame, and then press the frame into the embroidery frame holder until a click is heard.

After pressing the front mounting bracket onto the pin so that it clicks into place, press the back mounting bracket into place.

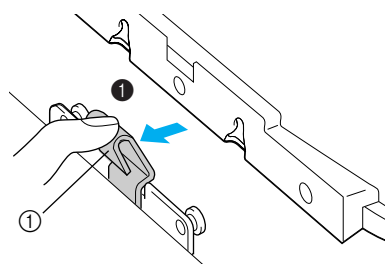

- ① Lever

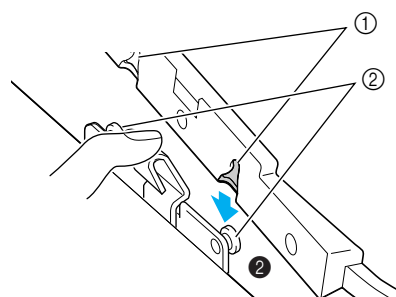

- ① Mounting brackets
② Pins

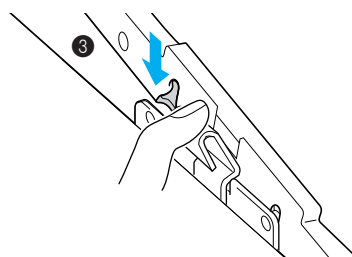

Note

- Be sure to insert both pins. If only the forward or the back pin is inserted, the pattern may not turn out correctly.

CAUTION

- Correctly set the embroidery frame into the embroidery frame holder. Otherwise, the presser foot may hit the embroidery frame, resulting in injury.

Removing the embroidery frame

Make sure that the sewing machine is completely stopped and follow the instructions below.

- 1 Raise the presser foot lever.

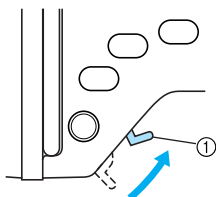

① Presser foot lever

- 2 While pushing the lever of the embroidery frame holder to the left, lift the embroidery frame up to remove it.

Remove the back mounting bracket from the pin, and then remove the front mounting bracket from the pin.

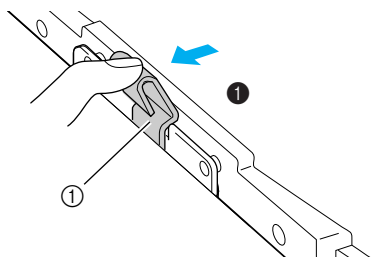

① Lever

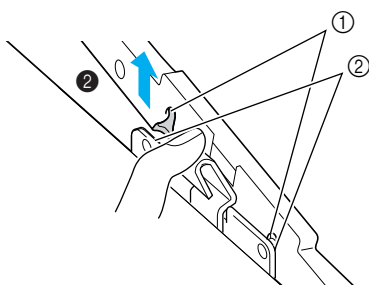

① Mounting brackets
② Pins

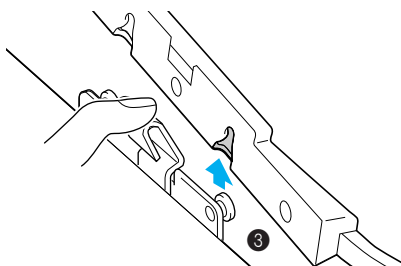

- 3 Pass the embroidery frame under the presser foot while raising the presser foot lever even further.

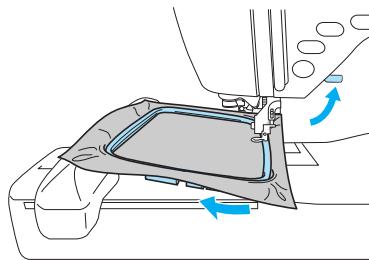

! CAUTION

- Do not hit the needle with your finger or the embroidery frame. It may cause injury or needle breakage.

Selecting Embroidery Patterns

This section provides details on the various types of embroidery patterns available and the procedure for selecting a pattern.

Copyright information

The patterns saved in the sewing machine and embroidery cards are intended for private use only. Any public or commercial use of copyrighted patterns is an infringement of copyright law and is strictly prohibited.

Embroidery pattern types

An embroidery pattern can be selected from the following types available.

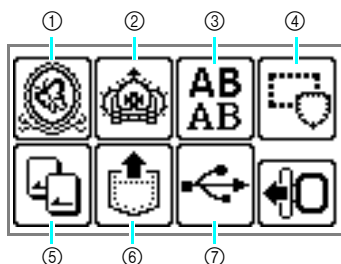

- ① Embroidery patterns
- ② Additional embroidery patterns
- ③ Alphabet patterns
- ④ Frame patterns
- ⑤ Embroidery card
- ⑥ Patterns saved in the machine's memory
- ⑦ Patterns retrieved from a USB flash drive (USB flash memory)

■ Embroidery patterns (Embroidery patterns/Additional embroidery patterns)

There are total 136 patterns. The patterns are completed by changing the upper thread according to the instructions displayed on the screen.

- For details, refer to “Selecting an embroidery pattern” (page 162).

■ Alphabet patterns

There are 6 types of characters (European characters); upper case/lower case/numbers/symbols.

- For details, refer to “Selecting characters” (page 163).

■ Frame patterns

10 shapes, such as squares and circles, can be combined with 12 stitch types.

- For details, refer to “Selecting a frame pattern” (page 164).

■ Embroidery card (sold separately)

Patterns from an embroidery card can be embroidered.

- For details, refer to “Using an embroidery card (sold separately)” (page 165).

■ Patterns saved in the machine's memory

Patterns, such as frequently used character combinations, can be saved in the machine's memory to be retrieved later and embroidered. Patterns consisting of up to 12 patterns or 512 KB can be saved.

- For details, refer to “Saving patterns” (page 180).

■ Patterns retrieved from a USB flash drive (USB flash memory)

Patterns retrieved from USB media can be embroidered.



Note





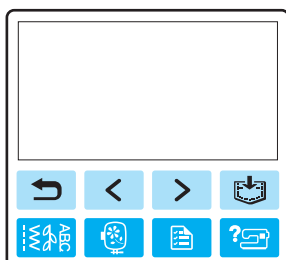

- Only a USB flash drive (USB flash memory) can be connected to the USB port on this machine.
- For details, refer to “Transferring embroidery patterns from the computer to machine” (page 181).

LCD (liquid crystal display) operation

The LCD (liquid crystal display) is operated using the operation keys on the operation panel. The use of the keys for embroidery will be explained below.

■ Operation keys



-  Returns to the previous screen.
-  When there are patterns that are not displayed on the screen (when  or  is displayed), the previous patterns/subsequent patterns are displayed.
-  Returns to the type selection screen. The selected pattern is cancelled.
-  Press this key to adjust language or change the thread color display or other settings.

Press  (Settings key).

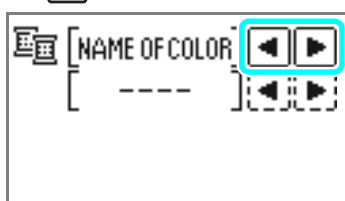

NAME OF COLOR: Typical color name

TIME: Time required for embroidering

NEEDLE COUNT: Needle progress number

#123: Select from the following thread color number sets

- EMBROIDERY (POLYESTER) THREAD#
- COUNTRY (COTTON) THREAD#
- MADEIRA POLY THREAD#
- MADEIRA RAYON THREAD#
- SULKY THREAD#
- ROBISON-ANTON POLY THREAD#

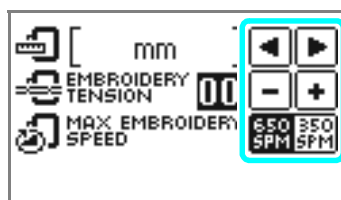

DISPLAY UNIT

The measurement units that are displayed can be selected. [mm/inch]

EMBROIDERY TENSION

The thread tension for embroidering can be adjusted. [-8 to +8]

MAX EMBROIDERY SPEED (SPM)

The maximum embroidering speed can be selected. [650SPM/350SPM]

■ LCD button



CHECK When a specific pattern is selected, press this key and then, press to switch the display. The sewing settings such as the specified alphabet character string and color are confirmed.

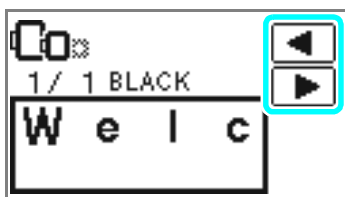

Press this key to change the thread settings.



- Press this key to select or cancel programmed thread cutting.
- Press or to adjust the thread tension.
- Press or to change the thread density (character patterns only).

AD-JUST Press this key to adjust the pattern.



MULTI-COLOR Press this key when you want to change the color character by character in character embroidery. Since the sewing machine stops at the end of each character, the upper thread is changed as you sew. Press this key again to cancel multi-color.

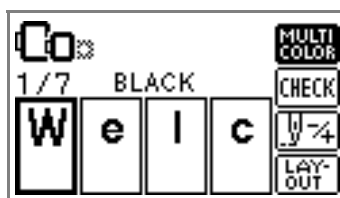

The needle progresses one color or one stitch (if pressed continuously, 9 stitches to 20 stitches) at a time and changes the position for starting the embroidery. This is used when a specific color is not sewn or when restarting the sewing machine after power has been turned off in the middle of the operation.

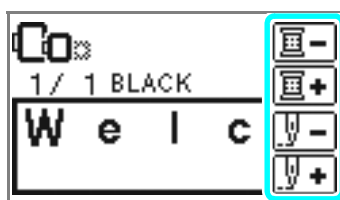

- Back one color
- Forward one color
- Back one stitch
- Forward one stitch

• For details, refer to “Resewing” (page 175).

LAY-OUT The position of the pattern within the embroidery frame can be checked, and the size and angle can be changed.

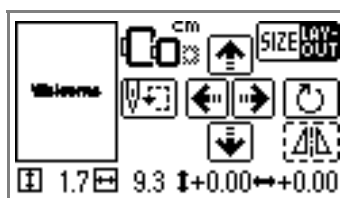

• For details, refer to “Adjusting the layout” (page 171).

Memo

- Keys that appear surrounded with a dotted line cannot be used.

Selecting an embroidery pattern

There are total of 136 embroidery patterns, such as fruits and animals, saved in the machine's memory.



70 Embroidery patterns



66 Embroidery patterns



Memo

- Refer to “Embroidery Pattern Color Change Table” in the Quick reference guide for samples of completed patterns and the thread used.

1 Select the type of the embroidery pattern.

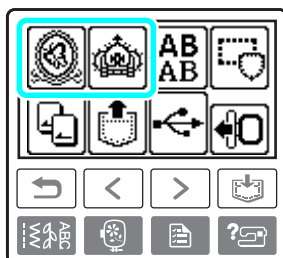

- ▶ The pattern selection screen is displayed.

2 Select the pattern.

Switch the screen using (Previous page key) and (Next page key).



- When / is pressed, the display of patterns moves forward or backward in increments of 10 designs.

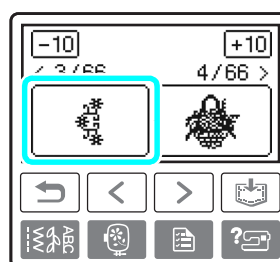

- ▶ When a pattern is selected, it can be embroidered.



Selecting characters

Specify the characters for embroidery.



Memo

- When “The pattern is too large for the embroidery frame.” is displayed, no more characters can be input.
- Characters of different styles (sans serif, serif, and outline, etc.) cannot be combined.

1 Select the character stitches.



2 Select the character style.

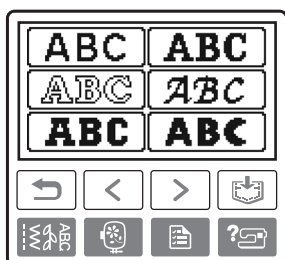

3 Select the characters.

- If a wrong character was selected, press **DELETE**.
- To enter a space, press “_”.

□ Example: Welcome



Switch between uppercase/lowercase



Switch among large/medium/small sizes

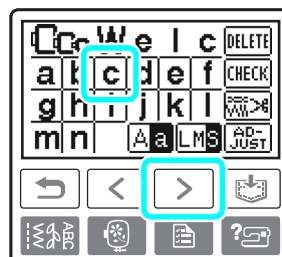
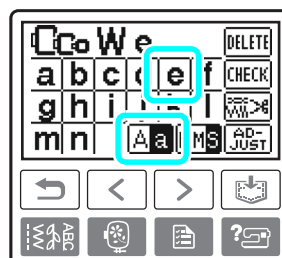

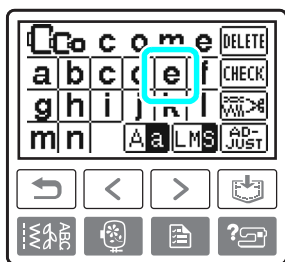

Memo

- The character pattern that you created can be saved for later use. For details, refer to “Saving patterns” (page 180).

Selecting a frame pattern

10 shapes, such as squares and circles, can be combined with 12 stitch types.

Memo

- Refer to “Frame patterns” in the Quick reference guide for frame pattern shapes and stitches.

1 Press the frame pattern.

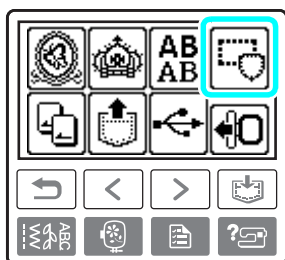

- ▶ The frame shape selection screen is displayed.

2 Select the frame shape.

Switch the screen using (Previous page key) (Next page key), and select from the ten types.

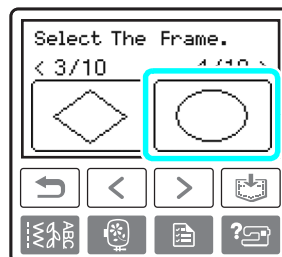
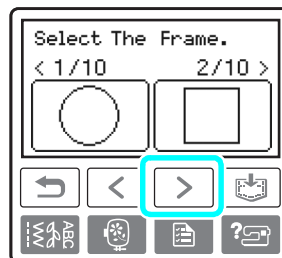

- ▶ The stitch selection screen is displayed.

3 Select the stitch.

Switch the screen using (Previous page key) (Next page key), and select from the 12 stitches.

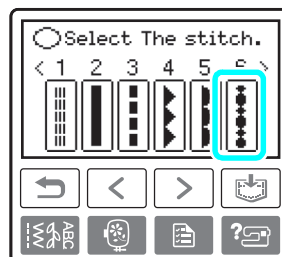

- ▶ When a stitch is selected, it can be embroidered.

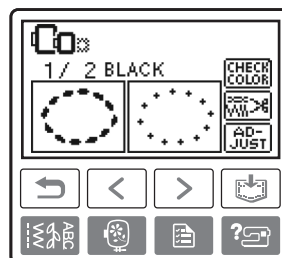

Using an embroidery card (sold separately)

If an embroidery card is used, you can embroider patterns other than the patterns saved in the sewing machine. There are various cards with different themes.



Note

- Always turn off the sewing machine to insert and remove embroidery cards.
- Insert the embroidery card into the embroidery card slot, facing it in the right direction.
- Do not put anything other than an embroidery card in the embroidery card slot.
- When embroidery cards are not in use, keep them in their storage cases.
- Use only embroidery cards manufactured for this machine. Using unauthorized cards may cause your machine to operate incorrectly.
- Embroidery cards purchased in foreign countries may not work with your machine.
- Large patterns supplied on embroidery cards may be difficult to view on the screen.

1 Turn off the sewing machine.

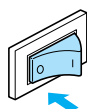

2 Insert the embroidery card in the embroidery card slot on the right side of the sewing machine.

Face the arrow on the embroidery card toward you, and insert it in the direction of the arrow.

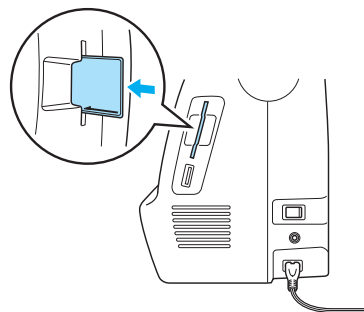

3 Turn on the sewing machine.

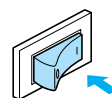

4 Press the embroidery card on the screen.

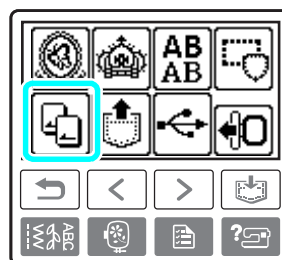

▶ The selection screen for the patterns saved in the card is displayed.

5 Select a pattern.

The operation is the same as in "Selecting Embroidery Patterns" (page 159).



Embroidering

After the preparations are done, you can try embroidering. This section describes the steps for embroidering and appliquéing.

Sewing attractive finishes

There are many factors that go into sewing beautiful embroidery. Using the appropriate stabilizer (page 153) and hooping the fabric in the frame (page 154) are two important factors mentioned earlier. Another important point is the appropriateness of the needle and thread being used. See the explanation of threads below. Included with this machine are two bobbin cases. Follow the explanation below.

Thread	Upper thread	Use embroidery thread, or country embroidery thread intended for use with this machine. Other embroidery threads may not yield optimum results.
	Bobbin thread	Use embroidery bobbin thread intended for use with this machine.



Memo

- If you use threads other than those listed above, the embroidery may not sew out correctly.

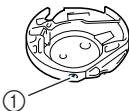
Bobbin case  ① Standard bobbin case (green marking on the screw) Alternate bobbin case (no color on the screw)	Standard bobbin case (green marking on the screw) is in the machine for sewing and embroidery. The bobbin case originally installed in the machine has a green screw.
	Alternate bobbin case (no color on the screw) is set with tighter tension for embroidery with different weights of bobbin threads and a variety of embroidery techniques. This bobbin case is identified with a dark colored mark on the inside of the bobbin cavity. The screw on this case can be adjusted if necessary.

- For details on how to remove the bobbin case, refer to “Cleaning the race” (page 184).
- For details on adjusting the alternate bobbin case, refer to “Adjusting the alternate bobbin case (with no color on the screw)” (page 174).



Note

- Before embroidering, check that there is enough thread in the bobbin. If you continue sewing without enough thread in the bobbin, the thread may tangle.
- Do not leave objects in the range of motion of the embroidery frame. The frame may strike the object and cause a poor finish to the embroidery pattern.
- When embroidering on large garments (especially jackets or other heavy fabrics), do not let the fabric hang over the table. Otherwise, the embroidery unit cannot move freely, and the pattern may not turn out as planned.

Embroidering a pattern

Embroidery patterns are embroidered with a change of thread after each color.

- 1 Prepare embroidery thread of the color shown on the screen.

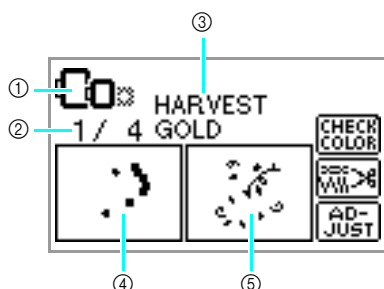

- 1 Embroidery frames that can be used for embroidering
 - 2 Current color step/Number of colors in design
 - 3 Current name of color
 - 4 Current color part
 - 5 Next color part
- The thread color number set displayed for the thread colors can be changed. Press  (Settings key), and then change the setting in the settings screen. For details, refer to "LCD (liquid crystal display) operation" (page 160).

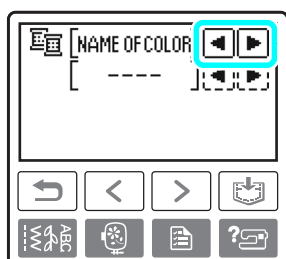

- Example: Embroidery thread number selected

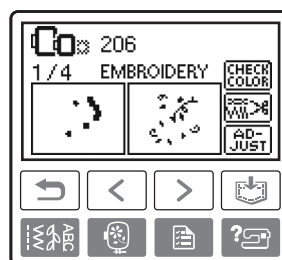
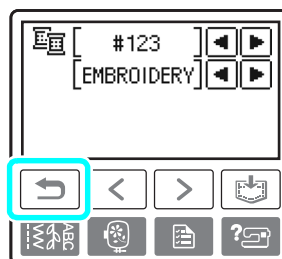

- 2 Set the embroidery thread, and thread the needle.

- Refer to "Threading the upper thread" (page 32) and "Threading the needle" (page 34).

Note

- Before using the needle threader, be sure to lower the presser foot.

- 3 Pass the thread through the embroidery foot hole, and hold it lightly in your left hand.

Give the thread a little slack.

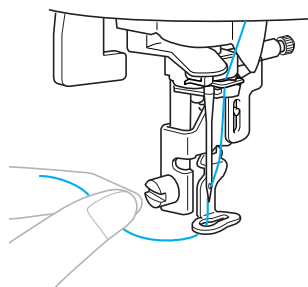

CAUTION

- If the thread is pulled too tight, the needle may break or bend.
- Do not let hands or objects hit the carriage while sewing. The pattern may misalign.

4 Lower the presser foot lever.

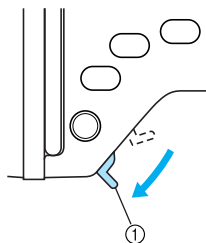

① Presser foot lever

5 Press (“Start/Stop” button).

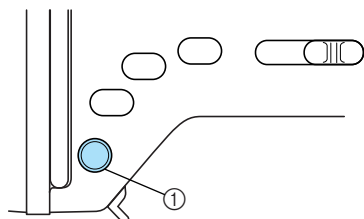

① “Start/Stop” button

6 After progressing 5-6 stitches, press (“Start/Stop” button) to stop the machine.

7 Use scissors to cut the thread at the beginning of the stitching.

Cut the thread at the edge of the stitching.

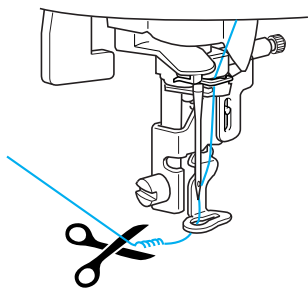

- If the thread is left at the beginning of the stitching, it may be sewn over as you continue embroidering the pattern, making it very difficult to deal with the thread after the pattern is finished. Trim the thread at the beginning.

8 Press (“Start/Stop” button) again.

- ▶ The embroidery begins again.
- ▶ Stitching stops automatically with reinforcement after one color has been completed. When automatic thread cutting is set, the thread is cut.

9 Set up embroidery thread for the next color, and repeat steps 1 through 8.

10 Cut the excess thread.

- ▶ When the last color is sewn, “Finished sewing.” will appear on the display. Press , and the display will return to the initial screen.



Memo

- For the automatic cutting setting, refer to “LCD (liquid crystal display) operation” (page 160).

Appliquéing

Prepare the base fabric and the appliqué fabric (appliqué piece). Press  (Settings key), and set the thread color display to NAME OF COLOR, so "APPLIQUE MATERIAL", "APPLIQUE POSITION" and "APPLIQUE" are displayed on the screen.

1 Select an appliqué pattern.

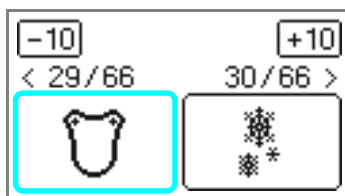

2 When "APPLIQUE MATERIAL" is displayed on the screen, apply iron-on stabilizer to the back of the appliqué piece fabric, and stretch it on the embroidery frame.

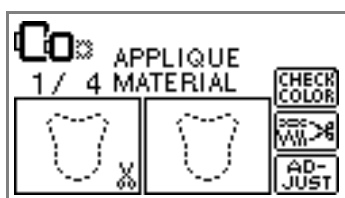

3 Lower the presser foot lever, and press ("Start/Stop" button).

- ▶ The cut-out for the appliqué piece is sewn, and the sewing machine stops.

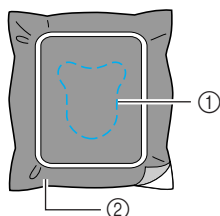

- ① Cut-out line
- ② Appliqué piece fabric

- ▶ "APPLIQUE POSITION" will be displayed on the screen.



4 Remove the fabric from the embroidery frame, and cut it out along the cut-out line. Cut carefully along the stitching and remove the thread.

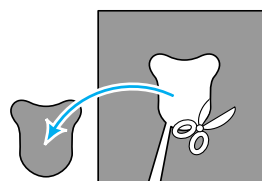

- If it is not cut right on the stitching, it will not be finished neatly.

5 Stretch the base fabric on the embroidery frame.

6 Set up the thread for appliquéing.

7 Lower the presser foot lever, and press ("Start/Stop" button).

- ▶ The position for the appliqué is stitched, and the sewing machine stops.

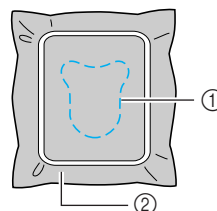



- ① Appliqué position
- ② Base fabric

- ▶ "APPLIQUE" will be displayed on the screen.

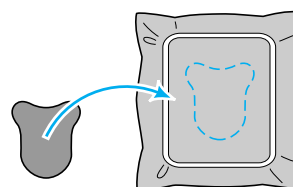

8 Apply a thin layer of fabric glue or spray adhesive to the back of the appliqué piece, and attach it in the appliqué position.



- 9 Lower the presser foot lever, and press  (“Start/Stop” button).

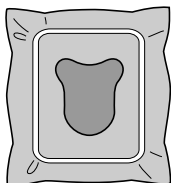

Note

- When “APPLIQUE MATERIAL”, “APPLIQUE POSITION” and “APPLIQUE” are displayed, a specific color thread does not appear. Use a proper color thread to match the appliqué piece.

- 10 Follow the instructions on the screen, and change thread colors as you sew.

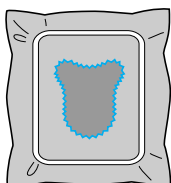
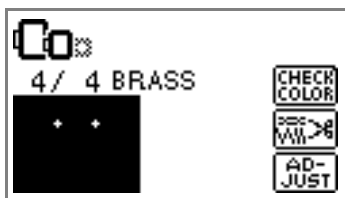

Editing Patterns

This section describes ways to edit, adjust, and reposition patterns.

Adjusting the layout

The pattern is normally positioned in the center of the embroidery frame. You can check the layout before starting embroidery and change the position and the size.



Memo

- Keys that appear surrounded with a dotted line cannot be used.

1 After selecting the embroidery pattern, press

ADJUST

- ▶ The embroidery screen is displayed.



2 Press

LAYOUT



- ▶ The layout screen is displayed.

3 Check and adjust the layout.

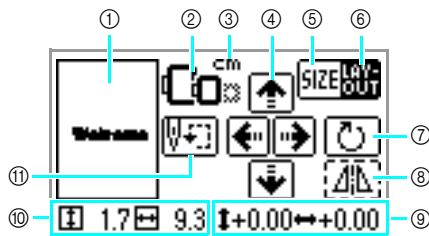

- ① Layout within the frame
- ② Available embroidery frames
- ③ Display unit (cm/INCH)
- ④ Change position keys
- ⑤ Size key
- ⑥ Layout key
- ⑦ Rotation key
- ⑧ Horizontal mirror image key
- ⑨ Distance from the center
- ⑩ Embroidery size
- ⑪ Starting point key



Embroidery frame size

These flash if the pattern was resized, the layout was adjusted, or the recommended embroidery frame size was changed. Embroidery frame icons that appear in gray cannot be used.



Size key

Increases/decreases the size of the pattern. Press **LAYOUT** to return to the previous screen.

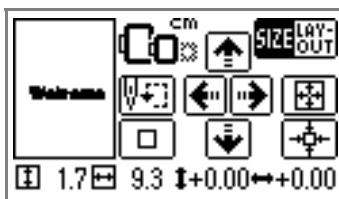

Decreases size



Returns to original size
Returns to center position (when the pattern was moved with the change position key)



Increases size



Change position keys

Moves the embroidery position up, down, left and right.



Memo

- If you make a note of the values in the lower part of screen when you change the size and position, you can sew with the same size and layout even if you have to turn the power back on in the middle of your work.



Layout key

Press this key to move to rotation screen.

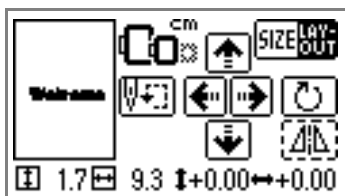

Rotation key

Rotates the pattern one degree, 10 degrees or 90 degrees at a time.

- Press (Back key) to return to the previous screen.

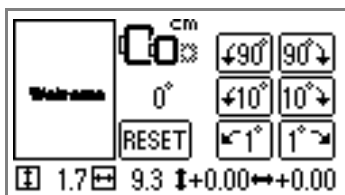

Rotates the pattern 90 degrees to the left



Rotates the pattern 90 degrees to the right



Rotates the pattern 10 degrees to the left



Rotates the pattern 10 degrees to the right



Rotates the pattern 1 degree to the left



Rotates the pattern 1 degree to the right



Returns the pattern to its original position



Horizontal mirror image key

Mirrors the pattern left and right.



Starting point key

Press this key to move the embroidery frame and check the embroidering position or to change the needle position before embroidering.

The screen below appears when this key is pressed.

- Press to return to the previous screen.

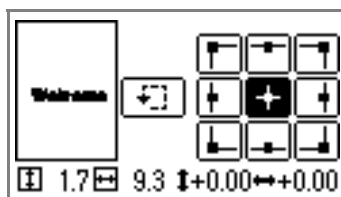

Moves the needle to the position of the selected needle start position.



Moves the frame to check the pattern position.

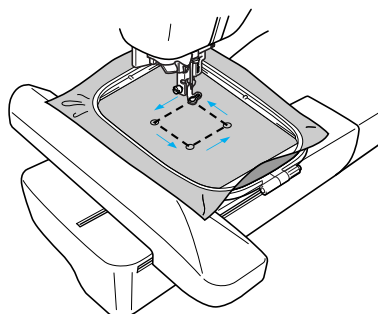

CAUTION

- **Never lower the needle when the embroidery frame is moving. The needle may break or bend.**
- **When you have revised the pattern, check the display of available embroidery frames and use an appropriate frame. If you use an embroidery frame not displayed as available for use, the presser foot may strike the frame and possibly cause injury.**

- 4 Press  (Back key) to return to the original screen.

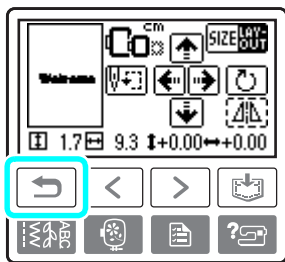

Memo

- When the power is turned off, the layout returns to the original setting.
- You can also check the pattern size and distance from the center by pressing  after beginning embroidering.

Adjusting the thread tension

If embroidery fails, it is difficult to undo the thread and the fabric may be damaged. Before embroidering, use a scrap of the same fabric to check the adjustment of the thread tension, etc.

To adjust the thread tension, press  (Settings key).



Press  to weaken the thread tension.

Press  to tighten the thread tension.

■ Correct thread tension

The thread tension is correct when upper thread is just visible on back of the fabric.



- ① Right side
- ② Wrong side

■ Upper thread is too tight

The lower thread will be visible on the front of the fabric. In this instance, decrease the upper thread tension.



- ① Right side
- ② Wrong side

■ Upper thread is too loose

The upper thread has slack. In this instance, increase the upper thread tension.

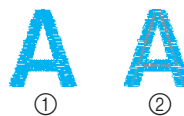

- ① Right side
- ② Wrong side

Adjusting the alternate bobbin case (with no color on the screw)

When using the embroidery bobbin thread provided, please be sure to choose the green marked bobbin case when performing utility stitch sewing and embroidery functions. When in the embroidery function mode, the alternate bobbin case (with no color on the screw) should be selected when substitute embroidery bobbin threads (other than what is accompanied with your machine) are being used. The alternate bobbin case (with no color on the screw) can be easily adjusted when bobbin tension changes are required to accommodate different bobbin threads. Refer to "Sewing attractive finishes" (page 166).

To adjust the bobbin tension for embroidery function, using the alternate bobbin case (with no color on the screw), turn the slotted screw (-) with a (small) screwdriver.

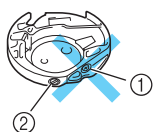

- ① Do not turn a phillips screw (+).
- ② Adjust with a screwdriver (small).

■ Correct tension

Upper thread slightly appears on the wrong side of fabric.



- ① Right side
- ② Wrong side

■ Bobbin thread is too loose

Bobbin thread appears slightly on the right side of fabric.



- ① Right side
- ② Wrong side

If this occurs, turn the slotted screw (-) clockwise, being careful not to over-tighten the screw, approximately 30-45 degrees to increase bobbin tension.

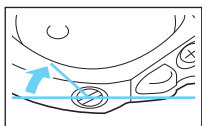

■ Bobbin thread is too tight

Upper thread on the right side of fabric seems to be lifting/looping and bobbin thread is not seen on the wrong side of fabric.



- ① Right side
- ② Wrong side

If this occurs, turn the slotted screw (-) counterclockwise, being careful not to over-loosen the screw, approximately 30-45 degrees to decrease bobbin tension.

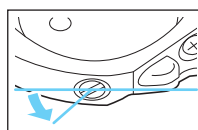







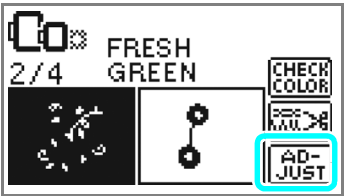

! CAUTION

- When adjusting the alternate bobbin case, be sure to remove the bobbin from the alternate bobbin case.
- DO NOT adjust the position of the phillips (+) screw on the alternate bobbin case as this may result in damage to the bobbin case, rendering it unusable.
- If the slotted screw (-) is difficult to turn, do not use force. Turning the screw too much or providing force in either (rotational) direction may cause damage to the bobbin case. Should damage occur, the bobbin case may not maintain proper tension.







Resewing

When the wrong upper thread color has been sewn, it can be resewn with the correct color.

- 1 Press  ("Start/Stop" button) to stop the sewing machine.
 - 2 Press .
- 
- 3 Press .
- 
- 4 Press  (Back one color) to return to the beginning of the mistaken color.
- 
- 5 Set up the correct color for the upper thread.
 - 6 Press  ("Start/Stop" button) to continue the design.

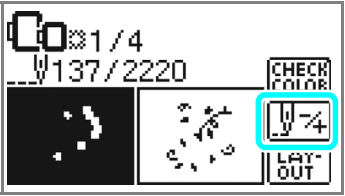
Thread runs out partway through a design

When the upper thread or the bobbin thread runs out while sewing, the sewing machine stops. Move the needle back about 10 stitches and resume sewing.

- 1 Set up the upper or bobbin thread.
 - 2 Press .
- 
- 3 Press .
- 
- 4 Press  (Back one stitch) to move the needle back about 10 stitches.
 (Forward one stitch) increases the stitch number.
- 
- 5 Restart the embroidery.
- 

Stopping while embroidering

If the embroidery is stopped before it is complete, check the current needle count before turning off the sewing machine.



Memo

- When the sewing machine is turned off, the embroidery size and layout return to the original setting.

1 Press (“Start/Stop” button) to stop the sewing machine.

2 Check the current needle count on the screen and make a note of it.

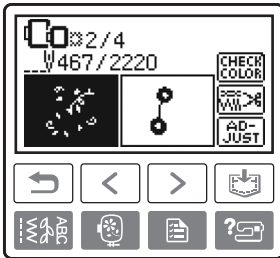

If the needle count is not displayed, press (Settings key), and then use to display the following screen.

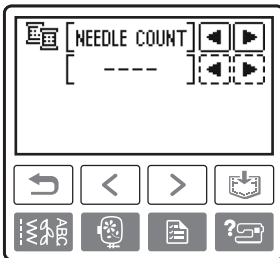

Press (Back key) to return to the embroidery screen.

3 Press (Embroidery key).



▶ The confirmation message is displayed.

4 Press .



▶ The selected pattern is deleted, and the screen for selecting the embroidery pattern type is displayed.

5 Turn off the sewing machine.

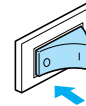

- Always detach the embroidery unit when you move the sewing machine.

6 Turn on the sewing machine and select the pattern.

7 Press .





8 Press .

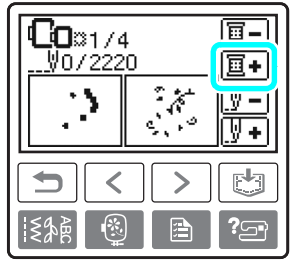

9 Press  (Forward one color) to move to the beginning of the color you want to embroider.



10 Press  (Forward one stitch) to increase the needle count.
If  is pressed continuously, it moves forward 1 → 9 → 30 stitches.

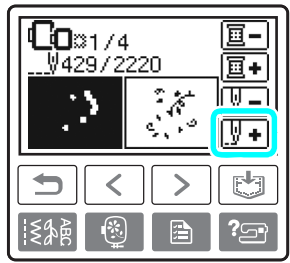

Move forward to about 10 stitches before the total number of stitches confirmed in .

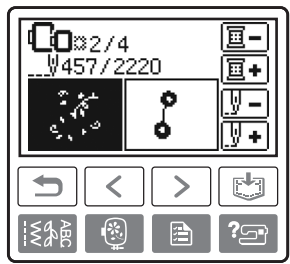

11 Restart the embroidery.

Using the Memory Function

Embroidery data precautions

Observe the following precautions when using embroidery data other than that created and saved in this machine.

CAUTION

- **When using embroidery data other than our original patterns, the thread or needle may break when sewing with a stitch density that is too fine or when sewing three or more overlapping stitches. In that case, use one of our original data design systems to edit the embroidery data.**

■ Types of Embroidery Data That Can Be Used

- Only .pes and .dst embroidery data files can be used with this machine. Using data other than that saved using our data design systems or sewing machines may cause the embroidery machine to malfunction.

■ Types of USB Media That Can Be Used

Embroidery data can be recalled from a USB flash drive (USB flash memory) of any size.



Note

- Only a USB flash drive (USB flash memory) can be connected to the USB port on this machine.
- Some USB media may not be compatible with this machine. Visit our website for more details.
- When using USB media equipped with an access indicator, the access indicator will begin flashing after the media is inserted into your computer or machine, and may take about 5 to 6 seconds before the media is recognized. (The length of time differs depending on the USB media.)
- For additional information, refer to the instruction manual included with the USB media that you have purchased.



Memo

- Letters and numerals can be used in file names. In addition, if the file name contains no more than eight characters, the entire file name will appear on the screen. If the file name is more than eight characters long, only the first six characters followed by “~” and a number appear as the file name. This applies to .dst embroidery data files only.
- Only the names of .dst files are displayed.

■ Precautions on Using the Computer To Create and Save Data

- If the file name of embroidery data cannot be identified, for example, because the name contains special characters, the file will not be displayed. If this occurs, change the name of the file. We recommend using the 26 letters of the alphabet (uppercase and lowercase), the numbers 0 through 9, “-”, and “_”.
- All designs must be within the 18 cm (H) × 13 cm (W) (Approx. 7 inches (H) × 5 inches (W)) design field size. If the selected pattern does not fit within the 18 cm (H) × 13 cm (W) (Approx. 7 inches (H) × 5 inches (W)) design field size unless it is rotated 90 degrees, a message appears, asking if you wish to rotate the pattern 90 degrees.
- .pes files saved with the number of stitches, the number of colors and the number of combined patterns exceeding the specified limits cannot be displayed. Use one of our original data design systems to edit the embroidery pattern so that it meets the required specifications.
- Even if the embroidery unit is not attached, the machine will recognize embroidery data.
- Save the patterns in the root directory of the USB media. If embroidery data is saved in a folder on USB media, that embroidery data cannot be retrieved by the machine.

■ Tajima (.dst) Embroidery Data

- When a .dst file is imported, the only way that you can view the design is by selecting the pattern (file name).
Then press  to display the design on the screen.

Saving patterns

The embroidery patterns and the alphabet characters you have customized can be saved in the sewing machine's memory.

Since the saved patterns will not be erased when the power is turned off, you can always retrieve them for embroidery. This is convenient for saving names and the like. You can save up to 12 patterns or 512 KB of data.

■ Saving a pattern

① After selecting the pattern to be saved, press

 (Memory key).



▶ After the pattern is saved, the initial screen appears again.



Note

- Do not turn off the sewing machine while the pattern is being saved, otherwise the pattern data may be lost.

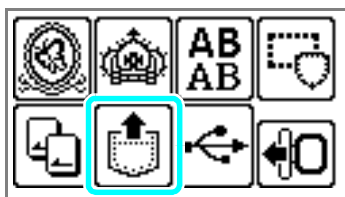

■ Retrieving a pattern.

① Press .



▶ The saved patterns are displayed.

② Select the pattern you wish to retrieve.

Switch screens using  (Previous page key) and  (Next page key).



- ① Total amount of memory used
- ② Total amount of memory space
- ③ Number of the currently displayed page from the total number of pages

▶ The selected pattern is shown in reverse highlighting.

③ Press .

To delete the saved pattern, press .



▶ The saved pattern is retrieved.

▶ The embroidery screen appears, and you can embroider the retrieved pattern.

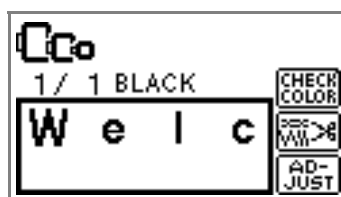

Note

- Characters saved from an embroidery card must have the embroidery card inserted in the machine in order to retrieve the memory saved from the embroidery card.

Transferring embroidery patterns from the computer to machine



Note

- Only a USB flash drive (USB flash memory) can be connected to the USB port on this machine.
- An embroidery pattern can be transferred to the machine from USB media containing data for no more than 200 embroidery patterns.
- Embroidery patterns cannot be transferred to the machine if the USB media contains data for more than 200 embroidery patterns. In this case, reduce the number of designs saved on the USB media.
- In addition, if the embroidery designs contain too many colors (this number may vary within the designs themselves), it may not be possible to transfer an embroidery pattern to the machine, even if there are less than 200 embroidery patterns that have been saved on the USB media. In this case also, reduce the number of designs saved on the USB media.
- Save the patterns in the root directory of the USB media. If embroidery data is saved in a folder on USB media, that embroidery data cannot be retrieved by the machine.

- 1 Insert the USB media into the USB port on the computer.

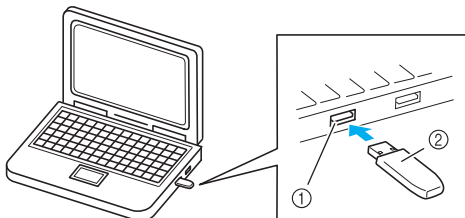

- 1 USB port on the computer
- 2 USB media

- 2 The "Removable Disk" icon appears in "Computer (My computer)" on the computer.

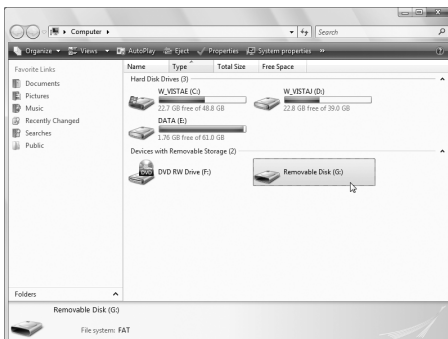

- 3 Copy the pattern data to "Removable Disk".

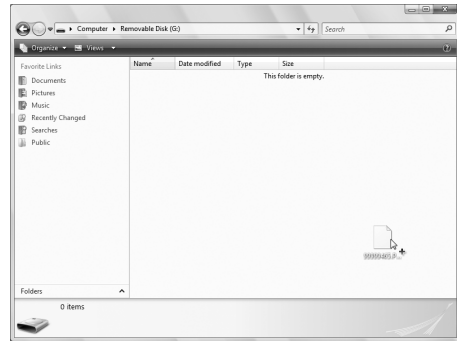

- 4 Safely remove the USB media from the USB port on the computer.

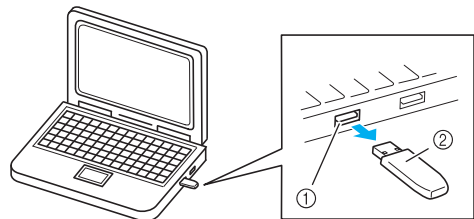

- 1 USB port on the computer
- 2 USB media

CAUTION

- Before disconnecting the USB media, click the "Unplug or Eject Hardware" icon in the taskbar of Windows® 2000 or the "Safely Remove Hardware" icon in the taskbar of Windows® XP/Windows Vista®. Then, when the removable disk can safely be removed, disconnect the USB media from the computer.

Windows® XP



Windows Vista®



5 Insert the USB media into the USB port on the machine.

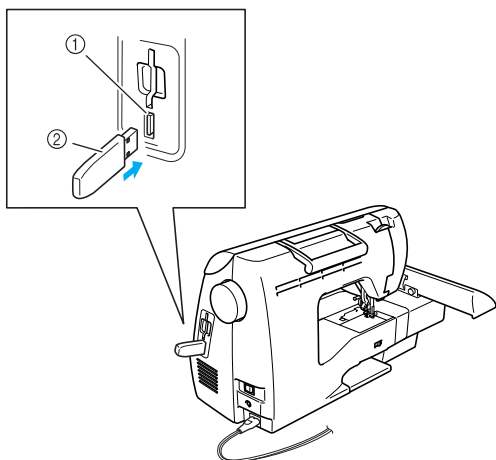

- ① USB port
(for a USB flash drive (USB flash memory))
- ② USB media

6 Press .

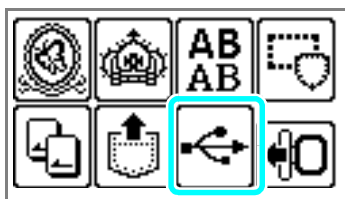

▶ The saved patterns are displayed.



Note

- If the message “Reduce the number of patterns.” appears, the USB media may contain either more than 200 embroidery patterns or the embroidery designs may contain too many colors (although there may be no more than 200 patterns).

In this case, unplug the USB media from the machine, plug it back into the computer, and then delete a few designs at a time from the USB media.



Close the error message on the machine, and then repeat procedures starting from step 5.



Memo

- The pattern file names appear in alphabetical order.
- Only the names of .dst files are displayed.

7 Select the pattern you wish to retrieve.

Switch screens using  (Previous page key) and  (Next page key).

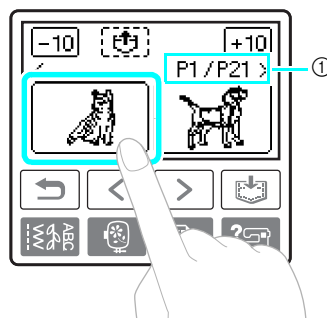

- ① Number of the currently displayed page from the total number of pages

- When  is pressed, the display of patterns moves forward or backward in increments of 10 designs.

▶ The selected pattern is shown in reverse highlighting.

8 Press .



▶ The saved pattern is retrieved.

▶ The embroidery screen appears, and you can embroider the retrieved pattern.

9 Adjust the pattern as desired, and then begin embroidering.





5

APPENDIX

The various maintenance and troubleshooting procedures are described in this chapter.

- Care and Maintenance 184
 - Cleaning the machine surface 184
 - Cleaning the race 184
- Troubleshooting 186
 - Error messages 191
 - Adjusting the LCD 194
 - Operation beep 194
 - Canceling the operation beep 195
- Upgrading Your Machine’s Software Using USB Media 196
- Index 197

Care and Maintenance

Simple sewing machine maintenance operations are described below.

Cleaning the machine surface

If the surface of the machine is dirty, lightly soak a cloth in neutral detergent, squeeze it out firmly, and then wipe the surface of the machine. After cleaning it once with a damp cloth, wipe it again with a dry cloth.

CAUTION

- Unplug the power cord before cleaning the machine, otherwise injuries or an electric shock may occur.

Cleaning the race

Sewing performance will suffer if dust collects in the bobbin case, therefore, it should be cleaned periodically.

- 1 Turn off the sewing machine.

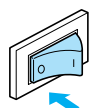

- 2 Unplug the power cord from the power supply jack on the right side of the sewing machine.

CAUTION

- Unplug the power cord before cleaning the machine, otherwise injuries or an electric shock may occur.

- 3 Remove the flat bed attachment or the embroidery unit if either is attached.

- 4 Grasp both sides of the needle plate cover, and then slide it toward you.

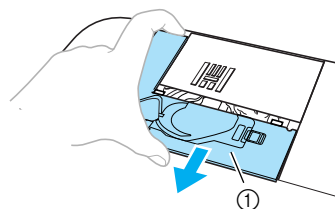

- ① Needle plate cover
- ▶ The needle plate cover is removed.

- 5 Remove the bobbin case. Grasp the bobbin case, and then pull it out.

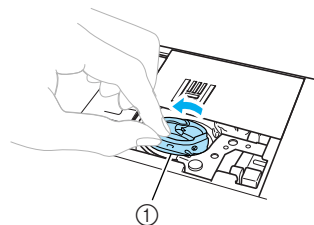

- ① Bobbin case

- 6 Use the cleaning brush or a vacuum cleaner to remove any lint and dust from the race and its surrounding area.

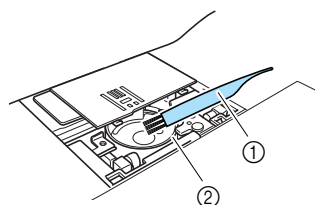

- ① Cleaning brush
- ② Race
- Do not apply oil to the bobbin case.

- 7** Insert the bobbin case so that the projection on the bobbin case aligns with the spring.

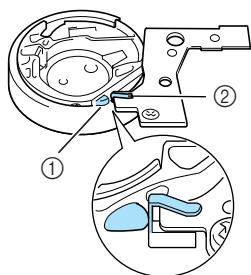
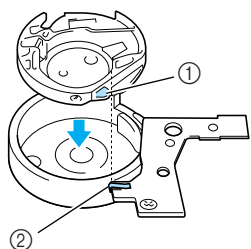

- ① Projection
② Spring

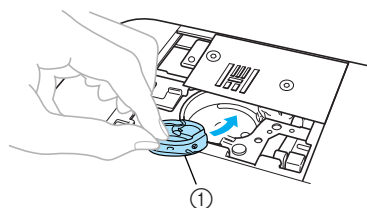

- ① Bobbin case

- 8** Insert the tabs on the needle plate cover into the needle plate, and then slide the cover back on.

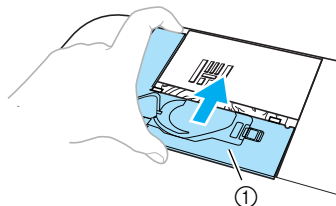

- ① Needle plate cover

! CAUTION

- Never use a bobbin case that is scratched, otherwise the upper thread may become tangled, the needle may break or sewing performance may suffer. For a new bobbin case (part code: XC3153-221 (green marking), XC8167-451 (no color on the screw)), contact your nearest authorized service center.
- Be sure that the bobbin case is correctly installed, otherwise the needle may break.

Troubleshooting

If the machine stops operating correctly, check the following possible problems before requesting service. If the problem persists, contact your retailer or the nearest authorized service center.

Symptom	Probable Cause	Remedy	Reference
The sewing machine does not operate.	The machine is not turned on.	Turn on the machine.	page 19
	The “Start/Stop” button was not pressed.	Press the “Start/Stop” button.	page 53
	The presser foot lever is raised.	Lower the presser foot lever.	page 52
	The “Start/Stop” button was pressed, even though the foot controller is connected.	Do not use the “Start/Stop” button when the foot controller is connected. To use the “Start/Stop” button, disconnect the foot controller.	page 53
The needle breaks.	The needle is incorrectly installed.	Correctly install the needle.	page 42
	The needle clamp screw is loose.	Use the screwdriver to firmly tighten the screw.	
	The needle is bent or blunt.	Replace the needle.	
	The combination of fabric, thread and needle is not correct.	Select a thread and needle that are appropriate for the type of fabric being sewn.	page 41
	The presser foot that is used is not appropriate for the type of stitch that you wish to sew.	Attach the presser foot that is appropriate for the type of stitch that you wish to sew.	page 70
	The upper thread tension is too tight.	Loosen the upper thread tension.	page 59
	The fabric is pulled too much.	Lightly guide the fabric.	–
	The spool is incorrectly installed.	Correctly install the spool.	page 31
	The area around the hole in the needle plate is scratched, or has a burr on it.	Replace the needle plate. Contact your retailer or the nearest authorized service center.	–
	The area around the hole in the presser foot is scratched, or has a burr on it.	Replace the presser foot. Contact your retailer or the nearest authorized service center.	–
	The bobbin case is scratched, or has a burr on it.	Replace the bobbin case. Contact your retailer or the nearest authorized service center.	–
A bobbin designed specifically for this machine is not used.	Incorrect bobbins will not work properly. Only use a bobbin designed specifically for this machine.	page 25	

Symptom	Probable Cause	Remedy	Reference
The upper thread breaks.	The upper thread was not threaded correctly (for example, the spool is not installed correctly, the spool cap is too big for the spool being used, or the thread has come out of the needle bar thread guide).	Correct the upper threading.	page 31
	There are knots or tangles in the thread.	Remove any knots or tangles.	–
	The selected needle is not appropriate for the thread being used.	Select a needle that is appropriate for the type of thread being used.	page 41
	The upper thread tension is too tight.	Loosen the upper thread tension.	page 59
	The thread is tangled, for example, in the bobbin case.	Remove the tangled thread. If the thread is tangled in the bobbin case, clean the race.	page 184
	The needle is bent or blunt.	Replace the needle.	page 42
	The needle is incorrectly installed.	Correctly install the needle.	
	The area around the hole in the needle plate is scratched, or has a burr on it.	Replace the needle plate. Contact your retailer or the nearest authorized service center.	–
	The area around the hole in the presser foot is scratched, or has a burr on it.	Replace the presser foot. Contact your retailer or the nearest authorized service center.	–
	The bobbin case is scratched, or has a burr on it.	Replace the bobbin case. Contact your retailer or the nearest authorized service center.	–
	A bobbin designed specifically for this machine is not used.	Incorrect bobbins will not work properly. Only use a bobbin designed specifically for this machine.	page 25
Bobbin thread does not wind neatly on the bobbin.	The thread that was pulled out was not wound onto the bobbin correctly.	Wind the thread that was pulled off around the bobbin five or six times clockwise.	page 27
	Bobbin spins slowly.	Move the sewing speed controller to the right (so that the speed will be fast).	page 28



Symptom	Probable Cause	Remedy	Reference
The lower thread is tangled or breaks.	The bobbin thread is incorrectly installed.	Correctly install the bobbin thread.	page 29
	The bobbin is scratched or does not rotate smoothly, or has a burr on it.	Replace the bobbin.	–
	The thread is tangled.	Remove the tangled thread and clean the race.	page 184
	A bobbin designed specifically for this machine is not used.	Incorrect bobbins will not work properly. Only use a bobbin designed specifically for this machine.	page 25
The thread tension is incorrect.	The upper thread was not threaded correctly.	Correct the upper threading.	page 31
	The bobbin thread is incorrectly installed.	Correctly install the bobbin thread.	page 29
	The combination of fabric, thread and needle is not correct.	Select a thread and needle that are appropriate for the type of fabric being sewn.	page 41
	The presser foot holder is incorrectly installed.	Correctly install the presser foot holder.	page 46
	The thread tension is incorrect.	Adjust the tension of the upper thread.	page 59
	A bobbin designed specifically for this machine is not used.	Incorrect bobbins will not work properly. Only use a bobbin designed specifically for this machine.	page 25
The fabric is wrinkled.	The upper thread was not threaded correctly, or the bobbin is incorrectly installed.	Correctly thread the upper thread and correctly install the bobbin thread.	page 29, page 31
	The spool is incorrectly installed.	Correctly install the spool.	page 31
	The combination of fabric, thread and needle is not correct.	Select a thread and needle that are appropriate for the type of fabric being sewn.	page 41
	The needle is bent or blunt.	Replace the needle.	page 42
	If thin fabrics are being sewn, the stitch is too long.	Shorten the stitch length or sew with stabilizer material under the fabric.	page 59, page 66
	The thread tension is incorrect.	Adjust the tension of the upper thread.	page 59

Symptom	Probable Cause	Remedy	Reference
Stitches are skipped.	The upper thread was not threaded correctly.	Correct the upper threading.	page 31
	The combination of fabric, thread and needle is not correct.	Select a thread and needle that are appropriate for the type of fabric being sewn.	page 41
	The needle is bent or blunt.	Replace the needle.	page 42
	The needle is incorrectly installed.	Correctly install the needle.	page 42
	Dust has accumulated under the needle plate or in the bobbin case.	Remove the needle plate cover and clean the race.	page 184
A high-pitched noise is made while sewing.	Dust has accumulated in the feed dogs or in the bobbin case.	Clean the race.	page 184
	The upper thread was not threaded correctly.	Correct the upper threading.	page 31
	The bobbin case is scratched, or has a burr on it.	Replace the bobbin case. Contact your retailer or the nearest authorized service center.	–
	A bobbin designed specifically for this machine is not used.	Incorrect bobbins will not work properly. Only use a bobbin designed specifically for this machine.	page 25
The thread does not pass through the eye of the needle.	The needle has not been raised to the correct position.	Press the “Needle Position” button.	page 34
	The needle is incorrectly installed.	Correctly install the needle.	page 42
The stitch is not sewn correctly.	The presser foot that is used is not appropriate for the type of stitch that you wish to sew.	Attach the presser foot that is appropriate for the type of stitch that you wish to sew.	page 70
	The thread tension is incorrect.	Adjust the tension of the upper thread.	page 59
	The thread is tangled, for example, in the bobbin case.	Remove the tangle thread. If the thread is tangled in the bobbin case, clean the race.	page 184
The fabric does not feed.	The feed dogs are lowered.	Slide the drop feed lever to the right (as seen from the rear of machine).	page 110
	The stitch is too short.	Lengthen the stitch length.	page 59
	The presser foot that is used is not appropriate for the type of stitch that you wish to sew.	Attach the presser foot that is appropriate for the type of stitch that you wish to sew.	page 70
	The thread is tangled, for example, in the bobbin case.	Remove the tangled thread. If the thread is tangled in the bobbin case, clean the race.	page 184

Symptom	Probable Cause	Remedy	Reference
The sewing lamp does not come on.	The sewing lamp is damaged.	Contact your retailer or the nearest authorized service center.	–
	The machine is not turned on.	Turn on the machine.	page 19
Nothing appears in the LCD.	The brightness of the LCD is either too light or too dark.	Adjust the brightness of the LCD.	page 194
Machine does not operate when button is pressed.	An animation is displayed on the LCD.	Touch the LCD with your finger, and the animation will disappear.	page 20
Embroidery unit does not move.	No pattern selected.	Select a pattern.	page 159
	The embroidery unit is not set up correctly.	Set the embroidery unit up correctly.	page 150
Embroidery not neatly done.	The fabric is not fully stretched on the embroidery frame. The fabric is loose.	Stretch the fabric properly on the embroidery frame.	page 154
	No stabilizer material is attached.	Always use stabilizer material for embroidery with stretch fabrics, thin fabrics, fabrics with a loose weave and fabrics where stitches easily contract.	page 153
	The thread is tangled and the bobbin case, etc., is plugged up.	Remove the tangled thread. When the bobbin case is plugged up, clean the race.	page 184
	The thread tension is incorrect.	Adjust the tension of the upper thread.	page 173
	Objects are placed near the carriage or embroidery frame.	If the embroidery unit carriage or embroidery frame bumps into objects, the pattern will be misaligned. Do not place objects within the range of embroidery frame motion.	page 151
	Material coming out of the embroidery frame is causing problems.	Stretch the fabric on the frame once again so that the material coming out of the embroidery frame does not cause problems, rotate the pattern and embroider.	–
	A heavy fabric is being embroidered, and the fabric is hanging off the table.	If embroidery is done with the fabric hanging off the table, the embroidery unit movement will be impaired. Support the fabric while embroidering.	–
	The fabric is catching. It is pinched.	Stop the sewing machine and set the fabric up correctly.	–
	The carriage was moved while the embroidery frame was being removed or attached during embroidery.	If the carriage is moved during the process, the pattern may be misaligned. Be careful when removing or attaching the embroidery frame.	–

Error messages

When erroneous operations are performed messages and advice on operation will be displayed on the LCD. Follow what is displayed. The message may disappear if the operation is performed correctly. The message will disappear if **CLOSE** is pressed while the message is displayed.

Error Message	Probable Cause
<p>❗ Can not recognize the data. The data may be corrupted.</p>	There is a possibility that the data for the selected pattern is corrupted.
<p>❗ Cannot sew on this screen.</p>	Either the “Start/Stop” button or the “Reverse/Reinforcement Stitch” button was pressed at a screen other than the sewing screen.
<p>❗ Change the speed controller mode to “OFF”.</p>	The “Start/Stop” button was pressed without connecting the foot controller while the setting for adjusting the stitch width using the sewing speed controller is set to “ON”. You have selected a pattern for which width control cannot be used.
<p>❗ Change to the single needle mode, and replace the needle.</p> <p>CANCEL </p>	The twin needle setting is selected while a pattern that cannot be sewn with the twin needle is selected. Press  to cancel the twin needle setting. If the twin needle is installed, replace it with a single needle. Then, select the pattern again. Press CANCEL to return to the previous screen.
<p>❗ Check and rethread the upper thread.</p>	Upper thread broken. Upper thread not set up correctly. Upper thread has run out. CAUTION Be sure to rethread the machine. If you press the “Start/Stop” button without rethreading the machine, the thread tension may be wrong or the needle may break and cause injury.
<p>❗ Data volume is too large for this pattern.</p>	You tried to create a design with too many points with the My Custom Stitch function.
<p>Deleting...</p>	The machine is deleting a previously saved pattern while in embroidery edit mode.
<p>❗ Disconnect the foot controller.</p>	The “Start/Stop” button was pressed while the foot controller was connected. You tried to use the foot controller for embroidery.
<p>❗ Do not change the USB media while it is being read.</p>	You attempted to select a pattern after the USB media containing the pattern has been disconnected, then reconnected.
<p>❗ Finish editing the pattern before sewing the pattern.</p>	The “Start/Stop” button was pressed before the editing was completed with the My custom stitch function.

Error Message	Probable Cause
❗ Insert an embroidery card.	 on the LCD was pressed when no card was inserted.
❗ Lift the buttonhole lever.	A stitch other than the buttonhole, bar tack or darning stitch was selected and the “Start/Stop” button was pressed while the buttonhole lever is lowered.
❗ Load USB media.	You recalled a pattern while no USB media is connected.
❗ Lower the buttonhole lever.	The buttonhole, bar tack or darning stitch was selected and the “Start/Stop” button was pressed while the buttonhole lever is raised.
❗ Lower the presser foot lever.	The “Start/Stop” button, “Reverse/Reinforcement Stitch” button or “Thread Cutter” button was pressed while the presser foot was raised.
❗ No more stitches can be combined.	You tried to combine more than 70 decorative stitches, satin stitches, cross stitches or combined utility stitches.
❗ Not enough available memory. Delete another pattern?	The memory is full and the stitch or pattern cannot be saved.
❗ OK to delete the selected pattern?	You pressed the back key or the utility stitch key or the embroidery key while a pattern was selected.
❗ OK to save the current settings?	You changed the stitch pattern settings, and then tried to save them by pressing the manual memory key.
❗ Press the needle position button to raise the needle.	You tried to select an embroidery pattern or change the layout when the needle was down. The machine is turned on while the needle is lowered and the embroidery unit is attached.
❗ Raise presser foot lever.	This message is displayed when the embroidery unit is trying to initialize while the embroidery foot is lowered.
❗ Reduce the number of patterns.	A pattern was being retrieved from a USB flash drive (USB flash memory) containing more than 200 embroidery patterns. In addition, this message will appear if embroidery patterns containing many colors have been saved on the USB media, even if it contains data for no more than 200 patterns.
Retrieving the pattern. Wait a moment.	Retrieving the pattern
❗ Return the bobbin winding shaft to left.	The “Reverse/Reinforcement Stitch” button, “Needle Position” button or “Thread Cutter” button was pressed while the bobbin winder shaft is moved to the right.

Error Message	Probable Cause
Saving...	A pattern is being saved.
❗ Select a pattern.	The “Start/Stop” button or “Reverse/Reinforcement Stitch” button was pressed when no pattern is selected.
❗ The bobbin thread is running out.	Bobbin thread has run out. Little bobbin thread remains.
⚠ The carriage of the embroidery unit will move.	When the embroidery unit is attached.
❗ The pattern is too large for the embroidery frame.	You tried to set a number of characters that will not fit within the frame.
⚠ The safety device has been activated.	The upper thread has become tangled around the bobbin case, and the needle is bent and hitting the needle plate, etc., so the sewing machine stops (refer to page 186).
❗ This button does not operate when the embroidery unit is attached.	You tried a function that cannot be used when the embroidery unit is attached.
❗ This embroidery card can not be used on this machine.	A card that cannot be used with this product has been inserted, and you tried to select a pattern from the card.
❗ This embroidery pattern can not be used on this machine.	An embroidery pattern incompatible with this machine was selected.
❗ This key does not operate when the embroidery unit is attached.	The utility stitch or character stitch key was pressed while the embroidery unit is attached.
❗ This pattern cannot be used.	You try to retrieve a pattern downloaded as one for a different machine.
❗ Total size of the pattern is too large. Rotate the pattern.	The machine is in embroidery mode and the combined character pattern is too large for the embroidery frame. You can rotate the pattern 90 degrees and continue combining characters.
❗ Turn off the machine, and attach the embroidery unit.	The “Start/Stop” button, the embroidery key, or the memory key is pressed in embroidery mode, but the embroidery unit is not attached.
Winding bobbin thread...	The bobbin winder is winding the bobbin.

Adjusting the LCD

If nothing appears in the LCD when the sewing machine is turned on, the brightness of the LCD is either too light or too dark. In such a case, perform the following operation.

- 1 Turn off the sewing machine.

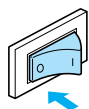

- 2 Turn on the sewing machine while pressing anywhere on the screen.

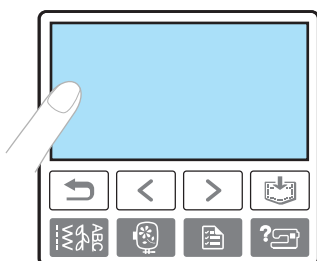

- 3 Press **-** or **+**.



- 4 Turn off the sewing machine, then turn it on again.

Operation beep

Each time a key is pressed you will hear one beep. If an incorrect operation is performed you will hear two or four beeps.

- **If a key is pressed (correct operation)**
One beep sounds.
- **If an incorrect operation is performed**
Two or four beeps sound.
- **If the machine locks up, for example, because the thread is tangled**
The sewing machine beeps for four seconds and the machine automatically stops.
Be sure to check for the cause of the error, and correct it before continuing to sew.

Canceling the operation beep

When the sewing machine is purchased, it is set to beep each time an operation panel key is pressed. This setting can be changed so that the machine does not beep.

- 1 Turn on the sewing machine.

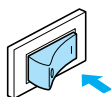

▶ The LCD comes on.

- 2 Press  (Settings key) on the operation panel.

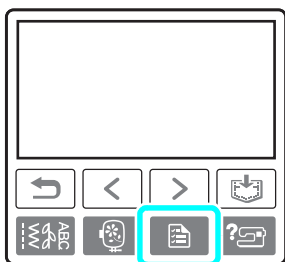

▶ The settings screen appears.

- 3 Press  (Next page key) three times.

- 4 Press OFF for the buzzer.



▶ The screen for changing the beep setting appears.

- 5 Press  (Back key).



▶ The initial screen appears again.

Upgrading Your Machine's Software Using USB Media

You can use USB media and a computer to download software upgrades for your sewing machine. When an upgrade program is available on our website at "<http://solutions.brother.com>", please download the file(s) following the instructions on the website and steps listed below.



Note

- When using USB media to upgrade the software, check that no data other than the upgrade file is saved on the USB media being used before starting to upgrade.
- Upgrade file can be recalled from a USB flash drive (USB flash memory) of any size.



Memo

- When the machine's software is upgraded, saved combinations of character and decorative stitches are erased. However, saved embroidery patterns are not erased.

- 1 Press and hold the  (Settings key) while turning on the machine.

▶ The following screen appears.

```
Connect the USB
media containing
the upgrade file.
```

LOAD

- 2 Insert the USB media into the USB port on the machine. The media device should only contain the upgrade file.

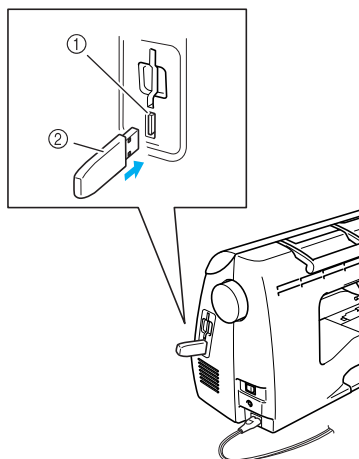

- ① USB port for media
- ② USB media



Note

- When using USB media equipped with an access indicator, the access indicator will begin flashing after the media is inserted into your computer or machine, and may take about 5 to 6 seconds before the media is recognized. (The length of time differs depending on the USB media.)

- 3 Press .

▶ The following screen appears.

```
Saving the
upgrade file.
Do not turn
main power to OFF.
```



Note

- If an error occurred, a text error message will appear. At this time, turn the machine off, and then start the procedure again from step 1.

- 4 When the following screen appears, upgrading is completed.

```
Upgrade complete.
```

- 5 Remove the USB media, and turn the machine off and on again.

Index

Numerics

- 1/4 inch quilting foot 12, 108
- 1/4 inch quilting foot with guide 12

A

- accessories 10, 12
- adjustable zipper/piping foot 11, 101
- adjusting layout 171
- adjusting stitch length 59
- adjusting stitch width 58
- adjusting thread tension 59
- air vent 14
- alternate bobbin case 166, 174
- appliqué 105
- appliqué pattern selection 169
- appliqué stitch 105
- attaching presser foot holder 46
- attaching stabilizer material 153
- attributes 21
- automatic reverse/reinforcement stitches 61
- automatic thread cutting 62

B

- back key 16
- bar tack stitch 113
- basic sewing 50
- basic stitching 85
- basting stitch 85
- beep 194
- blind hem stitch 87
- bobbin 11
- bobbin case 11, 166
- bobbin case removal 184
- bobbin cover 14
- bobbin installation 29
- bobbin thread, pulling up 39
- bobbin threading 29
- bobbin winder 13
- bobbin winding 25
- bobbin winding thread guide and pretension disk 13, 27
- button guide plate 91
- button sewing 94
- buttonhole lever 14
- buttonhole sewing 90
- buttonhole stitching 89
- buzzer 194

C

- care 184
- changing sewing direction 64
- character stitches 77, 128
- character storage 180
- characters, retrieving 180

- checking needle 42
- cleaning bobbin case 184
- cleaning brush 11
- cleaning machine surface 184
- combining patterns 132
- concealed seams 96
- country thread 21
- crazy quilt stitching 107
- cross stitches 77, 128
- cuffs 47
- curve sewing 64
- custom stitches 139
- cutting thread 56
- cutting thread automatically 62
- cylindrical pieces 47

D

- darning 115
- darning stitch 113
- decorative satin stitches 77, 128
- decorative stitches & patterns 77, 128
- deleting saved pattern 136
- design examples 142
- designing stitch patterns 139

E

- elastic tape 103
- embroidering 144, 167
- embroidering pattern 167
- embroidering steps 146
- embroidery bobbin thread 11, 12
- embroidery card slot 14
- embroidery cards 165
- embroidery character selection 163
- embroidery data 178
- embroidery fabric preparation 153
- embroidery foot installation 147
- embroidery foot removal 149
- embroidery frame 154
- embroidery frame installation 157
- embroidery frame removal 158
- embroidery key 16
- embroidery pattern selection 159
- embroidery pattern types 159
- embroidery sets 11, 12
- embroidery sheets 155
- embroidery threads 144
- embroidery unit connector slot 13
- embroidery unit installation 150
- embroidery unit removal 152
- error messages 191
- even seam allowance 66
- examples of designs 142
- extra spool pin 11, 36
- eyelet punch 11
- eyelet stitching 117

F	
fabric positioning	52
fagoting	121
fagoting stitch	120
feed dog position switch	14
feed dogs	14
flat bed attachment	13
foot controller	11, 53
foot controller jack	14
frame pattern selection	164
fraying, preventing	81
free-arm sewing	47
free-motion quilting	110
front view	13
G	
general sewing procedures	50
grid sheet set	11
H	
handle	14
handwheel	14
hard case	11
heirloom stitching	125
help key	16, 23
horizontal stitching	118
I	
inserting a piping	102
installing bobbin	29
J	
joining	124
joining stitch	105, 120
K	
knee lifter	11, 67
knee lifter mounting slot	13, 67
L	
layout adjustment	171
LCD	16, 160
LCD button	161
LCD messages	191
LCD operation	20, 160
leather/vinyl fabrics	66
M	
machine surface cleaning	184
main power switch	14, 19
maintenance	184
manual needle threading	35
memory key	16
mirroring stitches	63
My Custom Stitch	139
N	
needle bar thread guide	14
needle condition	42
needle plate	14
needle plate cover	14
needle plate marking	67
needle position button	15
needle position, changing	86
needle replacement	42
needle set	11
needle threader	34
needle threader lever	13
needle threading	34
needle types, sizes & uses	41
needles	40
next page key	16
non stick foot	11, 66
O	
open toe foot	11
operation beep	194
operation buttons	13, 15, 53
operation keys	16, 160
operation panel	13, 16
operation problems	186
operations	23
optional accessories	12
overcasting stitches	81, 82
P	
pant legs	47
parallel stitches	36
part names & functions	13
patchwork	105, 107
pattern combinations	132
pattern embroidery	167
pattern realignment	136
pattern repetition	133
pattern retrieving	135
pattern sewing	128
pattern size	129
pattern storage	135
pattern, deleting	136
piecing	107
piecing straight stitch	105
piping inserting	102
plug	19
positioning fabric	52
power cord, jack, switch & supply	19
power supply jack	14
power switch	14
preparations for embroidering	144
presser foot	14
presser foot holder	14
presser foot holder installation	46
presser foot holder removal	46
presser foot lever	13, 14
presser foot pressure dial	14
presser foot replacement	44
previous page key	16
pulling up bobbin thread	39

Q

quick reference guide	11
quilt stitching	105
quilting	109
quilting foot	12
quilting guide	12, 110
quilting stippling	105
quilting stitch	105

R

race	184
realigning pattern	136
reinforcement stitching	55, 113
release button	152
removing presser foot holder	46
repeating patterns	133
replacing needle	42
replacing presser foot	44
resewing	175
retrieving pattern	135
reverse stitching	55
reverse/reinforcement stitch button	15, 55
reverse/reinforcement stitches, automatic	61

S

safety instructions	1
satin stitch length, changing	130
satin stitches	77, 128
satin stitching	111
saving patterns	135, 180
scallop stitch	120
scallop stitching	122
scissors	11
screwdriver	11
seam allowance, even	66
seam ripper	11, 92
securing stitching	55
selecting embroidery patterns	159
selecting stitches	51, 70, 77
settings key	16
sewing basics	50
sewing direction change	64
sewing machine help key	16
sewing speed controller	13, 15, 53, 112
shell tuck stitch	120, 123
side cutter	83
size	129
smocking	122
smocking stitch	120
solving operation problems	186
spool cap	11
spool net	11, 27
spool of thread	31
spool pin	11
stabilizer material	153
start/stop button	15, 53
step pattern	131
stippling	105
stitch density	129
stitch guide foot	11, 66

stitch length adjustment	59
stitch selection	51, 70, 77
stitch settings	70
stitch type selection screen	20
stitch types	77
stitch width adjustment	58
stopping embroidering	176
straight stitch	70, 85, 96, 107
stretch fabrics	66, 103
stretch stitch	103

T

thick fabrics	65
thin fabrics	66
thread cutter	13, 57
thread cutter button	15, 56
thread cutting	56
thread cutting, automatic	62
thread guide cover	13
thread guide disk	14
thread guide plate	13
thread spools	31
thread tension adjustment	59, 173
Threading	32
threading bobbin	29
threading needle	34
threading needle manually	35
tips	64
top cover	13
touch panel	16
trial sewing	64
triple stretch stitch	85, 113
troubleshooting	186
turning machine on/off	19
twin needle	11, 36
twin needle sewing	36

U

upgrading	196
upper thread	31
upper thread spool	31
upper thread tension	59
USB flash drive (USB flash memory)	181
USB port connector	14
utility stitch key	16
utility stitch selection screen	20
utility stitches	70, 77

W

walking foot	12
winding bobbin	25
wing needle	125

Z

zigzag stitches	82, 103, 105
zigzag width adjustment	58
zipper sewing	96
zipper stitching	101

