

DISNEY DESIGN GUIDE
DISNEY-DESIGNANLEITUNG
GUIDE DE MODELES DISNEY
DISNEY ONTWERPENGUIDS
GUIDA AI DISEGNI DISNEY
GUÍA DE DISEÑO DISNEY

Disney

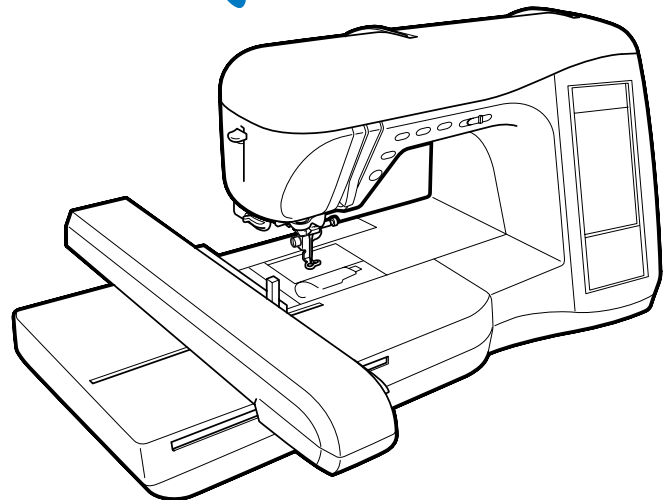

brother®
at your side

WARNING
AVERTISSEMENT
AVVERTIMENTO

WARNUNG
WAARSCHUWING
ADVERTENCIA

The embroidery patterns which are pre-programmed into this sewing machine are for personal, private use only. Any commercial or business use is strictly forbidden by copyright laws.

Die in dieser Maschine vorprogrammierten Stickmuster sind nur für Ihre persönliche Verwendung vorgesehen. Jede geschäfts- oder handelsmäßige Verwendung ist urheberrechtlich untersagt.

Les motifs de broderie pré-programmés dans cette machine à coudre sont destinés à l'utilisation personnelle seulement. Toute utilisation commerciale est rigoureusement interdite par les lois des droits d'auteur.

De borduurpatronen die in deze naaimachine zijn voorgeprogrammeerd zijn uitsluitend voor persoonlijk, privé gebruik bestemd. Elk gebruik voor handels-of zakelijke doeleinden is vanwege auteursrechten strikt verboden.

I disegni di ricamo che si trovano pre-programmati in questa macchina per cucire sono solo per uso privato, personal. Qualsiasi altro uso, commerciale o per affari, è rigorosamente proibito, secondo le leggi di tutela dei diritti di copyright.

Los bordados preprogramados en la máquina de coser son sólo para uso personal y privado. El uso comercial está estrictamente prohibido por las leyes de protección de los derechos de copia.

Refer to the operation manual for detailed instruction.

Also, there are differences in the keys and screens depending on the display language. In this guide, English screens are used for basic explanations.

Einzelheiten entnehmen Sie bitte der Bedienungsanleitung.

Je nachdem, welche Sprache für die Bildschirmanzeigen gewählt wurde, ergeben sich im Hinblick auf Tasten Schirmbilder eventuell Unterschiede.

Die grundlegende Bedienung der Maschine ist in dieser Anleitung am Beispiel von Schirmbildern mit englischem Text erklärt.

Pour les instructions détaillées, voir le manuel d'instruction.

Par ailleurs, il y a des différences dans les touches et les écrans en fonction de la langue d'affichage.

Dans ce guide, les explications de base utilisent les écrans anglais.

Zie de handleiding voor gedetailleerde instructies.

Er zijn verschillen in de toetsen en schermen afhankelijk van de ingestelde taal.

In de beschrijvingen in deze beknopte handleiding worden de Engelse schermen gebruikt.

Fara riferimento al manuale d'istruzione per istruzioni dettagliate.

Inoltre, ci sono differenze nei tasti e nelle schermate a seconda della lingua visualizzata.

In questa guida, le schermate in inglese sono usate per le spiegazioni basilari.

Consulte el manual de instrucciones para ver más detalles.

Además, dependiendo del idioma visualizado algunos botones y pantallas podrán ser diferentes.

En esta guía, para las explicaciones básicas se emplean pantallas en inglés.

Before Use
Avant l'utilisation
Prima dell'uso

Vor der Inbetriebnahme
Alvorens te gebruiken
Antes de usar

When this unit's power is turned on, the screen will display the opening animation. Touch the display to move on to further machine functions.

Wenn dieses Gerät eingeschaltet wird, erscheint eine Eingangsanimation. Berühren Sie die Anzeige, um andere Funktionen zu bedienen.

Lorsque vous mettez la machine sous tension, l'écran affiche l'animation d'ouverture. Pour passer à l'affichage des fonctions de la machine, effleurer l'affichage.

Wanneer dit apparaat wordt ingeschakeld, wordt de beginanimatie getoond. Druk op de display om door te gaan naar de overige machinefuncties.

Quando questa unità viene accesa, rimane visualizzata l'animazione di apertura. Sfiocare il display per andare avanti sulle altre funzioni della macchina.

Cuando encienda la máquina, la pantalla mostrará la animación de inicio. Toque la pantalla para cambiar a otras funciones de la máquina.

Selecting Disney characters
Sélection des caractères Disney.
Selezione dei caratteri Disney

Einstellen von Disney-Charakter
Kiezen van Disney karakters
Seleccionando a Disney.

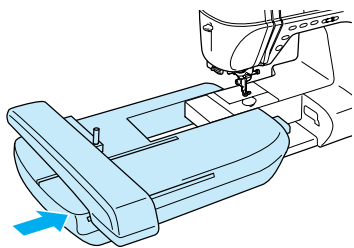

- 1** Turn off the power and make preparations for embroidery.
Schalten Sie die Maschine aus und nehmen Sie die Vorbereitungen zum Sticken vor.
Mette la machine hors tension et effectuer les préparatifs pour la broderie.
Schakel de machine uit en maak de voorbereidingen voor het borduurwerk.
Spegnera l'unità ed eseguire i preparativi per il ricamo.
Apague la alimentación y prepárese para bordar.
- Please see the machine's operation manual.
 - Dazu wird auf die Bedienungsanleitung der Nähmaschine verwiesen.
 - Se reporter au manuel d'instructions de la machine.
 - Zie de handleiding van de machine.
 - Leggere il manuale d'istruzione della macchina.
 - Consulte el manual de instrucciones de la máquina.



- 2** Turn on the power switch and touch the screen. The screen at left will be displayed.
Schalten Sie den Netzschalter ein und berühren Sie die Bildschirmanzeige. Der linksstehende Bildschirm wird angezeigt.
Mette l'interrupteur d'alimentation sous tension et effleurer l'écran. L'écran de gauche s'affiche.
Schakel de aan/uit schakelaar in en druk op het scherm. Het scherm links zal worden getoond.
Accendere l'interruttore di alimentazione e sfiorare lo schermo. Appare lo schermo a sinistra.
Conecte el interruptor principal y toque la pantalla. Se exhibirá la pantalla a la izquierda.

- 3** Press **OK**. The carriage of the embroidery unit will move to the initial setting position.
Drücken Sie auf **OK**. Der Wagen der Stickereivorrichtung wird in die Ausgangsposition bewegt.
Effleurer **OK**. Le chariot de l'unité de broderie se place á la position du réglage initial.
Druk op **OK**. De wagen van de borduureenheid zal naar de beginpositie verplaatst worden.
Sfiorare **OK**. Il carrello dell'unità di ricamo si sposta nella posizione di impostazione iniziale.
Toque **OK**. El carro de la unidad de bordad se moverá a la posición de ajuste inicial.

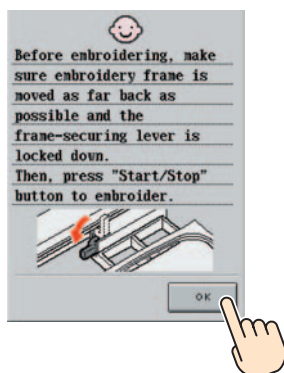

- 4** The confirmation message to lower the frame-securing lever will appear and press **OK**.
Die Bestätigungsmeldung zum Absenken des Rahmen-Haltehebels erscheint und **OK**.
Le message de confirmation pour l'abaissement du levier de sécurité de cadre apparaît et **OK**.
Er verschijnt een bevestigingsbericht om de kader-borghendel omlaag te zetten, met daarbij de aanduiding **OK** voor sluiten.
Apparirà il messaggio di conferma all'abbassamento della leva di bloccaggio del telaio e **OK**.
Aparecerá el mensaje de confirmación para bajar la palanca de sujeción del bastidor y **OK**.

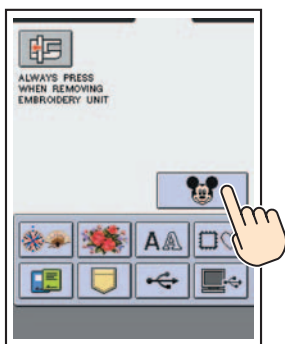

- 5** Press  .
 Drücken Sie auf  .
 Effleurer  .
 Druk op  .
 Sfiurare  .
 Toque  .

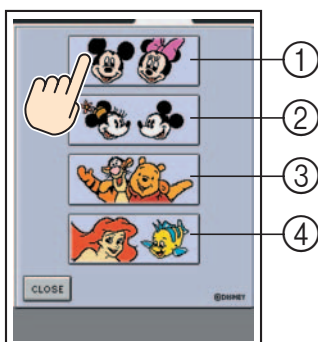



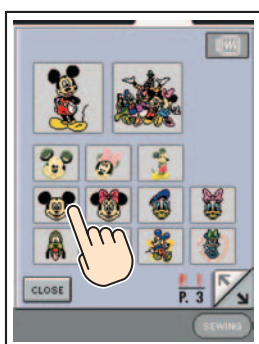

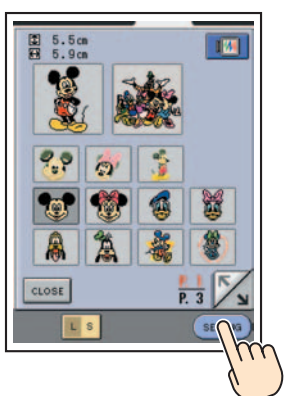

- 6** Select the type of pattern.
 Wählen Sie die Stickmusterart.
 Sélectionner le type du motif.
 Selecteer het type patroon.
 Selezionare il tipo di disegno.
 Seleccione el tipo de patrón.
- ① Standard / Standard / Standard / Standaard / Moderno / Normal
 - ② Vintage / Traditionell / Classique / Klassiek / D'época / Clásico
 - ③ Pooh and friends / Pooh und Freunde / Pooh et ses amis / Poeh en zijn vrienden / Pooh e amici / Pooh y sus amigos
 - ④ Film property / Filmrechte / Propriété du film / Film-eigendom / Proprietà film / Propiedad de la película







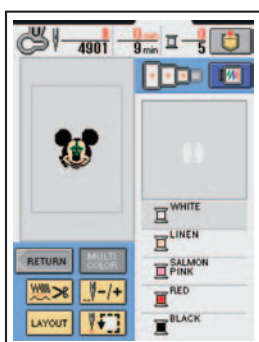

- 7** Select the desired pattern.
 Wählen Sie das gewünschte Stickmuster.
 Sélectionner le motif désiré.
 Selecteer het gewenste patroon.
 Selezionare il disegno desiderato.
 Seleccione el patrón deseado.



- 8** If you would like to change the size of the pattern, press  until the highlighted display matches the size you would like to select.
 Drücken Sie zum Einstellen der Mustergröße auf  , um die hervorgehobene Anzeige auf die gewünschte Größe einzustellen.
 Pour changer la taille du motif, effleurer  jusqu'à ce que l'affichage mis en valeur corresponde à la taille devant être sélectionnée.
 Als u het formaat van het patroon wilt wijzigen, op  drukken totdat de verlichte display overeenkomt met het formaat dat u wilt selecteren.
 Se si desidera cambiare la grandezza del disegno, sfiorare  fino a che il display evidenziato corrisponde alla grandezza che si desidera selezionare.
 Si desea cambiar el tamaño del patrón, toque  hasta que la exhibición destacada esté de acuerdo con el tamaño que desea seleccionar.



- 9** After making the selection, press  . The sewing screen will be displayed.
 Drücken Sie nach der Auswahl auf  . Der Stickereibildschirm wird angezeigt.
 Après avoir effectué la sélection, effleurer  . L'écran de broderie s'affiche.
 Druk na het maken van de selectie op  . Het borduurscherm zal worden getoond.
 Dopo aver eseguito la selezione, sfiorare  . La schermata di ricamo viene visualizzata.
 Después de realizar la selección, toque  . Se exhibirá la pantalla de bordado.

Color Change Table

Tableau des changements de couleur

Tabella di cambiamento colori

Farbänderungstabelle

Kleurveranderingstabel

Tabla de cambio de color

- The figures in shaded areas indicate the estimated time needed for the pattern to be embroidered. They do not include the time required to change threads.
- Die Angaben in den schattierten Feldern beziehen sich auf die voraussichtliche Zeit, die zum Sticken des Musters benötigt wird. In dieser Zeit ist das Wechseln der Fäden nicht enthalten.
- Les chiffres contenus dans les zones grisées indiquent le temps estimé nécessaire pour le motif à broder. Ils ne prennent pas en compte le temps nécessaire pour changer les fils.
- De getallen in de gearceerde gedeelten geven bij benadering de tijd aan die nodig is voor het borduren van het patroon. Hierbij is niet inbegrepen de tijd die nodig is voor het verwisselen van het garen.
- I numeri nelle parti tratteggiate indicano il tempo stimato necessario al ricamo del disegno. Essi non includono il tempo necessario al cambio i fili.
- Los números sombreados indican el tiempo estimado necesario para bordar el patrón. No incluyen el tiempo necesario para cambiar los hilos.

Refer to the operation manual for details on how to embroider the pattern.

Für das Sticken des Musters wird auf die Bedienungsanleitung verwiesen.

Se reporter au mode d'emploi pour les détails concernant la façon de broder le motif.

Zie de bedieningshandleiding voor nadere bijzonderheden betreffende het borduren van het patroon.

Per i dettagli su come ricamare il disegno, far riferimento al manuale d'istruzioni.

Consulte el manual de instrucciones por detalles sobre como bordar el patrón.

Note: The Disney character patterns built into this unit cannot be resized or flipped.

Hinweis: Die in dieser Einheit eingebauten Disney-Figuren können nicht in der Größe verändert oder umgedreht werden.

Remarque : Les motifs des personnages de Disney intégrés dans l'unité ne peuvent être ni redimensionnés ni orientés différemment.

Opmerking: De Disney-figuren die in deze borduureenheid zijn ingebouwd, kunnen niet van grootte worden veranderd of worden omgedraaid.

Nota: I motivi con personaggi Disney inclusi in questa unità non possono essere ridimensionati o invertiti.

Nota: Los diseños de personajes de Disney incorporados en esta unidad no podrán ser cambiados de tamaño ni darles la vuelta.

A pattern ★ is an embroidery pattern which uses appliqué: No. 40, 41, 79.

Ein Muster ★ ist ein Stickmuster, das Applikation verwendet: Nr. 40, 41, 79.

Un motif ★ est un motif de broderie qui utilise l'appliqué: N° 40, 41, 79.

Een patroon met ★ is een borduurpatroon dat gebruik maakt van applique: Nr. 40, 41, 79.

I modelli ★ sono modelli di cucitura che impiegano il riporto: N. 40, 41, 79.

Un patrón ★ es un patrón bordado que utiliza dibujo aplicado N° 40, 41, 79

No.2

77min

1	(405)
2	(214)
3	(079)
4	(017)
5	(001)
6	(205)
7	(800)
8	(515)
9	(507)
10	(079)
11	(208)
12	(612)
13	(900)
14	(001)
15	(209)
16	(019)
17	(001)
18	(800)
19	(079)
20	(307)
21	(513)
22	(900)
23	(001)
24	(612)
25	(214)
26	(017)
27	(079)
28	(208)
29	(086)
30	(085)
31	(058)
32	(019)
33	(900)
34	(019)
35	(208)
36	(800)
37	(085)
38	(086)
39	(001)
40	(900)
41	(307)
42	(085)
43	(001)
44	(800)
45	(079)
46	(900)
47	(001)

↓17.9cm ↔15.6cm



No.1

81min

1	(800)
2	(001)
3	(900)
4	(208)
5	(900)
6	(001)
7	(900)
8	(307)
9	(900)
10	(079)
11	(800)
12	(001)
13	(900)

↓25.6cm ↔15.4cm

EMBROIDERY





- No.3** 17min
- 1 (000)
 - 2 (747)
 - 3 (020)
 - 4 (100)
 - 5 (158)
 - 6 (122)
 - 7 (133)
 - 8 (000)
 - 9 (242)
 - 10 (025)
 - 11 (000)
 - 12 (745)
 - 13 (747)
 - 14 (100)
 - 15 (242)
- ↓7.6cm ↔7.7cm

COUNTRY



- No.6** 9min/6min
- 1 (001)
 - 2 (307)
 - 3 (079)
 - 4 (800)
 - 5 (900)
- L: ↓5.5cm ↔5.9cm
S: ↓3.9cm ↔4.2cm



- No.7** 11min/7min
- 1 (001)
 - 2 (307)
 - 3 (079)
 - 4 (800)
 - 5 (086)
 - 6 (900)
- L: ↓6.3cm ↔5.7cm
S: ↓4.5cm ↔4.1cm



- No.12** 32min
- 1 (205)
 - 2 (209)
 - 3 (405)
 - 4 (030)
 - 5 (001)
 - 6 (307)
 - 7 (405)
 - 8 (800)
 - 9 (214)
 - 10 (900)
- ↓11.5cm ↔10.6cm



- No.4** 20min
- 1 (747)
 - 2 (745)
 - 3 (020)
 - 4 (122)
 - 5 (024)
 - 6 (133)
 - 7 (158)
 - 8 (122)
 - 9 (133)
 - 10 (000)
 - 11 (242)
 - 12 (025)
 - 13 (000)
 - 14 (745)
 - 15 (747)
 - 16 (100)
- ↓9.1cm ↔7.8cm

COUNTRY

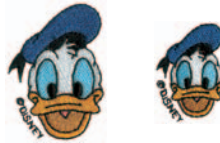

- No.8** 6min/4min
- 1 (017)
 - 2 (001)
 - 3 (079)
 - 4 (214)
 - 5 (208)
 - 6 (405)
 - 7 (900)
- L: ↓5.1cm ↔3.6cm
S: ↓3.8cm ↔2.5cm

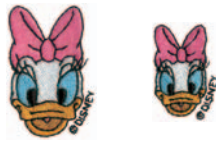

- No.9** 6min/4min
- 1 (017)
 - 2 (001)
 - 3 (079)
 - 4 (214)
 - 5 (208)
 - 6 (085)
 - 7 (900)
- L: ↓5.0cm ↔3.2cm
S: ↓3.6cm ↔2.4cm



- No.13** 27min
- 1 (001)
 - 2 (307)
 - 3 (800)
 - 4 (405)
 - 5 (017)
 - 6 (513)
 - 7 (900)
- ↓12.1cm ↔11.0cm

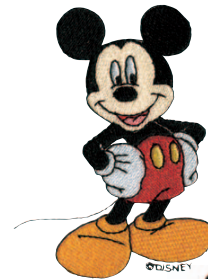

- No.14** 17min/11min
- 1 (208)
 - 2 (205)
 - 3 (800)
 - 4 (001)
 - 5 (079)
 - 6 (307)
 - 7 (900)
 - 8 (001)
- L: ↓10.4cm ↔7.7cm
S: ↓7.7cm ↔5.7cm



- No.5** 44min
- 1 (747)
 - 2 (745)
 - 3 (334)
 - 4 (335)
 - 5 (354)
 - 6 (331)
 - 7 (734)
 - 8 (745)
 - 9 (747)
 - 10 (020)
 - 11 (149)
 - 12 (158)
 - 13 (126)
 - 14 (000)
 - 15 (020)
 - 16 (000)
 - 17 (745)
 - 18 (747)
 - 19 (020)
 - 20 (100)
 - 21 (000)
 - 22 (242)
 - 23 (025)
 - 24 (000)
 - 25 (747)
 - 26 (100)
 - 27 (264)
- ↓17.1cm ↔10.2cm

COUNTRY

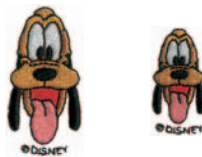

- No.10** 6min/3min
- 1 (001)
 - 2 (800)
 - 3 (079)
 - 4 (214)
 - 5 (900)
- L: ↓5.6cm ↔2.7cm
S: ↓4.0cm ↔1.9cm

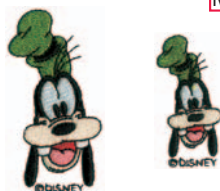

- No.11** 7min/4min
- 1 (001)
 - 2 (307)
 - 3 (800)
 - 4 (079)
 - 5 (513)
 - 6 (900)
- L: ↓6.9cm ↔3.5cm
S: ↓4.9cm ↔2.4cm

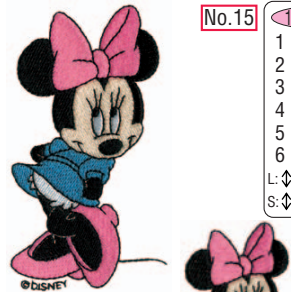

- No.15** 17min/10min
- 1 (001)
 - 2 (307)
 - 3 (019)
 - 4 (085)
 - 5 (900)
 - 6 (001)
- L: ↓10.9cm ↔5.9cm
S: ↓7.9cm ↔4.3cm





- No.16** 17min/11min
- 1 (017)
 - 2 (001)
 - 3 (079)
 - 4 (214)
 - 5 (205)
 - 6 (208)
 - 7 (405)
 - 8 (800)
 - 9 (900)
- L: \updownarrow 9.9cm \leftrightarrow 7.9cm
S: \updownarrow 7.1cm \leftrightarrow 5.7cm



- No.20** 23min
- 1 (513)
 - 2 (010)
 - 3 (124)
 - 4 (810)
 - 5 (017)
 - 6 (085)
 - 7 (001)
 - 8 (307)
 - 9 (085)
 - 10 (086)
 - 11 (208)
 - 12 (019)
 - 13 (017)
 - 14 (800)
 - 15 (079)
 - 16 (900)
 - 17 (001)
- \updownarrow 8.4cm \leftrightarrow 8.9cm

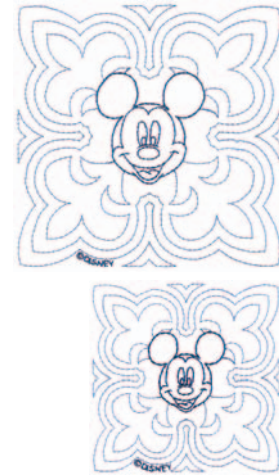

- No.26** 4min/3min
- 1 (015)
 - 2 (575)
- L: \updownarrow 12.6cm \leftrightarrow 12.6cm
S: \updownarrow 9.0cm \leftrightarrow 9.0cm
- COUNTRY (COUNTRY)

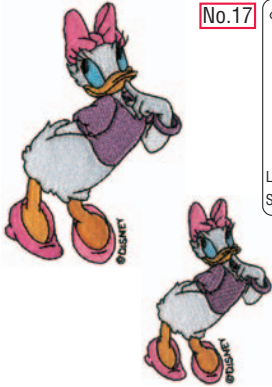

- No.17** 13min/8min
- 1 (017)
 - 2 (001)
 - 3 (612)
 - 4 (208)
 - 5 (085)
 - 6 (900)
- L: \updownarrow 9.9cm \leftrightarrow 6.7cm
S: \updownarrow 7.1cm \leftrightarrow 4.8cm

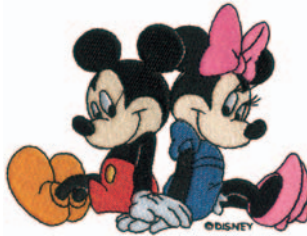

- No.21** 26min
- 1 (001)
 - 2 (307)
 - 3 (019)
 - 4 (085)
 - 5 (800)
 - 6 (205)
 - 7 (208)
 - 8 (900)
 - 9 (001)
- \updownarrow 8.8cm \leftrightarrow 11.5cm

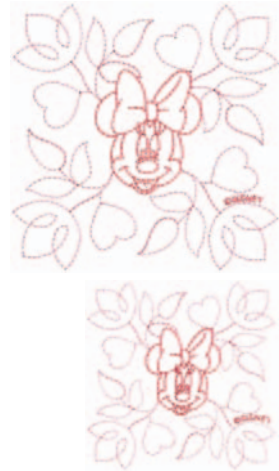

- No.27** 4min/3min
- 1 (133)
 - 2 (155)
- L: \updownarrow 12.5cm \leftrightarrow 12.5cm
S: \updownarrow 9.0cm \leftrightarrow 9.0cm
- COUNTRY (COUNTRY)

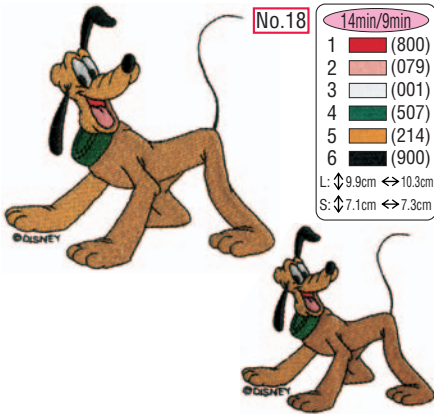

- No.18** 14min/9min
- 1 (800)
 - 2 (079)
 - 3 (001)
 - 4 (507)
 - 5 (214)
 - 6 (900)
- L: \updownarrow 9.9cm \leftrightarrow 10.3cm
S: \updownarrow 7.1cm \leftrightarrow 7.3cm



- No.22** 7min/4min
- 1 (800)
 - 2 (900)
- L: \updownarrow 1.7cm \leftrightarrow 8.8cm
S: \updownarrow 1.3cm \leftrightarrow 6.3cm



- No.23** 7min/4min
- 1 (800)
 - 2 (900)
- L: \updownarrow 1.8cm \leftrightarrow 8.9cm
S: \updownarrow 1.3cm \leftrightarrow 6.4cm

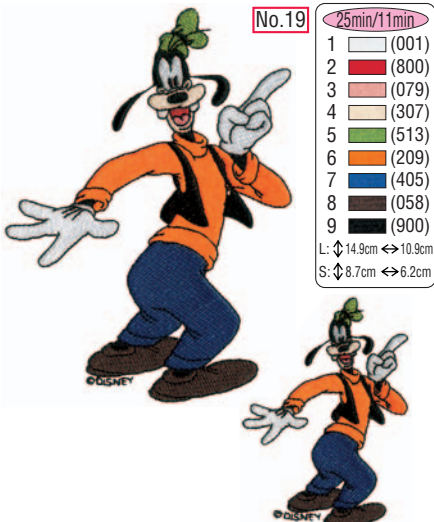

- No.19** 25min/11min
- 1 (001)
 - 2 (800)
 - 3 (079)
 - 4 (307)
 - 5 (513)
 - 6 (209)
 - 7 (405)
 - 8 (058)
 - 9 (900)
- L: \updownarrow 14.9cm \leftrightarrow 10.9cm
S: \updownarrow 8.7cm \leftrightarrow 6.2cm

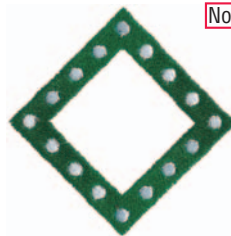

- No.24** 12min
- 1 (507)
 - 2 (001)
- \updownarrow 8.7cm \leftrightarrow 8.7cm



- No.25** 12min
- 1 (900)
 - 2 (001)
- \updownarrow 7.5cm \leftrightarrow 7.5cm



- No.28** 4min/3min
- 1 (442)
 - 2 (444)
- L: \updownarrow 12.6cm \leftrightarrow 12.6cm
S: \updownarrow 8.9cm \leftrightarrow 8.9cm
- COUNTRY (COUNTRY)

No.29 4min/3min

1 (152)
2 (624)

L: 12.6cm ↔ 12.6cm
S: 9.0cm ↔ 9.1cm

COUNTRY

No.33 3min

1 (019)
2 (007)

2.4cm ↔ 2.4cm

No.34 3min

1 (001)
2 (800)
3 (019)

2.4cm ↔ 2.4cm

No.39 54min

1 (205)
2 (900)
3 (001)
4 (800)
5 (900)
6 (800)
7 (900)
8 (001)
9 (205)
10 (800)
11 (900)
12 (001)
13 (800)
14 (900)
15 (001)
16 (900)

18.8cm ↔ 15.6cm

No.30 3min

1 (224)
2 (255)

8.7cm ↔ 8.7cm

COUNTRY

No.35 3min

1 (019)
2 (007)
3 (800)
4 (001)

2.4cm ↔ 2.4cm

★ **No.40** 20min

1 ---x (001)
2 ---- (001)
3 wvv (001)
4 (800)
5 (900)

10.7cm ↔ 12.4cm

No.31 3min

1 (322)
2 (264)

9.0cm ↔ 9.0cm

COUNTRY

No.36 3min

1 (017)
2 (010)
3 (209)
4 (205)

2.5cm ↔ 2.4cm

★ **No.41** 26min

1 ---x (001)
2 ---- (001)
3 wvv (001)
4 (214)
5 (800)
6 (900)
7 (205)

11.7cm ↔ 12.6cm

No.32 1min

1 (485)
2 (149)

1.5cm ↔ 4.1cm

COUNTRY

No.37 3min

1 (086)
2 (209)

2.5cm ↔ 2.4cm

No.42 7min/4min

1 (001)
2 (800)
3 (900)

L: 5.0cm ↔ 5.6cm
S: 3.9cm ↔ 4.0cm

No.38 3min

1 (614)
2 (086)

2.5cm ↔ 2.4cm

No.43 9min/5min

1 (001)
2 (214)
3 (800)
4 (205)
5 (900)

L: 5.6cm ↔ 5.8cm
S: 4.3cm ↔ 4.1cm



No.44 7min

1	White	(001)
2	Orange	(214)
3	Red	(800)
4	Yellow	(205)
5	Black	(900)
6	White	(001)

↓5.8cm ↔3.9cm

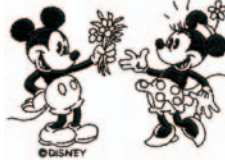

No.48 7min

1	Black	(900)
2	White	(001)

↓6.0cm ↔8.5cm



No.53 64min

1	Orange	(214)
2	Black	(900)
3	Red	(800)
4	Black	(900)
5	Orange	(214)
6	Black	(900)

↓25.6cm ↔13.6cm



No.45 6min

1	White	(001)
2	Orange	(214)
3	Red	(800)
4	Black	(900)
5	White	(001)

↓5.5cm ↔3.6cm

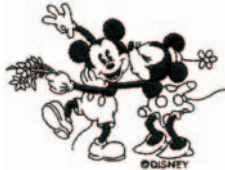

No.49 6min

1	Black	(900)
---	-------	-------

↓6.2cm ↔8.6cm



No.46 27min/11min

1	White	(001)
2	Red	(800)
3	Orange	(214)
4	Black	(900)

L: ↓13.5cm ↔11.0cm
S: ↓7.9cm ↔6.3cm

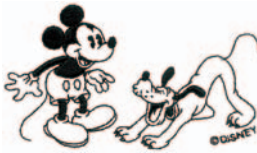

No.50 5min

1	Black	(900)
---	-------	-------

↓5.4cm ↔9.6cm



No.51 3min

1	Brown	(224)
2	Dark Brown	(706)

↓12.5cm ↔12.5cm



COUNTRY

No.54 66min

1	Blue	(070)
2	Orange	(209)
3	Purple	(620)
4	Yellow	(307)
5	Light Yellow	(010)
6	Purple	(612)
7	White	(001)
8	Black	(900)
9	Orange	(209)
10	Light Yellow	(010)
11	Light Yellow	(124)
12	Black	(900)
13	Brown	(339)
14	Blue	(070)
15	Pink	(085)
16	Red	(107)
17	Black	(900)
18	Orange	(214)
19	Red	(800)
20	Blue	(070)
21	Brown	(323)
22	Brown	(339)
23	Red	(107)
24	Pink	(079)
25	Black	(900)
26	Purple	(612)
27	Blue	(019)
28	Red	(086)
29	Black	(900)
30	Red	(086)
31	Light Yellow	(124)
32	Pink	(085)
33	Red	(107)
34	Brown	(339)
35	Black	(900)

↓20.8cm ↔15.6cm

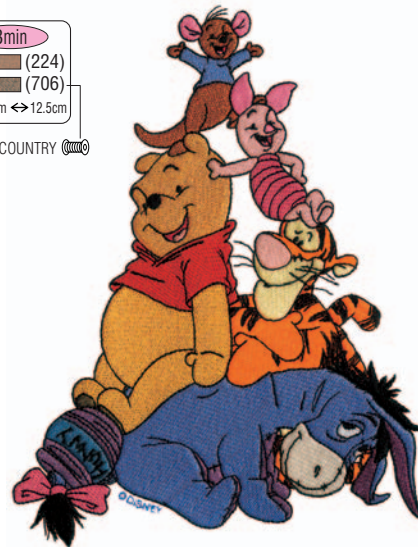

No.47 30min/13min

1	White	(001)
2	Red	(800)
3	Yellow	(205)
4	Orange	(214)
5	Black	(900)
6	White	(001)

L: ↓14.0cm ↔10.2cm
S: ↓8.3cm ↔5.9cm



No.52 3min

1	Brown	(224)
2	Dark Brown	(706)

↓12.5cm ↔12.5cm



COUNTRY



No.55 19min

1	Orange	(335)
2	Light Orange	(370)
3	Light Orange	(354)
4	White	(000)
5	Black	(100)
6	Red	(212)
7	Red	(158)
8	Red	(126)

↓7.4cm ↔6.6cm

COUNTRY

No.56 3min/2min



1 (214)
2 (107)
3 (900)

L: \updownarrow 3.7cm \leftrightarrow 2.8cm
S: \updownarrow 2.8cm \leftrightarrow 2.0cm

No.62 14min/7min



1 (010)
2 (124)
3 (209)
4 (900)

L: \updownarrow 8.6cm \leftrightarrow 5.7cm
S: \updownarrow 5.1cm \leftrightarrow 3.4cm

No.67 10min



1 (085)
2 (339)
3 (900)

\updownarrow 8.1cm \leftrightarrow 6.6cm

No.57 3min/2min



1 (085)
2 (124)
3 (107)
4 (900)

L: \updownarrow 3.8cm \leftrightarrow 2.7cm
S: \updownarrow 2.8cm \leftrightarrow 2.0cm

No.63 12min



1 (019)
2 (214)
3 (800)
4 (323)
5 (900)

\updownarrow 9.6cm \leftrightarrow 5.7cm

No.68 28min



1 (010)
2 (107)
3 (214)
4 (209)
5 (124)
6 (800)
7 (323)
8 (900)

\updownarrow 9.3cm \leftrightarrow 11.0cm

No.58 3min/2min



1 (010)
2 (107)
3 (209)
4 (124)
5 (900)

L: \updownarrow 3.4cm \leftrightarrow 3.4cm
S: \updownarrow 2.5cm \leftrightarrow 2.5cm

No.64 5min



1 (085)
2 (124)
3 (086)
4 (405)
5 (070)
6 (900)

\updownarrow 5.8cm \leftrightarrow 3.0cm

No.69 22min



1 (214)
2 (070)
3 (507)
4 (323)
5 (058)
6 (339)
7 (800)
8 (107)
9 (405)
10 (010)
11 (900)

\updownarrow 9.6cm \leftrightarrow 7.3cm

No.59 5min/4min



1 (001)
2 (620)
3 (307)
4 (070)
5 (900)

L: \updownarrow 4.4cm \leftrightarrow 4.0cm
S: \updownarrow 3.2cm \leftrightarrow 2.9cm

No.60 12min/6min



1 (214)
2 (323)
3 (800)
4 (900)

L: \updownarrow 8.7cm \leftrightarrow 4.7cm
S: \updownarrow 5.3cm \leftrightarrow 2.7cm

No.65 20min



1 (001)
2 (307)
3 (005)
4 (086)
5 (620)
6 (612)
7 (070)
8 (900)

\updownarrow 7.8cm \leftrightarrow 7.9cm

No.70 48min



1 (001)
2 (612)
3 (307)
4 (085)
5 (124)
6 (086)
7 (010)
8 (620)
9 (070)
10 (209)
11 (107)
12 (058)
13 (513)
14 (205)
15 (030)
16 (420)
17 (339)
18 (900)

\updownarrow 16.5cm \leftrightarrow 11.5cm

No.61 4min/2min



1 (085)
2 (124)
3 (086)
4 (900)

L: \updownarrow 5.8cm \leftrightarrow 2.8cm
S: \updownarrow 3.5cm \leftrightarrow 1.7cm

No.66 4min



1 (800)
2 (205)
3 (507)
4 (085)
5 (070)
6 (339)
7 (900)

\updownarrow 3.5cm \leftrightarrow 4.6cm

No.71 5min



1 (323)

\updownarrow 9.1cm \leftrightarrow 5.6cm



No.72

3min
1 (323)
↓7.4cm ↔3.3cm



No.78

19min
1 (010)
2 (107)
3 (209)
4 (124)
5 (800)
6 (323)
7 (214)
8 (900)
9 (507)
10 (513)
↓7.4cm ↔9.6cm



No.83

1min
1 (334)
2 (354)
↓5.7cm ↔5.7cm
COUNTRY



No.73

9min
1 (323)
↓11.1cm ↔5.1cm



No.79

11min
1 (208)
2 (208)
3 (208)
4 (017)
5 (019)
6 (513)
7 (205)
↓8.9cm ↔9.6cm

me and my buddies

No.84

1min
1 (900)
↓1.2cm ↔7.8cm



No.74

7min
1 (323)
↓9.5cm ↔6.4cm



No.80

1min
1 (334)
2 (354)
↓7.5cm ↔12.5cm
COUNTRY

A friendly day indeed.

No.85

1min
1 (900)
↓2.1cm ↔9.4cm



No.75

7min
1 (323)
↓7.9cm ↔9.6cm



No.81

3min
1 (334)
2 (354)
↓12.4cm ↔13.4cm
COUNTRY



No.86

4min
1 (502)
2 (010)
3 (001)
4 (214)
5 (019)
↓3.2cm ↔3.2cm



No.76

1min
1 (323)
↓1.8cm ↔6.5cm



No.87

4min
1 (017)
2 (010)
3 (019)
↓3.2cm ↔3.2cm

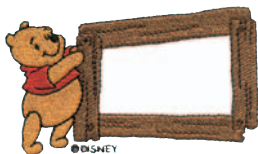

No.77

15min
1 (323)
2 (214)
3 (800)
4 (058)
5 (900)
↓5.5cm ↔9.6cm



No.82

4min
1 (334)
2 (354)
↓12.7cm ↔12.7cm
COUNTRY



No.88

4min
1 (205)
2 (502)
3 (214)
4 (019)
↓3.2cm ↔3.2cm



No.89

15min

- 1 (307)
 - 2 (208)
 - 3 (205)
 - 4 (001)
 - 5 (107)
 - 6 (086)
 - 7 (019)
 - 8 (405)
 - 9 (086)
 - 10 (900)
 - 11 (001)
 - 12 (507)
 - 13 (107)
- ↓9.9cm ↔5.6cm



No.94

39min

- 1 (214)
 - 2 (001)
 - 3 (307)
 - 4 (010)
 - 5 (405)
 - 6 (058)
 - 7 (323)
 - 8 (085)
 - 9 (843)
 - 10 (339)
 - 11 (205)
 - 12 (086)
 - 13 (900)
 - 14 (001)
- ↓12.2cm ↔9.4cm

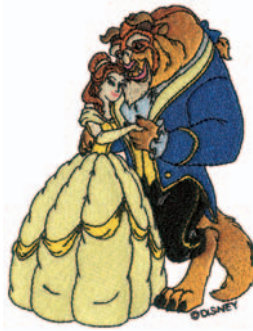

No.98

12min

- 1 (001)
 - 2 (307)
 - 3 (027)
 - 4 (017)
 - 5 (534)
 - 6 (502)
 - 7 (214)
 - 8 (030)
 - 9 (900)
 - 10 (001)
- ↓8.1cm ↔7.6cm



No.90

56min

- 1 (001)
 - 2 (307)
 - 3 (612)
 - 4 (328)
 - 5 (208)
 - 6 (513)
 - 7 (339)
 - 8 (900)
 - 9 (323)
 - 10 (328)
 - 11 (001)
 - 12 (208)
 - 13 (307)
 - 14 (513)
 - 15 (612)
 - 16 (339)
 - 17 (900)
- ↓11.6cm ↔14.1cm



No.95

14min

- 1 (086)
 - 2 (085)
 - 3 (001)
 - 4 (507)
 - 5 (307)
 - 6 (205)
 - 7 (214)
 - 8 (323)
 - 9 (800)
 - 10 (085)
 - 11 (058)
- ↓10.8cm ↔6.2cm



No.99

13min

- 1 (001)
 - 2 (010)
 - 3 (124)
 - 4 (614)
 - 5 (339)
 - 6 (107)
 - 7 (900)
 - 8 (323)
- ↓10.9cm ↔5.3cm



No.91

18min

- 1 (307)
 - 2 (205)
 - 3 (017)
 - 4 (001)
 - 5 (019)
 - 6 (086)
 - 7 (007)
- ↓9.9cm ↔8.1cm



No.96

24min

- 1 (307)
 - 2 (005)
 - 3 (900)
 - 4 (017)
 - 5 (405)
 - 6 (085)
 - 7 (086)
 - 8 (502)
 - 9 (534)
 - 10 (058)
 - 11 (208)
- ↓8.0cm ↔9.1cm



No.101

8min

- 1 (017)
 - 2 (019)
 - 3 (307)
 - 4 (502)
 - 5 (001)
 - 6 (205)
 - 7 (086)
 - 8 (900)
- ↓8.5cm ↔4.9cm



No.92

10min

- 1 (001)
 - 2 (307)
 - 3 (502)
 - 4 (507)
 - 5 (612)
 - 6 (086)
 - 7 (030)
 - 8 (007)
- ↓6.9cm ↔7.8cm



No.97

16min

- 1 (001)
 - 2 (307)
 - 3 (019)
 - 4 (085)
 - 5 (205)
 - 6 (086)
 - 7 (058)
 - 8 (900)
- ↓8.1cm ↔8.6cm



No.102

25min

- 1 (017)
 - 2 (810)
 - 3 (620)
 - 4 (001)
 - 5 (208)
 - 6 (307)
 - 7 (704)
 - 8 (800)
 - 9 (214)
 - 10 (323)
 - 11 (900)
 - 12 (001)
- ↓14.2cm ↔7.7cm





No.103

11min

1	(515)
2	(513)
3	(058)
4	(214)
5	(001)
6	(307)
7	(030)
8	(339)
9	(507)
10	(900)

↓10.3cm ↔ 4.4cm



No.108

15min

1	(843)
2	(001)
3	(323)
4	(405)
5	(010)
6	(513)
7	(208)
8	(086)
9	(900)
10	(001)

↓6.3cm ↔ 5.8cm



No.112

25min

1	(001)
2	(339)
3	(843)
4	(307)
5	(030)
6	(323)
7	(900)

↓10.0cm ↔ 8.7cm



No.104

7min

1	(001)
2	(205)
3	(323)
4	(800)
5	(027)
6	(019)
7	(058)

↓5.4cm ↔ 4.2cm



No.109

33min

1	(124)
2	(001)
3	(800)
4	(019)
5	(208)
6	(900)

↓12.5cm ↔ 10.4cm

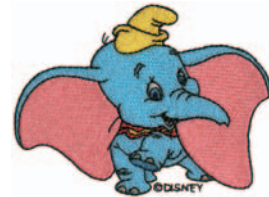

No.113

20min

1	(005)
2	(001)
3	(019)
4	(205)
5	(079)
6	(017)
7	(800)
8	(124)
9	(900)

↓7.2cm ↔ 9.7cm



No.105

14min

1	(001)
2	(019)
3	(800)
4	(307)
5	(010)
6	(208)
7	(019)
8	(339)
9	(058)

↓9.6cm ↔ 5.0cm



No.110

25min

1	(843)
2	(010)
3	(001)
4	(085)
5	(323)
6	(339)
7	(704)
8	(800)
9	(070)
10	(086)
11	(515)
12	(058)

↓9.2cm ↔ 9.5cm



No.114

18min

1	(010)
2	(323)
3	(843)
4	(328)
5	(079)
6	(900)
7	(339)
8	(323)
9	(010)
10	(214)
11	(079)
12	(900)

↓5.7cm ↔ 9.6cm



No.106

13min

1	(001)
2	(079)
3	(010)
4	(339)
5	(323)
6	(214)
7	(058)
8	(900)

↓9.6cm ↔ 5.4cm

No.111

19min

1	(001)
2	(843)
3	(079)
4	(704)
5	(307)
6	(214)
7	(339)
8	(019)
9	(328)
10	(058)

↓9.6cm ↔ 6.9cm



No.115

47min

1	(058)
2	(010)
3	(323)
4	(339)
5	(214)
6	(079)
7	(086)
8	(001)
9	(900)

↓11.7cm ↔ 11.7cm



No.107

19min

1	(001)
2	(079)
3	(010)
4	(323)
5	(339)
6	(214)
7	(058)
8	(900)
9	(001)
10	(124)
11	(843)
12	(704)
13	(339)
14	(513)
15	(010)
16	(208)
17	(086)
18	(900)

↓7.8cm ↔ 10.0cm



No.116 23min

1 (810)
2 (001)
3 (010)
4 (070)
5 (017)
6 (019)
7 (208)
8 (019)

↓4.9cm ↔14.6cm

No.121 12min

1 (010)
2 (017)
3 (208)
4 (124)
5 (085)
6 (010)
7 (017)
8 (124)
9 (085)
10 (208)
11 (027)
12 (502)

↓2.3cm ↔11.6cm

No.126 29min

1 (810)
2 (001)
3 (085)

↓19.4cm ↔11.6cm

No.117 5min

1 (612)
2 (620)
3 (502)
4 (534)
5 (620)
6 (612)
7 (017)

↓2.2cm ↔9.4cm

No.122 6min

1 (010)
2 (017)
3 (208)
4 (124)
5 (085)
6 (027)
7 (502)

↓5.6cm ↔3.8cm

No.118 4min

1 (612)
2 (620)
3 (502)
4 (534)
5 (620)
6 (612)
7 (017)

↓5.1cm ↔5.4cm

No.127 15min

1 (001)
2 (010)
3 (208)

↓18.0cm ↔10.6cm

No.123 11min

1 (001)
2 (017)
3 (205)
4 (070)

↓3.1cm ↔13.5cm

No.119 7min

1 (307)
2 (010)
3 (017)
4 (070)
5 (124)
6 (085)
7 (086)
8 (027)
9 (502)

↓2.6cm ↔8.1cm

No.128 4min

1 (620)

↓12.6cm ↔13.0cm

No.124 2min

1 (323)

↓3.8cm ↔6.9cm

No.120 7min

1 (027)
2 (502)
3 (010)
4 (307)
5 (208)
6 (017)
7 (085)
8 (086)
9 (070)
10 (086)

↓3.0cm ↔7.4cm

No.129 8min

1 (339)

↓15.7cm ↔14.0cm

No.125 4min

1 (323)

↓4.3cm ↔11.5cm

Examples of Combinations
Exemples de combinaisons
Esempi di combinazioni

Kombinationsbeispiele
Voorbeelden van combinaties
Ejemplos de combinaciones

Using the various patterns in combination will expand your world of enjoyment.

Durch die Verwendung der verschiedenen Muster und deren Kombinationen werden die Anwendungsmöglichkeiten stark erweitert.

En utilisant les différents motifs en combinaisons, vous aurez encore plus de plaisir à coudre.

Het in combinatie gebruiken van de verschillende patronen bidet vele leuke nieuwe mogelijkheden.

L'uso dei vari disegni in combinazione fra loro espande esponenzialmente le possibilità di divertirsi cucendo.

Usando diferentes patrones combinados podrá expandir el mundo de diversión.

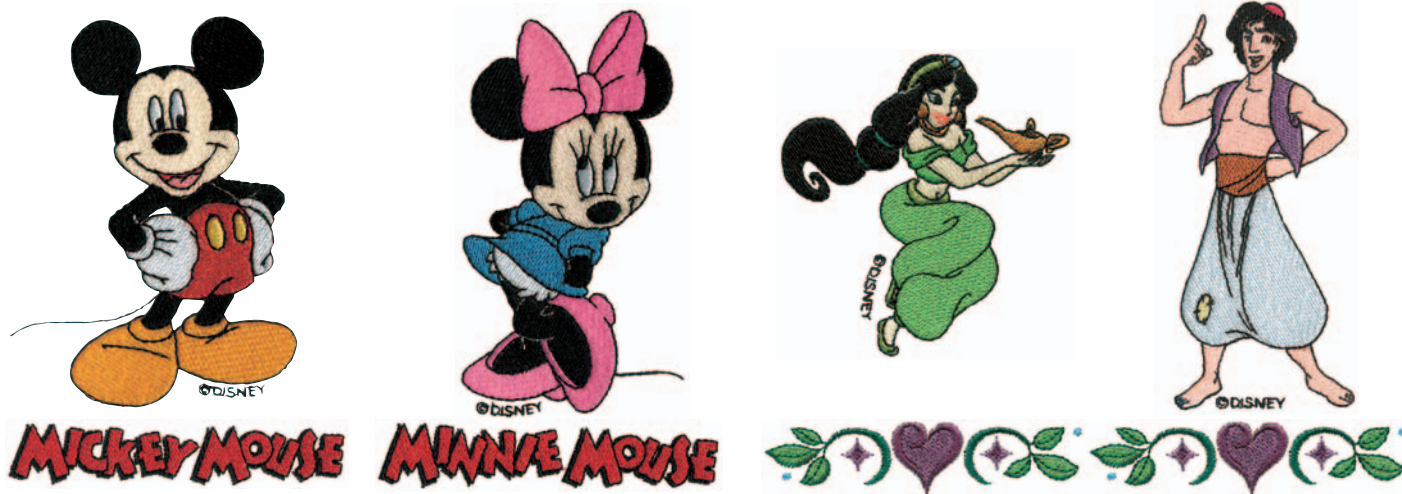
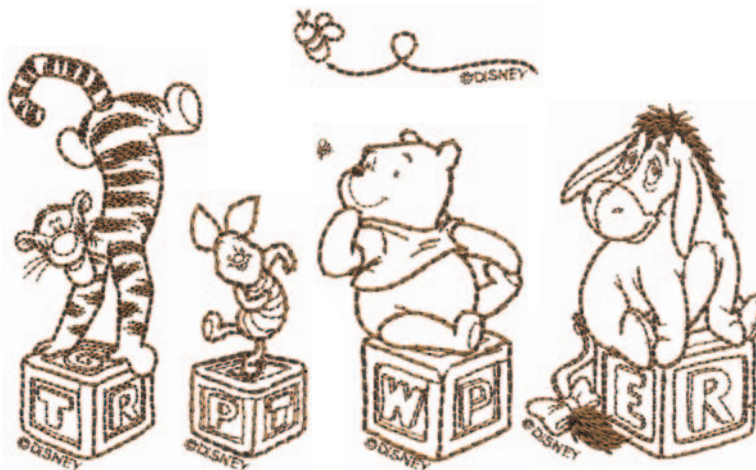

- The products in this guide are creations of Brother Industries (K.K.) using the Disney Copyright under contract with Walt Disney Enterprises (Inc.).
- Die Vorlagen in dieser Anleitung wurden von Brother Industries entworfen. Die Verwendung der Urheberrechte wurden vertraglich von Walt Disney Enterprises Inc. erlaubt.
- Les produits décrits dans ce guide ont été créés par Brother Industries (K.K.) en utilisant les droits d'auteur de Disney sous contrat de Walt Disney Enterprises (Inc.).
- De producten in deze gids zijn creaties van Brother Industries (K.K.) met gebruikmaking van het Disney Copyright onder contract van Walt Disney Enterprises (Inc.).
- I prodotti in questa guida sono stati creati da Brother Industries (K.K.) utilizzando i diritti di Copyright Disney conformemente al contratto con Walt Disney Enterprises (Inc.).
- Los productos en este guía son creaciones de Brother Industries (K.K.) que usan los derechos de autor de Disney mediante contrato con Walt Disney Enterprises (Inc.).

