

# **Innov-ís 4000D/4000 PREMIUM PACKAGE**

## **Version 3.0 Upgrade Kit Operation Manual**

Before using this upgrade kit, be sure to read this Operation Manual for information on its correct use.

---

# CONTENTS

Before You Start.....	2
New Features.....	2
Screens Operations Performed Using a USB Mouse.....	3
Clicking a key .....	3
Changing pages .....	4
Moving embroidery patterns .....	5
Selecting combined embroidery patterns .....	6
Reducing Character Spacing.....	6
Color Sorting Repeated Patterns.....	7
Pivoting .....	8
Automatic Fabric Sensor System (Automatic Presser Foot Pressure).....	9
Free-motion Quilting .....	10
Using Free-motion Quilting Foot “C” .....	10
Using Free-motion Open Toe Quilting Foot “O” .....	11
Echo Quilting Using the Free-motion Echo Quilting Foot “E” .....	12
Returning to the Beginning of the Pattern.....	14
Measurements on the Bobbin Cover .....	15

---

## Before You Start

---

It is important to remember to perform the upgrade according to the Installation Guide. The machine can then be used as described in the Operation Manual. New machine features and benefits are described in this Operation Manual.

---

## New Features

---

The following features will be added with the upgrade to version 3.0.

- Screens operations can be performed using a USB mouse.
- A USB hub can be used.
- A pivot function has been added for easily changing the sewing direction. ( **Utility Stitch** or **Character Decorative Stitch** )
- A function for detecting the fabric thickness and automatically adjusting the presser foot pressure while sewing has been added. ( **Utility Stitch** or **Character Decorative Stitch** )
- A function for adjusting the presser foot to the most suitable height during free-motion quilting has been added. ( **Utility Stitch** or **Character Decorative Stitch** )
- A function for easily returning to the beginning of the pattern after trial sewing has been added. ( **Character Decorative Stitch** )
- Embroidery patterns can be moved by dragging them to the desired position. ( **Embroidery** or **Embroidery Edit** )
- The function for adjusting the character spacing has been improved. ( **Embroidery Edit** )
- The sewing order of border patterns can be changed so the same color is continuously sewn in each repeated pattern. ( **Embroidery Edit** )

## Screens Operations Performed Using a USB Mouse

If a USB mouse (sold separately by computer retailers) is connected to the sewing machine, the mouse can be used to perform operations in the screens. In addition, a USB hub can be connected so that USB media and a USB mouse can be used at the same time.

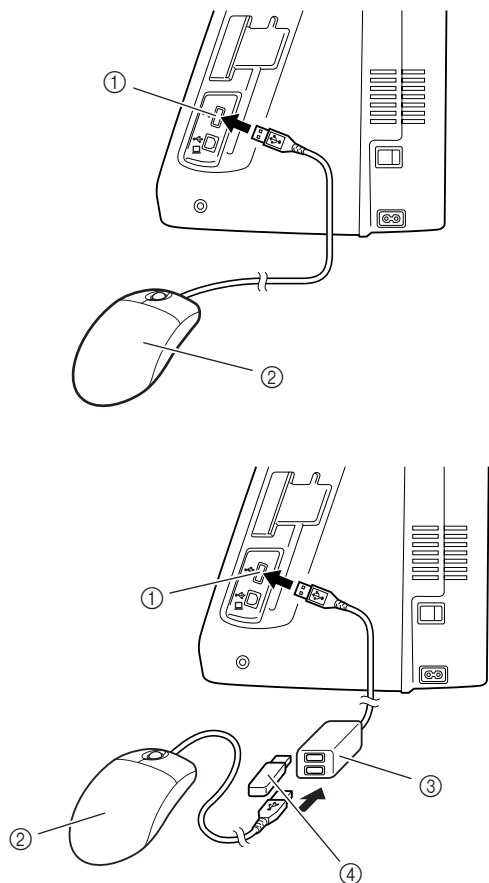

- ① USB port connector for media
- ② USB mouse
- ③ USB hub
- ④ USB media

### Note

- Some mouse types cannot be used to operate the machine. For details on the USB mouse types that are compatible, check [www.brother.com](http://www.brother.com).
- A USB mouse and USB hub can be connected or disconnected at any time.
- Only the left mouse button and its wheel can be used to perform operations. No other buttons can be used.
- Do not insert two or more USB media into a USB hub. Only one USB media can be recognized.

## Clicking a key

When the mouse is connected, the pointer appears in the screen. Move the mouse to position the pointer over the desired key, and then click the left mouse button.

### Memo

- Double-clicking has no effect.

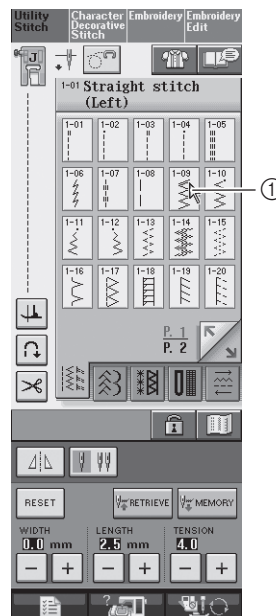



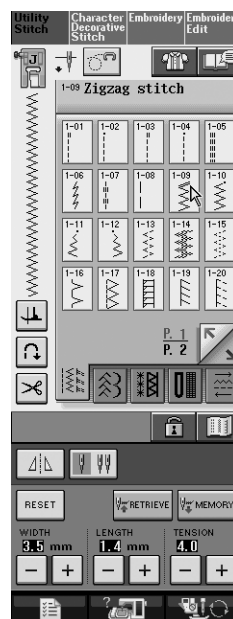
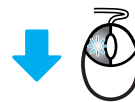

① Pointer



## ■ Changing pages

Rotate the mouse wheel to switch through the tabs of the pattern selection screens.

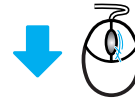
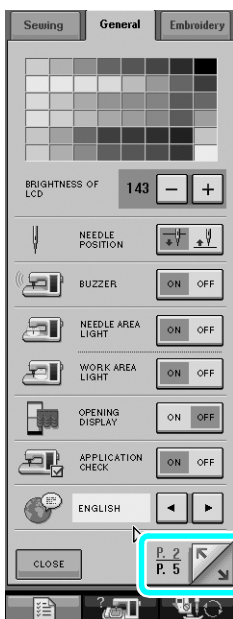
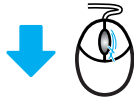
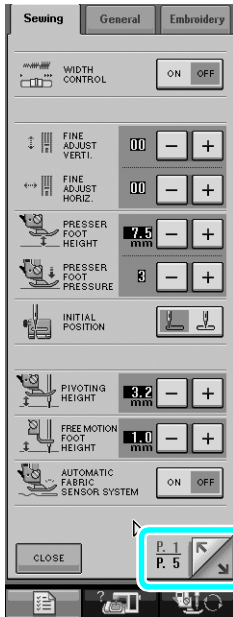

### Memo

- If  for additional pages is displayed, rotate the mouse wheel to display the next page. In the  or , click the left mouse button with the pointer on  or  to move down to the next part of a page.



## ■ Moving embroidery patterns

In the Embroidery and Embroidery Edit screens, patterns can be moved by dragging them to the desired position.



- 1 Select a pattern.
- 2 Press  or  to display the editing screen.
- 3 Move the mouse to position the pointer over the desired pattern, and then drag the pattern to the desired position. In addition, patterns can be dragged to their desired positions by directly touching the screen with your finger or touch pen.

### Memo

- Patterns cannot be moved in screens where



does not appear.

- If  in the Embroidery Edit screen is pressed to display an enlargement of the pattern, the pattern cannot be moved by dragging it. Press  in the screen to move the pattern.

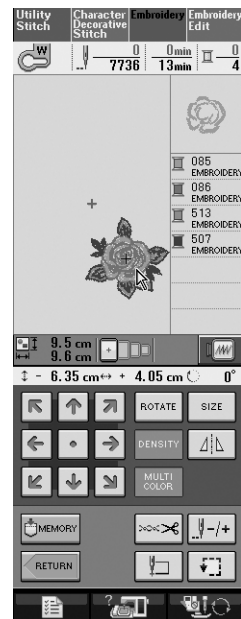
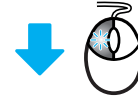
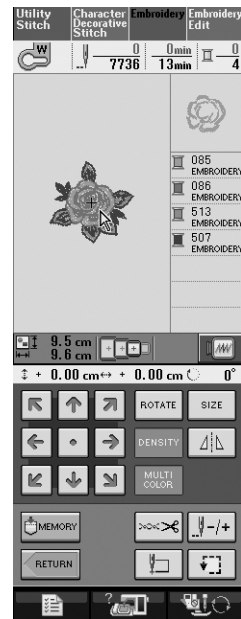

## ■ Selecting combined embroidery patterns

When patterns are combined in the Embroidery Edit screen, patterns can be selected by clicking them. Move the mouse to position the pointer over the desired pattern, and then click the left mouse button. In addition, patterns can be selected by directly touching the screen with your finger or touch pen.

### Memo

- If a pattern that is overlapping cannot be selected, touch  in the screen to select it.

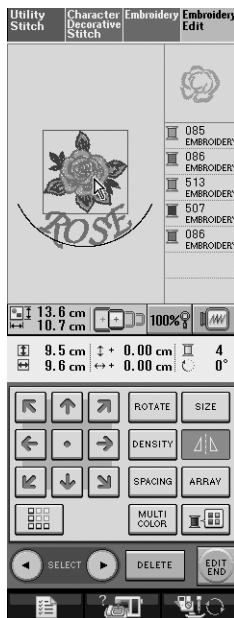
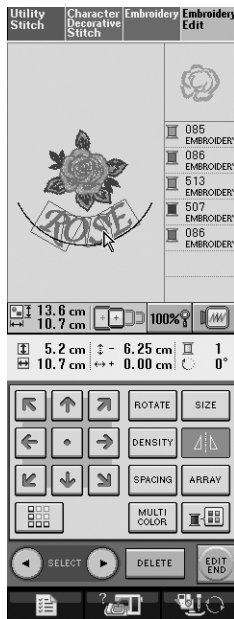

## Reducing Character Spacing

In the Embroidery Edit screen, the spacing between characters can be reduced to 50% of the narrowest character in the group.

### Note

- It is not recommended to edit data and transfer to other or older version machines. Same features do not apply in other machines, so problems may occur.
- Character spacing can be reduced only when characters are arranged normally on a straight line.

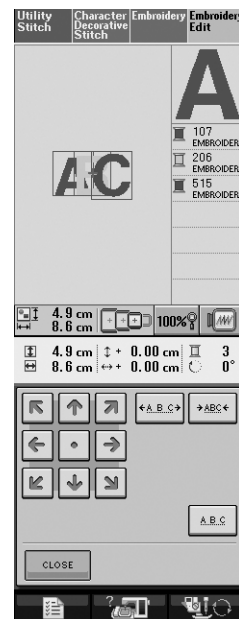
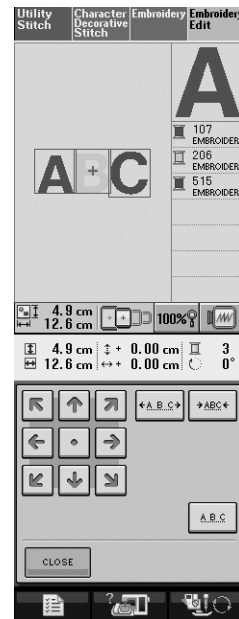

## Color Sorting Repeated Patterns

The sewing order of combined border embroidery patterns in the Embroidery Edit screen can be automatically changed so that the same color can be continuously sewn in each pattern that is repeated. This allows you to continue sewing without repeatedly changing the upper thread or changing the sewing order manually.

### Memo

- In combined stitch patterns that contain two or more border patterns or other patterns combined with border patterns, the sewing order of only the border patterns is changed.
- When a group of two or more patterns using border patterns is repeated, the sewing order is changed so that the same color can be sewn continuously in each pattern.

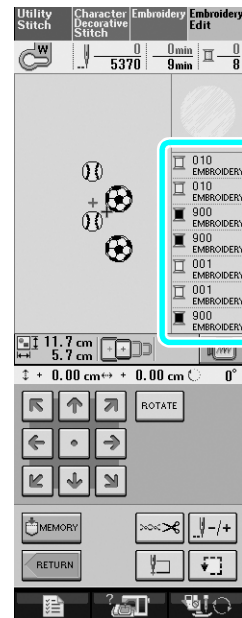
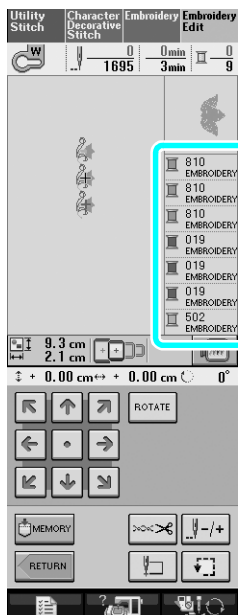
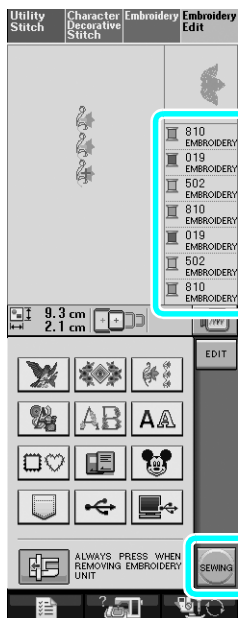





## Pivoting

If the pivot setting is selected, the machine stops with the needle lowered (in the fabric) and the presser foot is automatically raised to an appropriate height when the “Start/Stop” button is pressed. When the “Start/Stop” button is pressed again, the presser foot is automatically lowered and sewing continues. This function is useful for stopping the machine to rotate the fabric.

### CAUTION



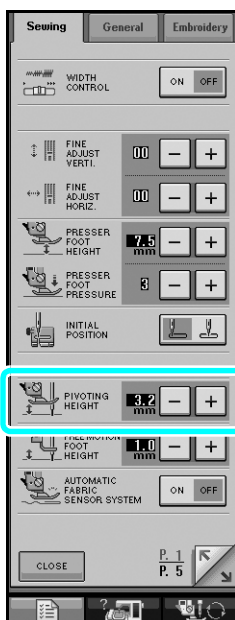

- When the pivot setting is selected, the machine starts when the “Start/Stop” button is pressed or the foot controller is pressed down even if the presser foot has been raised. Be sure to keep your hands and other items away from the needle, otherwise injuries may occur.

### Memo

When the pivot setting is selected, the height of the presser foot when sewing is stopped can be changed according to the type of fabric being sewn. Press  to display “PIVOTING HEIGHT” on P. 1 of the settings screen. Press  or  to select one of the three heights (3.2 mm, 5.0 mm or 7.5 mm). To raise the presser foot further, increase the setting. (Normally, 3.2 mm is set.)



### Note

- The “NEEDLE POSITION” (P. 2 of the settings screen) must be set in the down position for the pivot function to be used. When “NEEDLE POSITION” is set in the raised position,  appears as light gray and cannot be used.
- When the setting is selected, the pivot function can only be used with stitches where presser foot J or N is indicated in the upper-left corner of the screen. If any other stitch is selected,  appears as light gray and is not available.
- Since the presser foot is fully raised when the automatic thread cutting key is pressed, press the “Presser Foot Lifter” button to lower the presser foot, and then press the “Start/Stop” button to continue sewing.
- If the pivot setting is selected,  and  beside “PRESSER FOOT HEIGHT” in the settings screen are not available and the setting cannot be changed.

- 1 Select a stitch.
- 2 Press  to select the pivot setting.

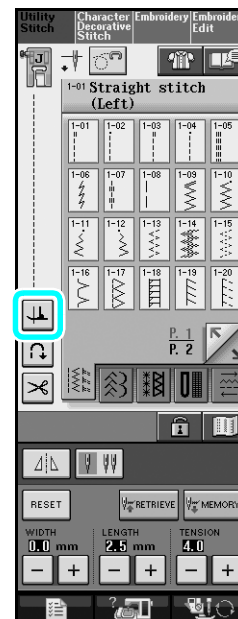

→ The key appears as .

- 3** Place the fabric under the presser foot with the needle at the starting point of the stitching, and then press the “Start/Stop” button. The machine will begin sewing.

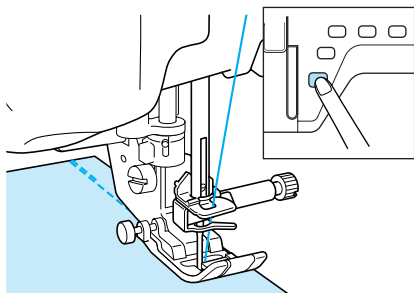

**Memo**

If you press the “Start/Stop” button to pause sewing, then press it again to continue, reverse stitches (or reinforcement stitches) will not be sewn.

- 4** Press the “Start/Stop” button to stop the machine at the point where the sewing direction changes.

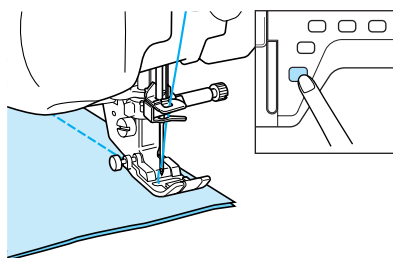

→ The machine stops with the needle in the fabric, and the presser foot is raised.

- 5** Rotate the fabric, and then press the “Start/Stop” button.

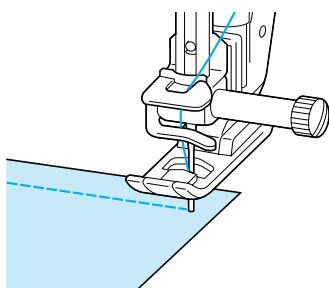

→ The presser foot is automatically lowered, and sewing continues.

## Automatic Fabric Sensor System (Automatic Presser Foot Pressure)

The thickness of the fabric is automatically detected and the presser foot pressure is automatically adjusted with an internal sensor while sewing, so your fabric is fed smoothly. The fabric sensor system works continuously while sewing. This function is useful for sewing over thick seams, or quilting.

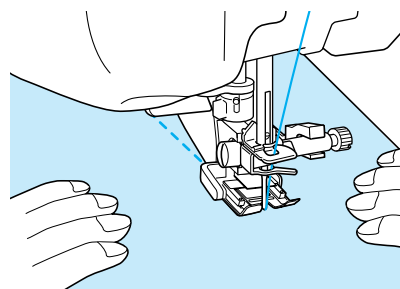
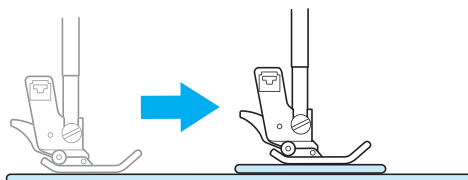

- 1** Press .

→ The settings screen appears.

- 2** Set “AUTOMATIC FABRIC SENSOR SYSTEM” to “ON”.



- 3** Press  to return to the original screen.

## Free-motion Quilting

For free-motion quilting, use free-motion quilting foot “C” or free-motion open toe quilting foot “O” depending on the stitch that is selected, and set the machine to free-motion sewing mode. In this mode, the presser foot is raised to the necessary height for free-motion sewing.

We recommend attaching the foot controller and sewing at a consistent speed. You can adjust the sewing speed with the speed control slide on the machine.

### ■ Using Free-motion Quilting Foot “C”

The free-motion quilting foot “C” is used for free-motion sewing using the straight stitch needle plate.



Free-motion quilting foot “C”

### ⚠ CAUTION

- With free-motion quilting, control the feeding speed of the fabric to match the sewing speed. If the fabric is moved faster than the sewing speed, the needle may break or other damage may result.
- When using free-motion quilting foot “C”, be sure to use the straight stitch needle plate and sew with the needle in middle (center) needle position. If the needle is moved to any position other than the middle (center) needle position, the needle may break, which may result in injuries.

### 📖 Memo

- When starting to sew, the internal sensor detects the thickness of the fabric, and the quilting foot is raised to the height specified in the machine settings screen. Press to display “FREE MOTION FOOT HEIGHT” on P. 1 of the settings screen. Press or to select the height that the quilting foot is raised. Increase the setting by pressing , for example, when sewing very stretchy fabric, so that it is easier to sew.



- In order to sew with a balanced tension, it may be necessary to adjust the upper thread tension. Test with a sample piece of fabric that is similar to your chosen fabric.

- 1 Follow steps on page 55 through 56 of the machine's Operation Manual to attach the straight stitch needle plate.

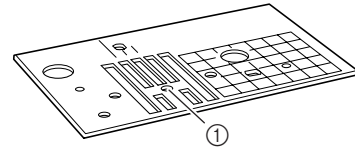

① Single hole

### 📖 Memo

Notice that this plate has a single hole.

- 2 Press to set the machine to free-motion sewing mode.

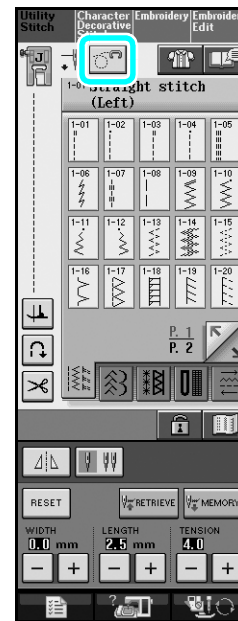

→ The key appears as , and the quilting foot is raised to the necessary height for free-motion sewing.

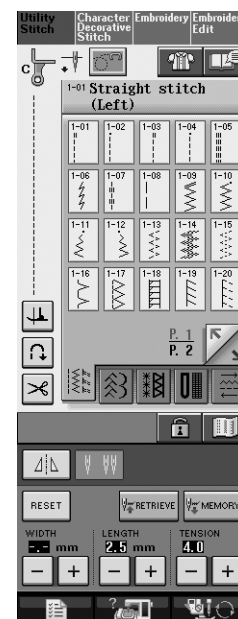

**3** Select any of the following stitches.

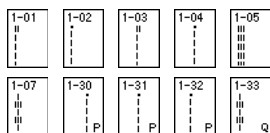

→ Free-motion quilting foot “C” is indicated in the upper-left corner of the screen.

**4** Remove the presser foot holder.

**5** Attach free-motion quilting foot “C” at the front with the presser foot holder screw aligned with the notch in the quilting foot.

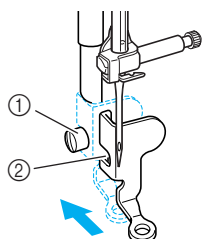

- ① Presser foot holder screw
- ② Notch



**Note**

Make sure that the quilting foot is attached properly and not slanted.

**6** Hold the quilting foot in place with your right hand, and tighten the presser foot holder screw using the screwdriver with your left hand.

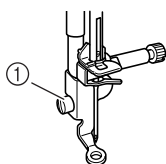

- ① Presser foot holder screw

**CAUTION**

- Be sure to securely tighten the screws with the screwdriver. Otherwise, the needle may touch the quilting foot, causing it to bend or break.

**7** Lower the feed dog position switch to **▲▲** to lower the feed dogs.

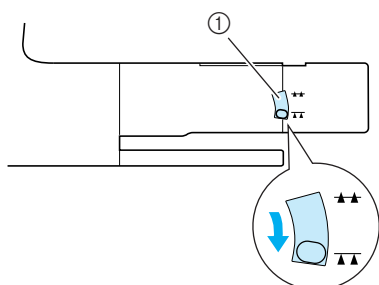

- ① Feed dog position switch

**8** Use both hands to stretch the fabric taut, and then move the fabric at a consistent pace in order to sew uniform stitches roughly 2.0-2.5 mm (approx. 1/16 - 3/32 inch) in length.

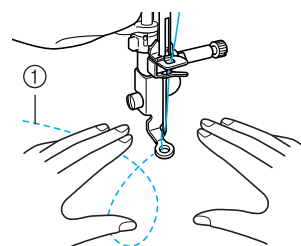

- ① Stitch

**9** Press  to cancel the free-motion sewing mode.



**Memo**

Do not be discouraged with your initial results. The technique requires practice.

**Using Free-motion Open Toe Quilting Foot “O”**

The free-motion open toe quilting foot “O” is used for free-motion quilting with zigzag or decorative stitches or for free-motion quilting of straight lines on fabric with an uneven thickness. Any stitch can be sewn with the free-motion open toe quilting foot “O”.

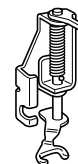

Free-motion open toe quilting foot “O”



**Note**

Free-motion open toe quilting foot “O” can also be used with the straight stitch needle plate. We recommend using free-motion open toe quilting foot “O” with free-motion sewing of fabrics of uneven thicknesses.



**Memo**

In order to sew with a balanced tension, it may be necessary to adjust the upper thread tension. Test with a sample piece of quilting fabric.

- 1 Press  to set the machine to free-motion sewing mode.

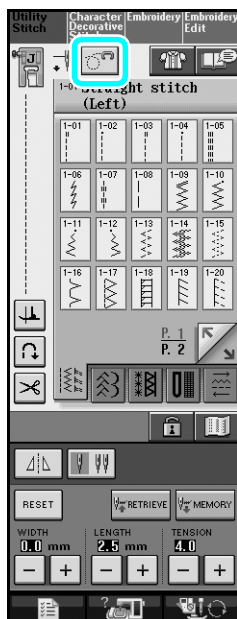

→ The key appears as , and the quilting foot is raised to the necessary height for free-motion sewing.

- 2 Select a stitch.

→ Free-motion open toe quilting foot "O" is indicated in the upper-left corner of the screen.

- 3 Remove the presser foot holder.

- 4 Attach free-motion open toe quilting foot "O" by positioning the pin of the quilting foot above the needle clamp screw and aligning the lower-left of the quilting foot and the presser bar.

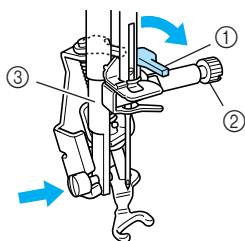

- 1 Pin
- 2 Needle clamp screw
- 3 Presser bar



#### Note

Make sure that the quilting foot is not slanted.

- 5 Hold the quilting foot in place with your right hand, and tighten the presser foot holder screw using the screwdriver with your left hand.

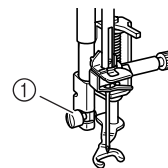

- 1 Presser foot holder screw

### CAUTION

- Be sure to securely tighten the screws with the screwdriver. Otherwise, the needle may touch the quilting foot, causing it to bend or break.

- 6 Use both hands to stretch the fabric taut, and then move the fabric at a consistent pace in order to sew uniform stitches roughly 2.0-2.5 mm (approx. 1/16 - 3/32 inch) in length.

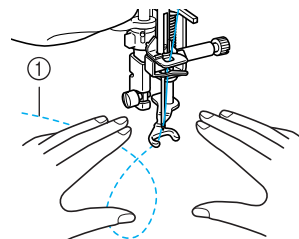

- 1 Stitch

- 7 Press  to cancel the free-motion sewing mode.



#### Memo

Do not be discouraged with your initial results. The technique requires practice.

## Echo Quilting Using the Free-motion Echo Quilting Foot "E"

Sewing quilting lines at equal distances around a motif is called echo quilting. The quilting lines, which appear as ripples echoing away from the motif, are the distinguishing characteristic of this quilting style. Use the free-motion echo quilting foot "E" for echo quilting. Using the measurement on the presser foot as a guide, sew around the motif at a fixed interval. We recommend attaching the foot controller and sewing at a consistent speed.

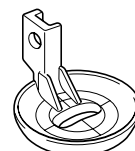

## Free-motion echo quilting foot “E” measurement

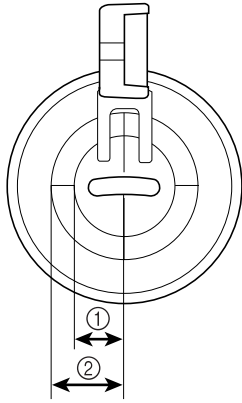





- ① 6.4 mm (approx. 1/4 inch)
- ② 9.5 mm (approx. 3/8 inch)

### CAUTION

- With free-motion quilting, control the feeding speed of the fabric to match the sewing speed. If the fabric is moved faster than the sewing speed, the needle may break or other damage may result.

### Memo

- When starting to sew, the internal sensor detects the thickness of the fabric, and the quilting foot is raised to the height specified in the machine settings screen. Press  to display “FREE MOTION FOOT HEIGHT” on P. 1 of the settings screen. Press  or  to select the height that the quilting foot is raised. Increase the setting by pressing , for example, when sewing very stretchy fabric, so that it is easier to sew.



- In order to sew with a balanced tension, it may be necessary to adjust the upper thread tension. Test with a sample piece of quilting fabric.

- 1 Press  to set the machine to free-motion sewing mode.

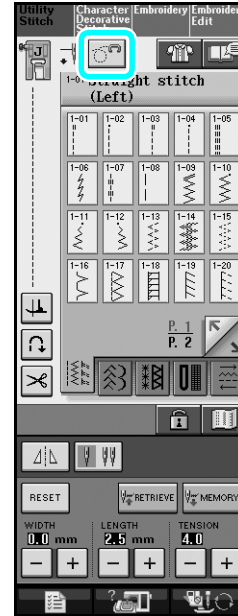

→ The key appears as , and the quilting foot is raised to the necessary height for free-motion sewing.

- 2 Select .
- 3 Remove the presser foot.
- 4 Remove the presser foot holder and the screw.
- 5 Position the free-motion echo quilting foot “E” on the left side of the presser bar with the holes in the quilting foot and presser bar aligned.

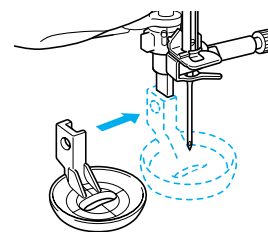

- 6 Tighten the screw.

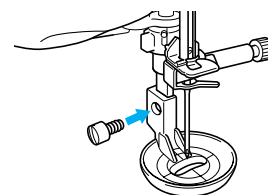

- 7** Using the measurement on the quilting foot as a guide, sew around the motif.

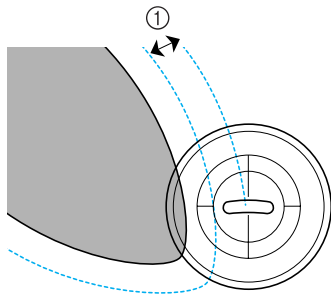
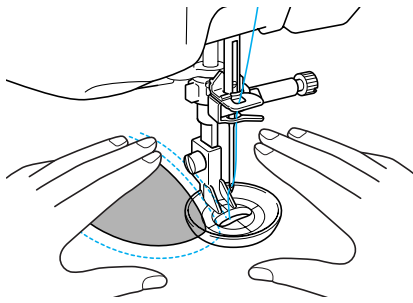

① 6.4 mm (approx. 1/4 inch)

Finished project

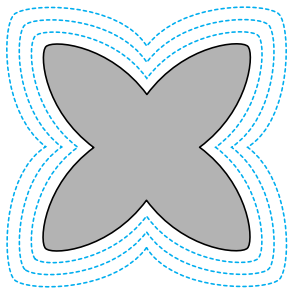

- 8** Press  to cancel the free-motion sewing mode.

## Returning to the Beginning of the Pattern

When sewing character/decorative stitches, you can return to the beginning of the pattern after trial sewing or when the stitching is sewn incorrectly.

- 1** Press the “Start/Stop” button to stop the machine, and then press .

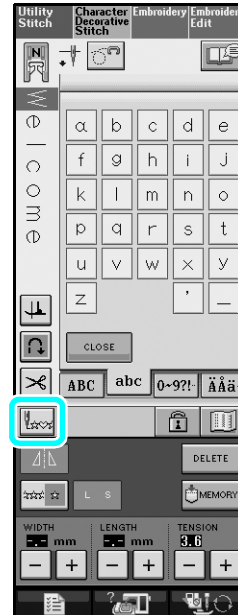

→ Sewing returns to the beginning of the selected pattern (“W”) from the point where sewing was stopped.



### Memo

If this key is pressed when sewing is stopped, patterns can be added at the end of a combined stitch pattern. (In this example, “!” is added.)

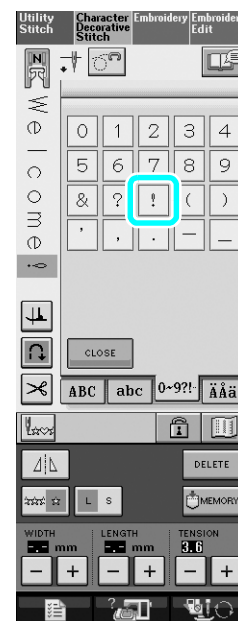

- 2** Press the “Start/Stop” button to continue sewing.

## Measurements on the Bobbin Cover

The measurements on the bobbin cover are references for patterns with a middle (center) needle position. The measurements on the needle plate and the needle plate cover are references for stitches with a left needle position.

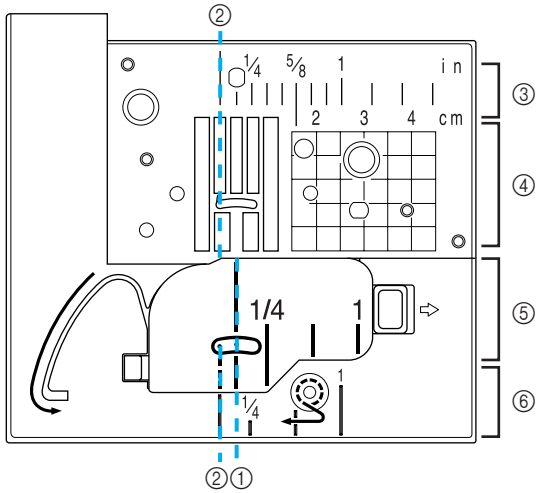

- ① For stitches with a middle (center) needle position
- ② For stitches with a left needle position
- ③ Left needle position on the needle plate <inch>
- ④ Left needle position on the needle plate <cm>
- ⑤ Middle (center) needle position on the bobbin cover <inch>
- ⑥ Left needle position on the needle plate cover <inch>



