



Thank you for choosing Brother, your support is important to us and we value your business. Your Brother product is engineered and manufactured to the highest standards to deliver reliable performance, day-in and day-out.

Please read the Product Safety Guide first before you set up your machine. Then, please read this Quick Setup Guide for the correct setup and installation.





Manuals in Spanish for this model are available on the enclosed CD-ROM.

Manuales en Español para este modelo están disponibles en el CD-ROM incluido.

 WARNING	WARNING indicates a potentially hazardous situation which, if not avoided, could result in death or serious injuries.
 CAUTION	CAUTION indicates a potentially hazardous situation which, if not avoided, may result in minor or moderate injuries.
IMPORTANT	IMPORTANT indicates a potentially hazardous situation which, if not avoided, may result in damage to property or loss of product functionality.
NOTE	Notes tell you how to respond to a situation that may arise or give tips about how the operation works with other features.

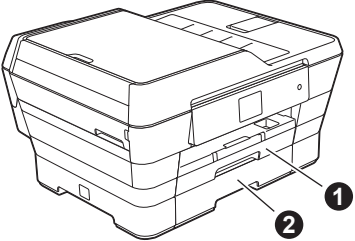
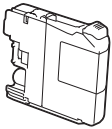
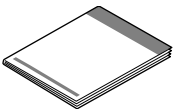
1 Unpack the machine and check the components

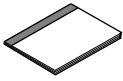
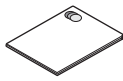
- Most of the illustrations in this Quick Setup Guide show the MFC-J6720DW.
- The components included in the box may differ depending on your country.

 <p>1 Upper tray 2 Lower tray</p>	 <p>Black Yellow Cyan Magenta</p> <p>Starter Ink Cartridges</p>	 <p>Quick Setup Guide</p>
		 <p>CD-ROM*</p>
 <p>Basic User's Guide</p>	 <p>Product Safety Guide</p>	 <p>Telephone Line Cord</p>

* If your computer does not have a CD-ROM drive, the supplied CD-ROM does not contain drivers for your operating system, or you want to download manuals and utilities, visit your model page at <http://solutions.brother.com/>.

WARNING

Plastic bags are used in the packing of your machine. Plastic bags are not toys. To avoid the danger of suffocation, keep these bags away from babies and children and dispose of them correctly.

CAUTION

(For MFC-J6720DW)

To prevent possible injuries, at least two people should lift the product. One person should hold the front of the product, and one person should hold the back. Be careful not to trap your fingers when you put the product down.

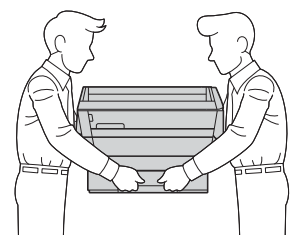

- a** Remove the protective tape and film covering the machine, and also from the Touchscreen.
- b** Make sure you have all the components.

NOTE

- Save all packing materials and the box in case for any reason you must ship your machine.
- You need to purchase the correct interface cable for the interface you want to use (for USB or network connection).

USB cable

We recommend using a USB 2.0 cable (Type A/B) that is no more than 16 feet (five meters) long.

Network cable

Use a straight-through Category5 (or greater) twisted-pair cable for 10BASE-T or 100BASE-TX Fast Ethernet Network.

2 Connect the power cord and telephone line

NOTE

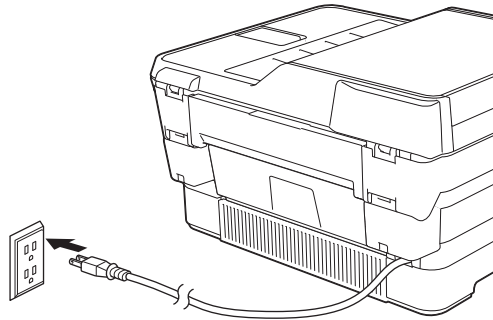

DO NOT connect the USB cable yet (if you are using a USB cable).

- a** Connect the power cord.



NOTE

- If you do not plan to use the fax feature on this machine, go to step **3** on page 4.
- To prolong the life of the print head, provide the best ink cartridge economy and maintain print quality, we do not recommend unplugging the machine frequently and/or leaving the machine unplugged for extended periods of time. Each time you plug the machine in, it automatically cleans the print heads, which uses some of your ink.

We recommend using  to power down the machine. Using  allows minimal power to the machine, resulting in periodic, but less frequent, cleaning of the print heads.

- b** Lift the scanner cover until it locks securely into the open position.

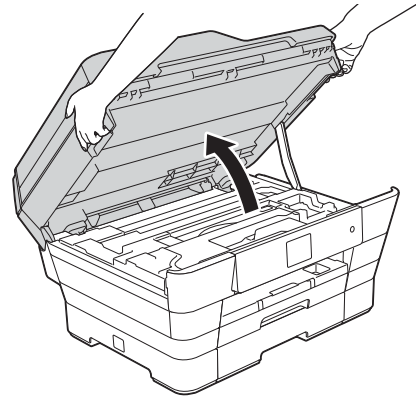

- C** Connect the telephone line cord.
Connect one end of the telephone line cord to the jack marked **LINE** on the machine. Carefully guide the telephone line cord into the cable channel and out the back of the machine. Connect the other end to a modular wall jack.

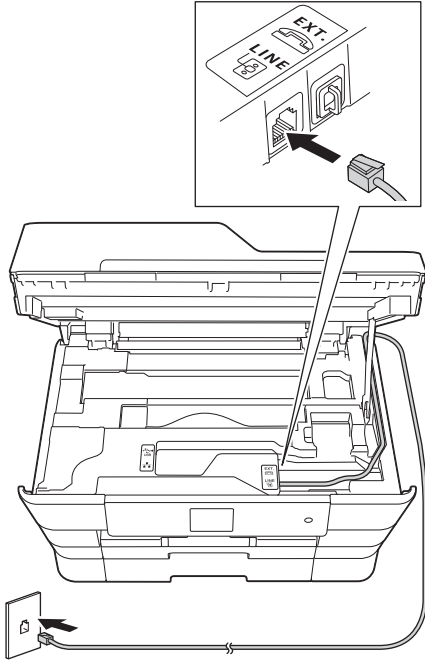

IMPORTANT

The telephone line cord **MUST** be connected to the jack marked **LINE** on the machine.

- d** Gently close the scanner cover using the finger holds on each side.

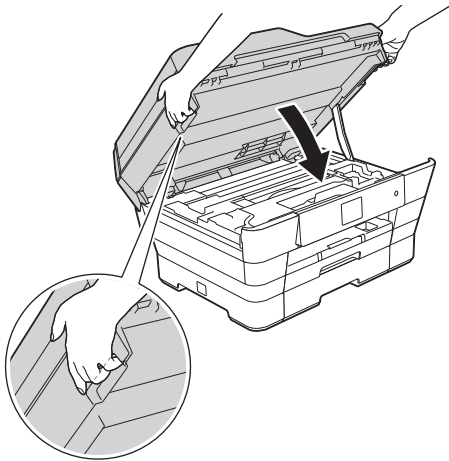

CAUTION

Be careful not to pinch your fingers when you close the scanner cover.
Always use the finger holds provided on each side of the scanner cover when opening and closing it.

NOTE

If you are sharing one telephone line with an external telephone, connect it as shown below.

Before you connect the external telephone, remove the white protective cap ③ from the **EXT.** jack on the machine.

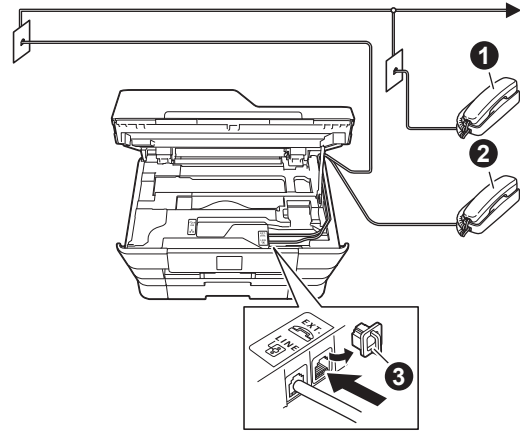

- ① Extension telephone
- ② External telephone
- ③ Protective cap

NOTE

If you are sharing one telephone line with an external telephone answering machine, connect it as shown below.

Before you connect the external telephone answering machine, remove the white protective cap ① from the **EXT.** jack on the machine.

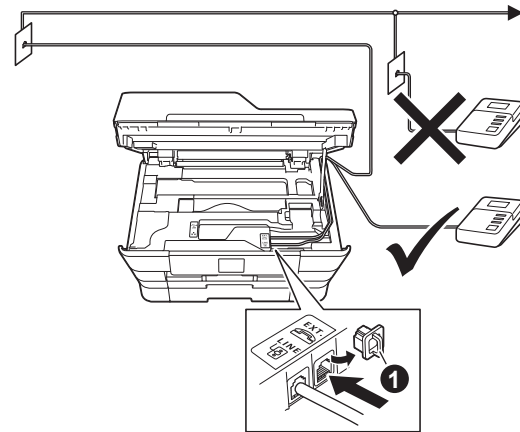

- ① Protective cap

Set the receive mode to **External TAD** if you have an external answering machine. See *Choose the correct Receive Mode* on page 12. For additional details, see *Connecting an external TAD (telephone answering device)* in chapter 6 of the *Basic User's Guide*.

3

Install the ink cartridges

⚠ CAUTION

If ink gets in your eyes, wash it out with water at once and call a doctor if you are concerned.

NOTE

Make sure you install the Starter Ink Cartridges included with your machine first.

- a** Make sure that the power is turned on. The Touchscreen will show No Ink Cartridge.

NOTE

You can adjust the angle of the control panel by lifting it. To lower this control panel, push the release button that is located behind the control panel, as shown in the illustration.

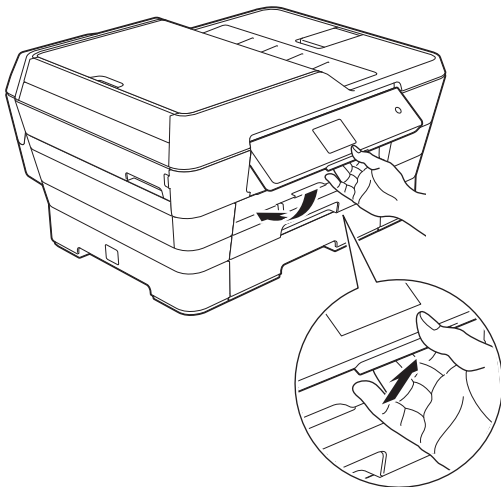

- b** Open the ink cartridge cover ❶.

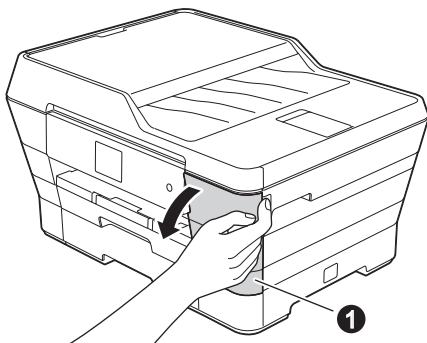

- c** Remove the orange protective part ❶.

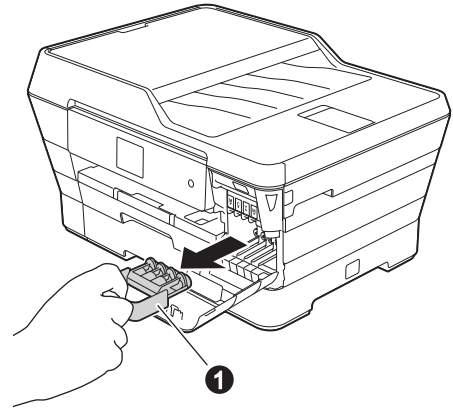

NOTE

Do not throw away the orange protective part. You will need it if you transport the machine.

- d** Lift the scanner cover into the open position.

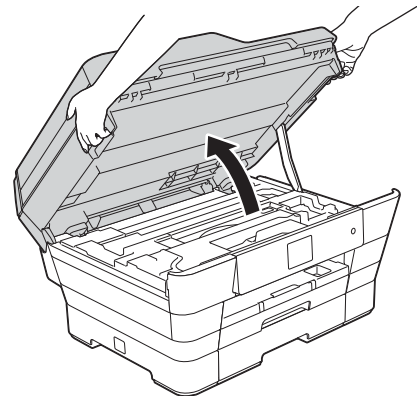

- e** Store the orange protective part in the holder inside the machine as shown. Make sure that the two projections on the bottom of the orange protective part fit into the two slots in the holder.

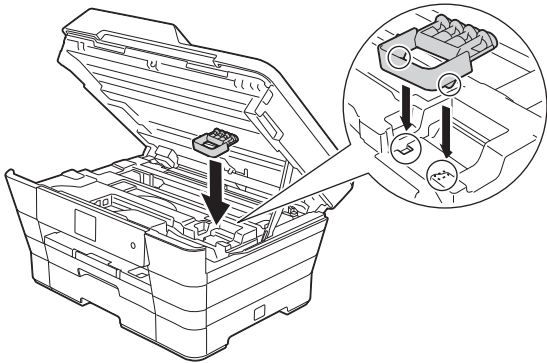

- f** Gently close the scanner cover using the finger holds on each side.

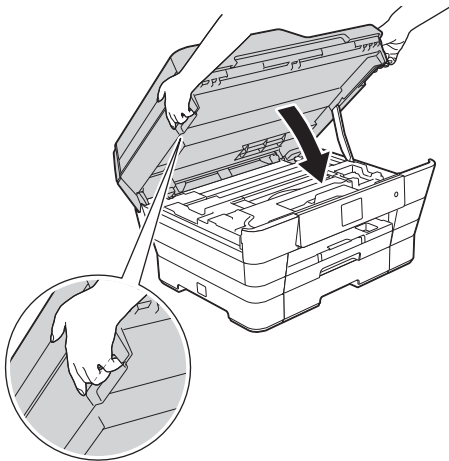

CAUTION

Be careful not to pinch your fingers when you close the scanner cover.
Always use the finger holds provided on each side of the scanner cover when opening and closing it.

- g** Unpack the ink cartridge. Turn the green release lever on the orange protective packing **1** counterclockwise until it clicks to release the vacuum seal. Then remove the orange protective packing **1** as shown.

IMPORTANT

- DO NOT shake the ink cartridges. If ink stains your skin or clothing, wash with soap or detergent at once.
- DO NOT touch the cartridge in the area indicated **2**, as this can cause the machine not to function with the cartridge.

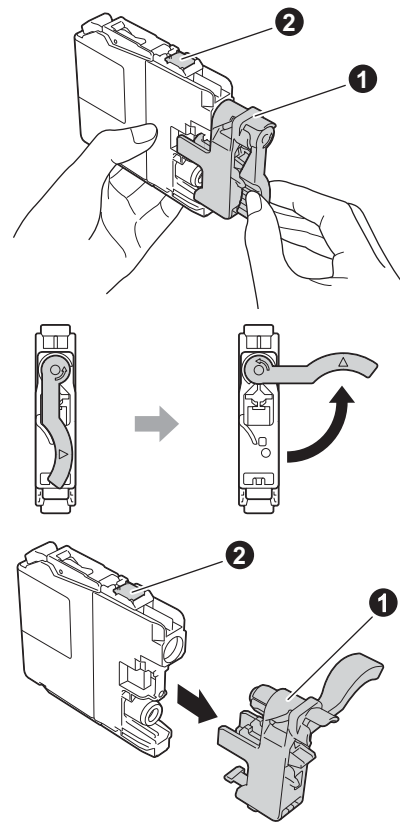

- h** Take care to match the sticker color ① with the cartridge color ② as shown in the diagram below.
Install each ink cartridge in the direction of the arrow on the label.

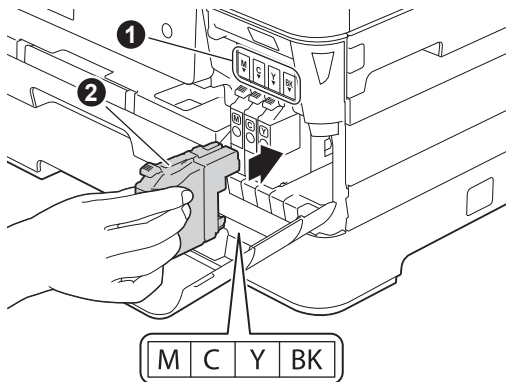

- i** Gently push the back of the ink cartridge marked "PUSH" until it latches. After all the ink cartridges are installed, close the ink cartridge cover.

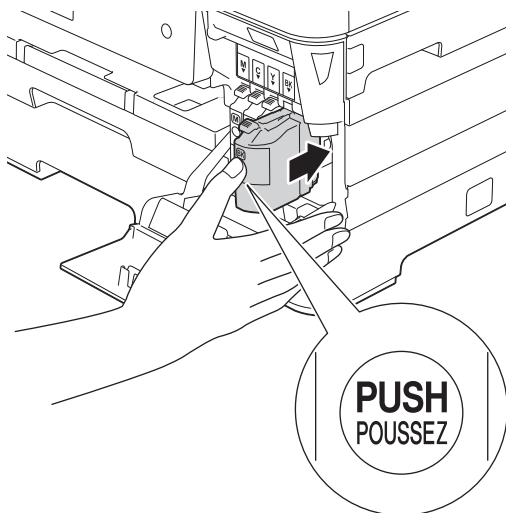

NOTE

The machine will prepare the ink tube system for printing. This process will take approximately four minutes. Do not turn off the machine. We recommend you perform the next step while waiting.

IMPORTANT

- DO NOT take out ink cartridges if you do not need to replace them. If you do so, it may reduce the ink quantity and the machine will not know the quantity of ink left in the cartridge.
- DO NOT repeatedly insert and remove the cartridges. If you do so, ink may seep out of the cartridge.
- Once you open an ink cartridge, install it in the machine and use it up within six months of installation. Use unopened ink cartridges by the expiration date written on the cartridge package.
- DO NOT dismantle or tamper with the ink cartridge, this can cause the ink to leak out of the cartridge.
- Brother strongly recommends that you do not refill the ink cartridges provided with your machine. We also strongly recommend that you continue to use only Genuine Brother Brand replacement ink cartridges. Use or attempted use of potentially incompatible ink and/or cartridges in the Brother machine may cause damage to the machine and/or may result in unsatisfactory print quality. Our warranty coverage does not apply to any problem that is caused by the use of unauthorized third party ink and/or cartridges. To protect your investment and obtain premium performance from the Brother machine, we strongly recommend the use of Genuine Brother Supplies.

4

Load plain Letter/A4 paper

NOTE

Make sure the first printed page is Letter/A4 size.

- a** Pull the paper tray (for MFC-J6720DW, paper tray #1, the upper tray) ❶, completely out of the machine.

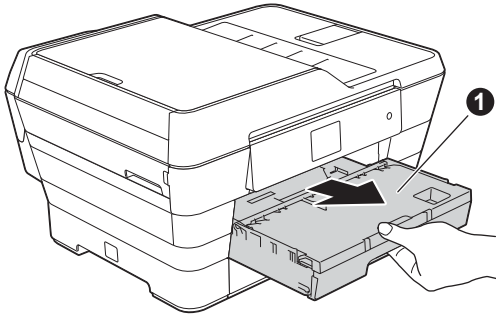

- b** Gently press and slide the paper side guides ❶ to fit the paper size. Make sure that the triangular mark ❷ on the paper side guide ❶ lines up with the mark for the paper size you are using.

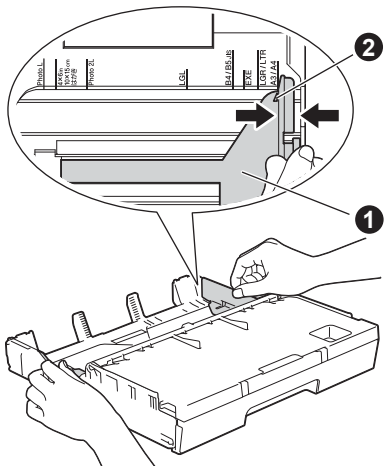

- c** Open the output paper tray cover ❶.

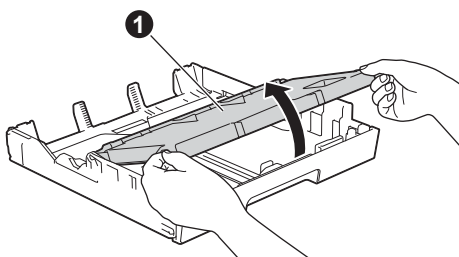

- d** Gently press and slide the paper length guide ❶ to fit the paper size.

Make sure that the triangular marks ❷ on the paper length guide ❶ lines up with the mark for the paper size you are using.

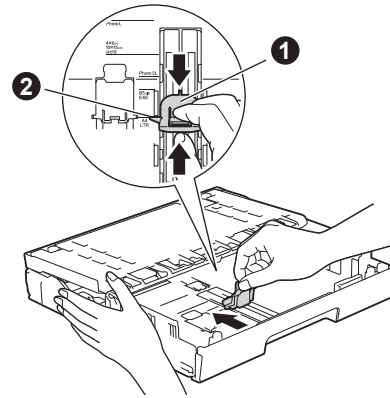

- e** Close the output paper tray cover.

- f** Fan the stack of paper well to avoid paper jams and misfeeds.

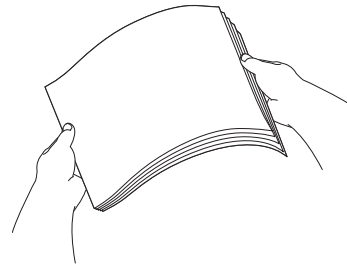

NOTE

Always make sure that the paper is not curled or wrinkled.

- g** Gently put the paper into the paper tray (for MFC-J6720DW, tray #1, the upper tray).

IMPORTANT

Make sure the paper is flat in the tray. If the paper is pushed against the back of the tray, it may cause paper feed problems.

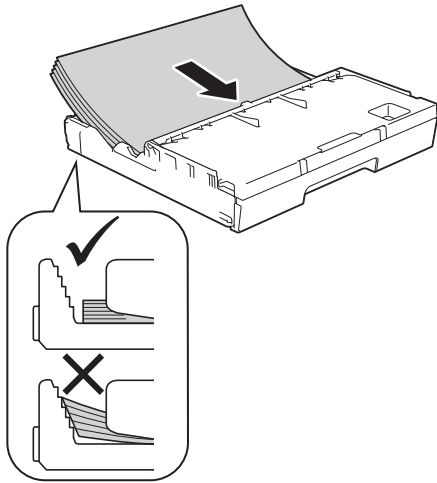

NOTE

- When you use Ledger, Legal, Folio or A3 size paper, press the universal guide release button **1** as you slide out the front of paper tray #1.
- When you load a different paper size in a tray, you will need to change the paper size setting in the machine at the same time. (See *Paper Size and Type* in chapter 2 of the *Basic User's Guide*.)

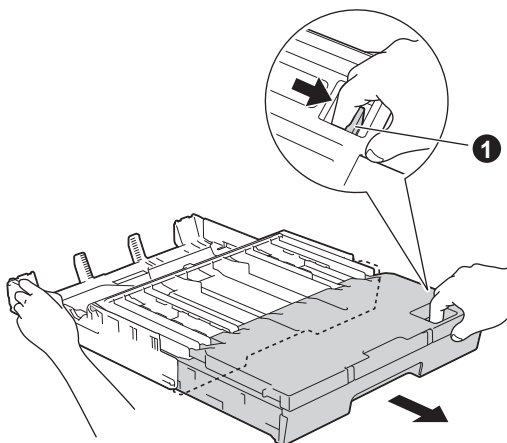

- h** Gently adjust the paper side guides to fit the paper with both hands. Make sure that the paper side guides touch the sides of the paper.

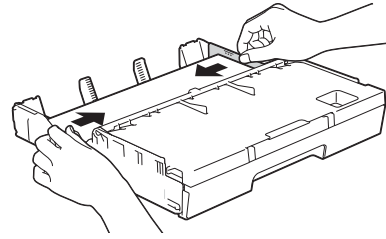

- i** Check that the paper is flat in the tray and below the maximum paper mark **1**.

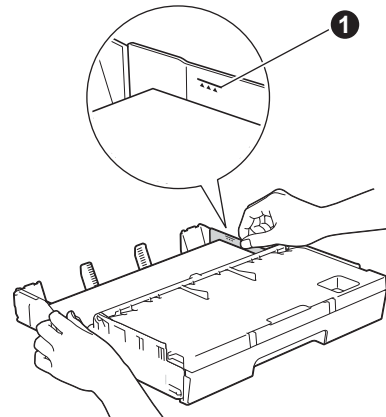

- j** *Slowly* push the paper tray completely into the machine.

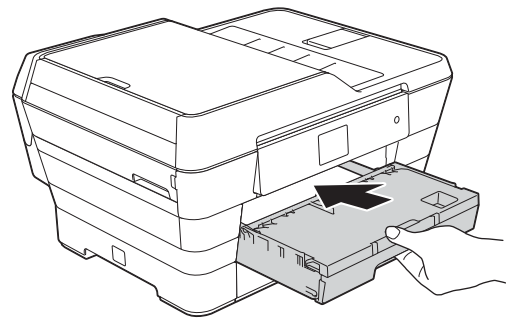

- k** While holding the paper tray in place, pull out the paper support ① until it clicks, and then unfold the paper support flap ②.

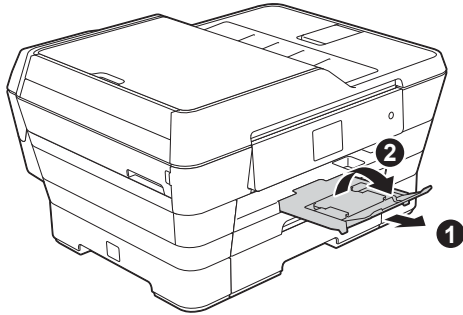

NOTE

- For printing and copying on special print media, open the manual feed slot ① on the back of the machine. Feed only one sheet at a time. For more information, see *Loading paper in the manual feed slot* in chapter 2 of the *Basic User's Guide*.

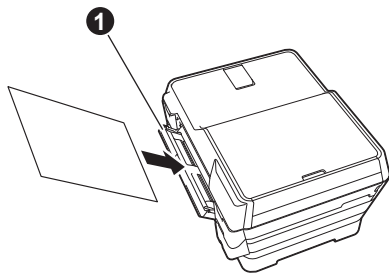

- (MFC-J6720DW)
For information about tray #2 (the lower tray), see *Loading paper in paper tray #2* in chapter 2 of the *Basic User's Guide*.

5 Check the print quality

NOTE

If your machine has two paper trays, make sure there is paper in tray #1, the upper tray, when checking the print quality.

- a** When the preparation process has finished, the Touchscreen shows *Load paper* and press [OK].
Press OK.
- b** Check the quality of the four color blocks on the sheet (black/yellow/cyan/magenta).
- c** If all lines are clear and visible, press *Yes* to finish the quality check and go to the next step.

OK

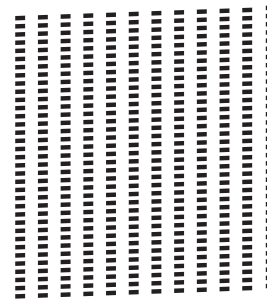

If lines are missing, press *No* and follow the steps on the Touchscreen.

Poor

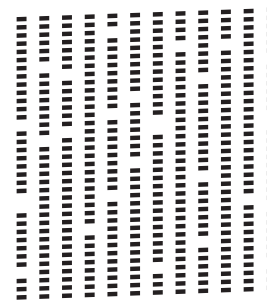

6 Set the date and time

The Touchscreen displays the date and time. You can also add the current date and time to each fax you send by setting your Station ID (see step **10**).

- a** Enter the last two digits of the year on the Touchscreen, and then press **OK**.

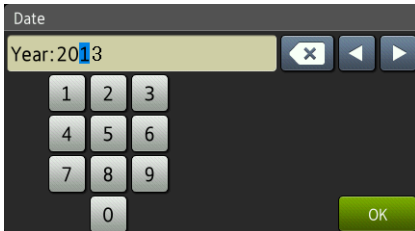

(e.g. Enter 1 3 for 2013.)

- b** Enter the two digits for the month on the Touchscreen, and then press **OK**.
- c** Enter the two digits for the day on the Touchscreen, and then press **OK**.
- d** Enter the time on the Touchscreen in 12-hour format.
Press **AM PM** to cycle **AM** and **PM**.
- e** Press **OK**.

NOTE

You can change date, time, or clock type (12h or 24h) at any time.

For more information, see *Setting the date and time* in the *Basic User's Guide*.

7 Set the paper settings

For your machine to produce the best print quality and to feed the correct paper size, the paper type and size must be set to match the paper in the tray.

For more information on the types and sizes of paper supported, see *Paper Size and Type* in *chapter 2* of the *Basic User's Guide*.

NOTE



(For MFC-J6720DW)

You can change the default tray that the machine will use for printing copies or received faxes (see *Tray use in Copy mode* or *Tray use in Fax mode* in *chapter 2* of the *Basic User's Guide*).

- a** (For MFC-J6720DW)
When **Tray Setting** appears on the Touchscreen, press **Tray Setting** to set the paper size and paper type.
(For MFC-J6520DW)
Press **Paper Setting**. Go to step **c**.
- b** Press **Tray #1** to set paper size and paper type for tray #1, or press **Tray #2** to set paper size for tray #2.
- c** Press the size and type of paper you are using.
- d** Press **OK**.

8

Choose your language (if needed)

- a** Press  (Settings).
- b** Press All Settings.
- c** Press ▲ or ▼ to display Initial Setup.
Press Initial Setup.
- d** Press ▲ or ▼ to display Local Language.
Press Local Language.
- e** Press your language.
- f** Press .

9

Choose the correct Receive Mode

The correct Receive Mode is determined by the external devices and telephone subscriber services (Voice Mail, Distinctive Ring, etc.) you have (or will be using) on the same line as the Brother machine.

For details, see *Using Receive Modes* in *chapter 5* of the *Basic User's Guide*.

If you are not using this machine for faxing, go to the next step.

Will you be using a Distinctive Ring number for receiving faxes?

Brother uses the term “Distinctive Ring” but telephone companies may have other names for this service such as Custom Ringing, RingMaster, Personalized Ring, Teen Ring, Ident-A-Call, and Smart Ring. See *Distinctive Ring* in *chapter 6* of the *Basic User's Guide* for instructions on setting up your machine using this feature.

Will you be using Voice Mail on the same telephone line as your Brother machine?

If you have Voice Mail on the same telephone line as your Brother machine, there is a strong possibility that Voice Mail and the Brother machine will conflict with each other when receiving incoming calls. See *Voice Mail* in *chapter 6* of the *Basic User's Guide* for instructions on setting up your machine using this service.

Will you be using a Telephone Answering Device on the same telephone line as your Brother machine?

Your external telephone answering device (TAD) will automatically answer every call. Voice messages are stored on the external TAD and fax messages are printed. Choose `External TAD` as your Receive Mode. See the instructions below. For additional details, see *Connecting an external TAD (telephone answering device)* in *chapter 6* of the *Basic User's Guide*.

Will you be using your Brother machine on a dedicated fax line?

Your machine automatically answers every call as a fax. Choose `Fax Only` as your Receive Mode. See the instructions below.

Will you be using your Brother machine on the same line as your telephone?



Do you want to receive voice calls and faxes automatically?

The `Fax/Tel` receive mode is used when sharing the Brother machine and your telephone on the same line. Choose `Fax/Tel` as your Receive Mode. See the instructions below. For additional information see *Fax/Tel* in *chapter 5* of the *Basic User's Guide* for instructions on setting up and using this receive mode.

Important Note: You cannot receive voice messages on either Voice Mail or an answering machine when choosing the `Fax/Tel` mode.

Do you expect to receive very few faxes?

Choose `Manual` as your Receive Mode. You control the phone line and must answer every call yourself. See the instructions below.

- a** Press  (Settings).
- b** Press `All Settings`.
- c** Press `Fax`.
- d** Press `Setup Receive`.
- e** Press `Receive Mode`.
- f** Press your preferred receive mode.
- g** Press .

NOTE



If the Receive Mode option is not displayed, make sure the Distinctive Ring feature is set to Off. (See *Turning off Distinctive Ring* in *chapter 6* of the *Basic User's Guide*.)

10 Set your Station ID

Set your machine's Station ID so that the date and time appear on each fax you send.
If you are not using this machine for faxing, go to the next step.

- a** Press  (Settings).
- b** Press All Settings.
- c** Press ▲ or ▼ to display Initial Setup.
Press Initial Setup.
- d** Press Station ID.
- e** Press Fax.
- f** Enter your fax number (up to 20 digits) on the Touchscreen, and then press OK.
- g** Press Name.
- h** Enter your name (up to 20 characters) using the Touchscreen, and then press OK.

NOTE

- Press  to cycle between lower case and upper case.
- Press  to cycle between letters, numbers and special characters. (The characters available may differ depending on your country.)
- If you entered a number or a character incorrectly and want to change it, press ◀ or ▶ to move the cursor to the incorrect one. Press  and then enter the correct character.
- To enter a space, press Space. Or, you can press ▶ to move the cursor.

- i** Press .

NOTE

(USA only)



The Telephone Consumer Protection Act of 1991 makes it unlawful for any person to use a computer or electronic device to send any message via a telephone fax machine unless such messages clearly contain, in a margin at the top or bottom of each transmitted page, or on the first page of the transmission, the date and time it is sent and an identification of the business or other entity or other individual sending the message and the telephone number of the sending machines or such business, other entity or individual.

11 Transmission Verification Report

Your Brother machine is equipped with a Transmission Verification Report that can be used as confirmation that you sent a fax. This report lists the name or fax number of the receiving party, the date, time, and duration of the transmission, the number of pages transmitted, and whether or not the transmission was successful. If you want to use the Fax Transmission Report feature, see *Transmission Verification Report* in chapter 4 of the *Basic User's Guide*.

12 Set Tone or Pulse dialing mode (Canada only)

Your machine comes set for a Tone dialing service. If you have a Pulse dialing (rotary) service, you need to change the dialing mode.



- a** Press  (Settings).
- b** Press All Settings.
- c** Press ▲ or ▼ to display Initial Setup.
Press Initial Setup.
- d** Press Tone/Pulse.
- e** Press Pulse (or Tone).
- f** Press .

13 Set the telephone line compatibility (VoIP)

If you are connecting the machine to a VoIP service (over the Internet), you need to change the compatibility setting.



NOTE

If you are using an analog telephone line, you can skip this step.

- a** Press  (Settings).
- b** Press All Settings.
- c** Press ▲ or ▼ to display Initial Setup.
Press Initial Setup.
- d** Press ▲ or ▼ to display Compatibility.
Press Compatibility.
- e** Press Basic (for VoIP).
- f** Press .



14 Automatic Daylight Saving Time

You can set the machine to change automatically for Daylight Saving Time. It will reset itself forward one hour in the spring and backward one hour in the fall.

- a** Press  (Settings).
- b** Press All Settings.
- c** Press ▲ or ▼ to display Initial Setup.
Press Initial Setup.
- d** Press Date & Time.
- e** Press ▲ or ▼ to display Auto Daylight.
Press Auto Daylight.
- f** Press On (or Off).
- g** Press .

15 Set the Time Zone

You can set the time zone for your location on the machine. For example, the time zone for Eastern Time in the USA and Canada is UTC-05:00. Pacific Time in the USA and Canada is UTC-08:00.

- a** Press  (Settings).
- b** Press All Settings.
- c** Press ▲ or ▼ to display Initial Setup.
Press Initial Setup.
- d** Press Date & Time.
- e** Press ▲ or ▼ to display Time Zone.
Press Time Zone.
- f** Enter your time zone.
Press OK.
- g** Press .

Time Zone	Standard Time
Hawaii-Aleutian Time Zone	UTC - 10:00
Alaska Time Zone	UTC - 09:00
Pacific Time Zone	UTC - 08:00
Mountain Time Zone	UTC - 07:00
Central Time Zone	UTC - 06:00
Eastern Time Zone	UTC - 05:00
Atlantic Time Zone	UTC - 04:00
Chamorro Standard Time Zone	UTC + 10:00

16 Choose your connection type

These installation instructions are for Windows® XP Home, XP Professional, XP Professional x64 Edition, Windows Vista®, Windows® 7, Windows® 8, and Mac OS X v10.6.8, 10.7.x, 10.8.x.

NOTE

If your computer does not have a CD-ROM drive, the supplied CD-ROM does not contain drivers for your operating system, or you want to download manuals and utilities, visit your model page at <http://solutions.brother.com/>. Some software applications included on the CD-ROM may not be available as a download.

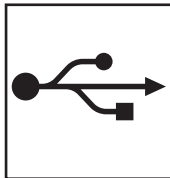
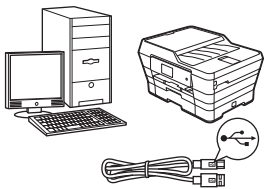

For USB interface cable

Windows®, go to page 16
Macintosh, go to page 19

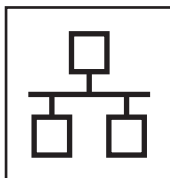
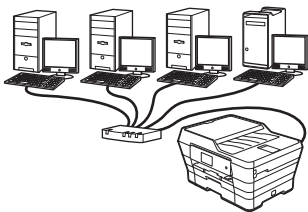

For Wired Network

Windows®, go to page 22
Macintosh, go to page 26

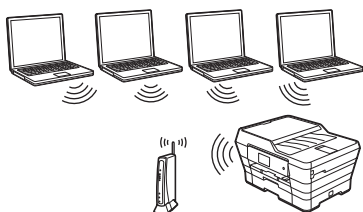

For Wireless Network

Windows®, Macintosh and mobile devices go to page 29

Windows®
USB
Macintosh

Windows®
Wired Network
Macintosh

Wireless Network



For Windows® USB interface users

(Windows® XP Home/XP Professional/Windows Vista®/Windows® 7/Windows® 8)

17 Before you install

Make sure that your computer is ON and you are logged on with Administrator rights.

NOTE

- DO NOT connect the USB cable yet.
- If there are any programs running, close them.
- The screens may differ depending on your operating system.
- The CD-ROM includes Nuance™ PaperPort™ 12SE. This software supports Windows® XP Home (SP3 or greater), XP Professional (SP3 or greater), XP Professional x64 Edition (SP2 or greater), Windows Vista® (SP2 or greater), Windows® 7 and Windows® 8. Update to the latest Windows® Service Pack before installing MFL-Pro Suite.
- If the **Windows Security** screen appears, click the check box and click **Install** to complete the installation correctly.

18 Install MFL-Pro Suite

- a** Put the CD-ROM into your CD-ROM drive. If the model name screen appears, choose your machine. If the language screen appears, choose your language.

NOTE

- If the Brother screen does not appear automatically, go to **Computer (My Computer)**.
(For Windows® 8: click the  (**File Explorer**) icon on the taskbar, and then go to **Computer**.) Double-click the CD-ROM icon, and then double-click **start.exe**.
- If the User Account Control screen appears, click **Allow** or **Yes**.

- b** Click **Install MFL-Pro Suite** and click **Yes** if you accept the license agreements. Follow the on-screen instructions.

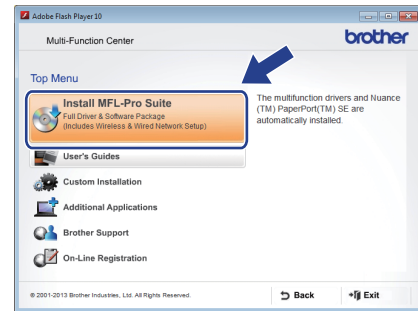

- c** Choose **Local Connection (USB)**, and then click **Next**.

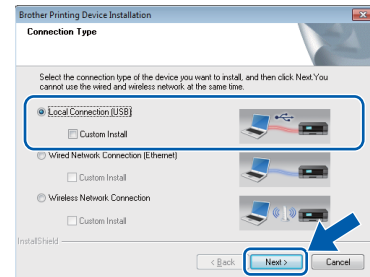

- d** Follow the on-screen instructions until the **Plug in the USB cable** screen appears.





19 Connect the USB cable

a Lift the scanner cover until it locks securely into the open position.

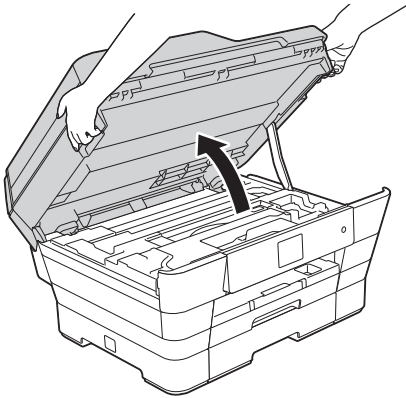

b Connect the USB cable to the USB port marked with a  symbol ❶. You will find the USB port inside the machine, as shown in the callout below.

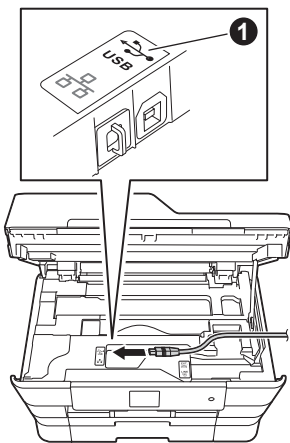

c Carefully guide the USB cable into the cable channel and out the back of the machine. Connect the cable to your computer.

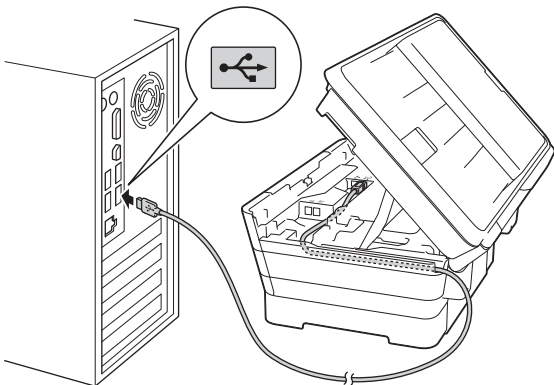

IMPORTANT

Make sure that the cable does not restrict the cover from closing, or an error may occur.

d Gently close the scanner cover using the finger holds on each side.

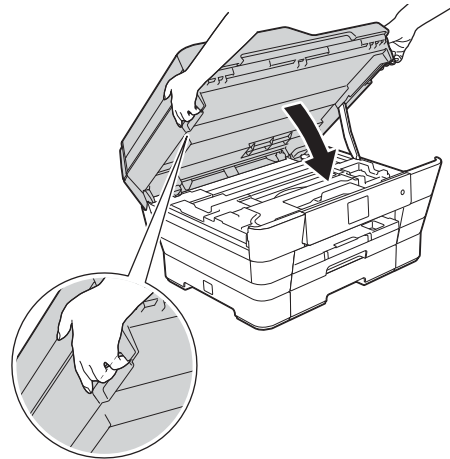

CAUTION

Be careful not to pinch your fingers when you close the scanner cover. Always use the finger holds provided on each side of the scanner cover when opening and closing it.

e The installation will continue automatically. The installation screens appear one after another.

NOTE

DO NOT cancel any of the screens during the installation. It may take a few seconds for all screens to appear.

f If the **Environmental Advice for Imaging Equipment** screen appears, click **Next**.

g When the **On-Line Registration** screen appears, follow the on-screen instructions. Click **Next**.

h If you do not want to set your machine as the default printer, clear the **Set as Default Printer** check box, and then click **Next**.

i When the **Setup is Complete** window appears, confirm the settings, and then click **Next**.



20 Finish and restart

- a** Click **Finish** to restart your computer. After restarting the computer, you must log on with Administrator rights.

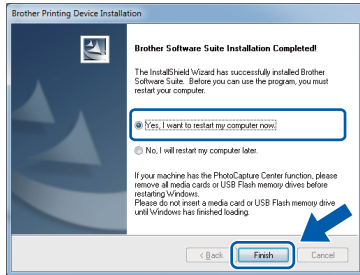

NOTE

- If an error message appears during the software installation, do one of the following:
 - Windows® XP, Windows Vista® and Windows® 7 users: Run the **Installation Diagnostics** located in (**Start**) > **All Programs** > **Brother** > **MFC-XXXX** (where XXXX is your model name).
 - Windows® 8 users: To run the **Installation Diagnostics**, double-click (**Brother Utilities**) on the desktop, and then click the drop-down list and select your model name (if not already selected). Click **Tools** in the left navigation bar.
- Depending on your security settings, a Windows® Security or antivirus software window may appear when using the machine or its software. Please allow or permit the window to continue.

- b** The following screens will appear.

- When the **Software Update Setting** screen appears, choose the software update setting you want and click **OK**.
- When the Brother Product Research and Support Program screen appears, select your preference and follow the on-screen instructions.

NOTE

- Internet access is required for the software update and the Brother Product Research and Support Program.
- When you install MFL-Pro Suite, Brother Help will also be installed automatically. Brother Help allows you to access the Brother Solutions Center when you click in the task tray.

Finish

The installation is now complete.

To install optional applications:

Now go to

Page 43

NOTE

Windows® 8 users: If the Brother manuals included on the CD-ROM are in PDF format, use Adobe® Reader® to open them. If Adobe® Reader® is installed on your computer but you cannot open the files in Adobe® Reader®, change the file association for PDF (see *How to open a PDF file in Adobe® Reader® (Windows® 8)* on page 45).



For Macintosh USB interface users (Mac OS X v10.6.8, 10.7.x, 10.8.x)

17 Before you install

Make sure your machine is connected to the power and your Macintosh is ON. You must be logged on with Administrator rights.

NOTE

For Mac OS X v10.6.0 to 10.6.7 users, upgrade to Mac OS X v10.6.8 - 10.8.x.

18 Connect the USB cable

NOTE

- DO NOT connect the machine to a USB port on a keyboard or a non-powered USB hub.
- Connect the machine directly to your Macintosh.

a Lift the scanner cover until it locks securely into the open position.

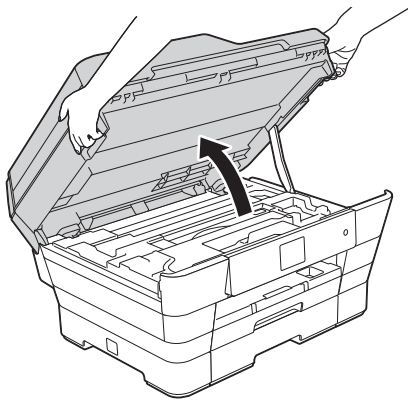

b Connect the USB cable to the USB port marked with a  symbol **1**. You will find the USB port inside the machine, as shown in the callout below.

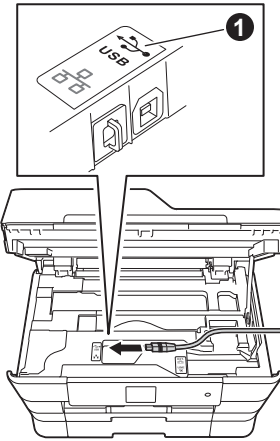

c Carefully guide the USB cable into the cable channel and out the back of the machine. Connect the cable to your Macintosh.

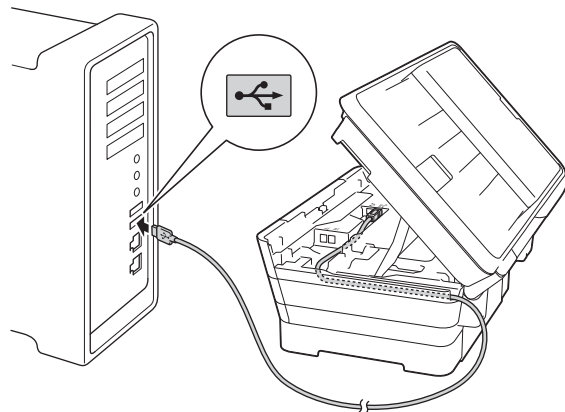

IMPORTANT

Make sure that the cable does not restrict the cover from closing, or an error may occur.



- d** Gently close the scanner cover using the finger holds on each side.

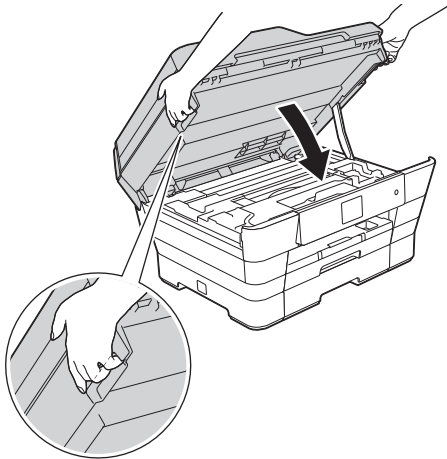

CAUTION

Be careful not to pinch your fingers when you close the scanner cover.
Always use the finger holds provided on each side of the scanner cover when opening and closing it.

19 Install MFL-Pro Suite

- a** Put the CD-ROM into your CD-ROM drive.
- b** Double-click the **Start Here OSX** icon to install. If the model name screen appears, choose your machine.



- c** Choose **Local Connection (USB)**, and then click **Next**. Follow the on-screen instructions.

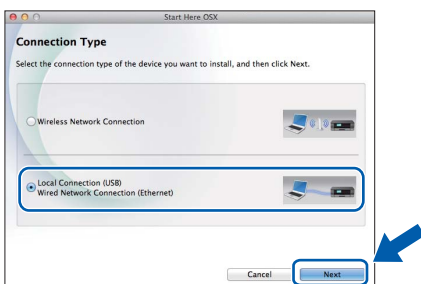

- d** After the installation, the Brother software will search for the Brother device. This will take a few moments to complete.

- e** Choose your machine from the list, and then click **Next**.

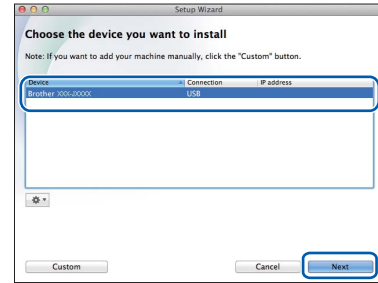

- f** When the **Add Printer** screen appears, click **Add Printer**.

- g** Choose your machine from the list. Click **Add** and then click **Next**.

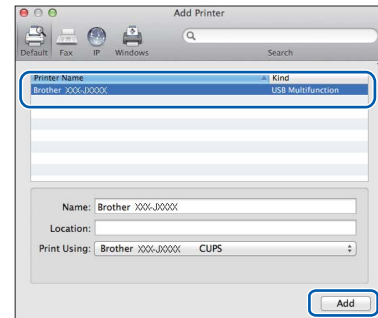

When the support screen appears, follow the on-screen instructions if you want to download **Presto! PageManager**. You can also download **Presto! PageManager** later from the **Brother Support** screen. Click **Next**.

- h** When this screen appears, click **Close**.

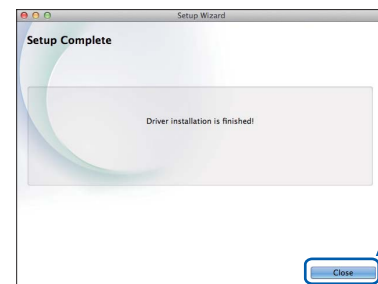

OK! The installation of MFL-Pro Suite is now complete. Go to step 20.



20 Download and install Presto! PageManager

When Presto! PageManager is installed, OCR capability is added to Brother ControlCenter2. You can easily scan, share and organize photos and documents using Presto! PageManager.

- a On the **Brother Support** screen, click the **Presto! PageManager** icon to go to the Presto! PageManager download site, and follow the on-screen instructions.

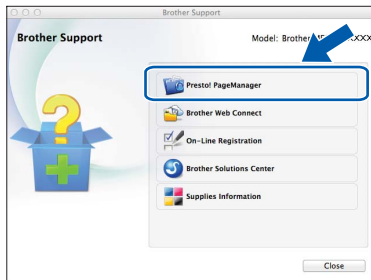

Finish

The installation is now complete.

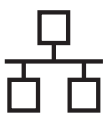

For Windows® wired network interface users

(Windows® XP Home/XP Professional/Windows Vista®/Windows® 7/Windows® 8)

17 Before you install

Make sure that your computer is ON and you are logged on with Administrator rights.

NOTE

- If there are any programs running, close them.
- The screens may differ depending on your operating system.
- The CD-ROM includes Nuance™ PaperPort™ 12SE. This software supports Windows® XP Home (SP3 or greater), XP Professional (SP3 or greater), XP Professional x64 Edition (SP2 or greater), Windows Vista® (SP2 or greater), Windows® 7 and Windows® 8. Update to the latest Windows® Service Pack before installing MFL-Pro Suite.
- If you have previously set up your machine for a wireless network and then want to set it up on a wired network, make sure the machine's Network I/F is set to Wired LAN. The wireless network interface will become inactive with this setting.

On your machine, press  (Settings).

Press All Settings.

Press ▲ or ▼ to display Network.

Press Network.

Press ▲ or ▼ to display Network I/F.

Press Network I/F.

Press Wired LAN.

Press .

18 Connect the network cable

- a** Lift the scanner cover until it locks securely into the open position.

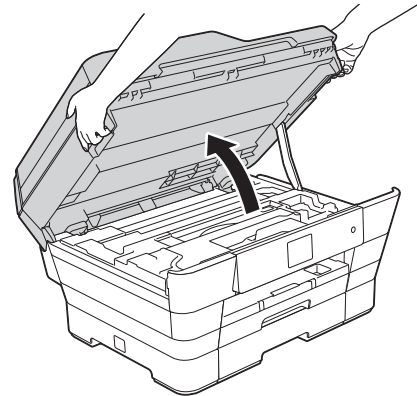

- b** Connect the network cable to the Ethernet port marked with a  symbol ①. You will find the Ethernet port inside the machine, as shown in the callout below. Remove the orange protective cap ② before connecting the cable.

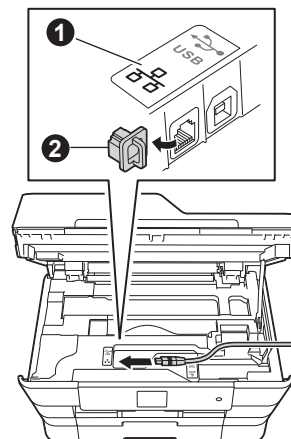

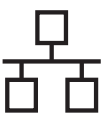

- c** Carefully guide the network cable into the cable channel and out the back of the machine. Connect the cable to your network.

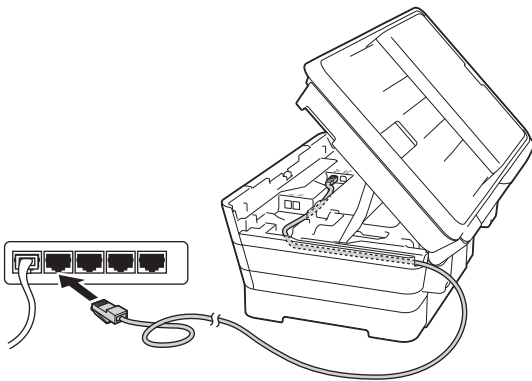

IMPORTANT

Make sure that the cable does not restrict the cover from closing, or an error may occur.

NOTE

If both the USB and the network cables are being used, guide both cables through the cable channel with one on top of the other.

- d** Gently close the scanner cover using the finger holds on each side.

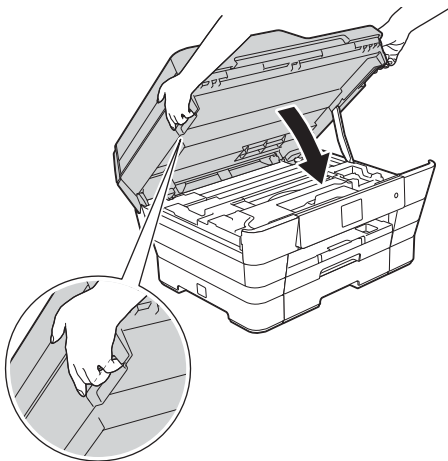

CAUTION

Be careful not to pinch your fingers when you close the scanner cover. Always use the finger holds provided on each side of the scanner cover when opening and closing it.

19 Install MFL-Pro Suite

- a** Put the CD-ROM into your CD-ROM drive. If the model name screen appears, choose your machine. If the language screen appears, choose your language.

NOTE

- If the Brother screen does not appear automatically, go to **Computer (My Computer)**.
(For Windows® 8: click the (File Explorer) icon on the taskbar, and then go to **Computer**.) Double-click the CD-ROM icon, and then double-click **start.exe**.
- If the User Account Control screen appears, click **Allow** or **Yes**.

- b** Click **Install MFL-Pro Suite** and click **Yes** if you accept the license agreements. Follow the on-screen instructions.

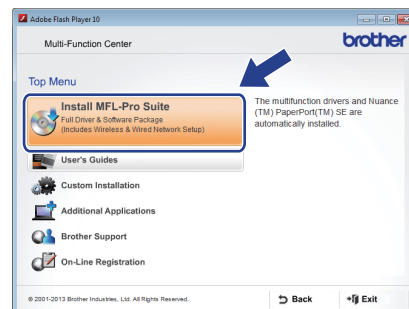

- c** Choose **Wired Network Connection (Ethernet)**, and then click **Next**.

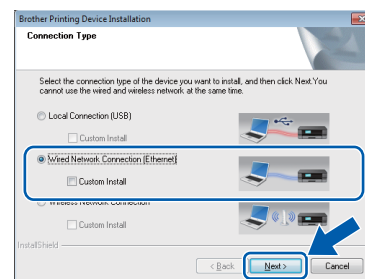

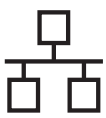

- d** When the **Firewall/AntiVirus detected** screen appears, choose **Change the Firewall port settings to enable network connection and continue with the installation. (Recommended)**, and then click **Next**.

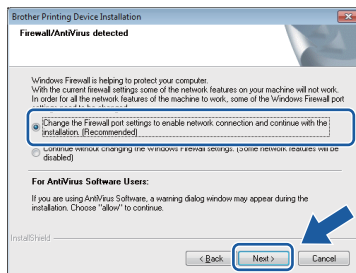

If you are not using the Windows® Firewall, see the instructions provided with your firewall software for information on how to add the following network ports.

- For network scanning, add UDP port 54925.
- For network PC-Fax receiving, add UDP port 54926.
- If you still have trouble with your network connection, add UDP ports 137 and 161.

NOTE

- If there is more than one machine connected to the network, choose your machine from the list, and then click **Next**. This window will not appear if there is only one machine connected to the network, the machine will be chosen automatically.

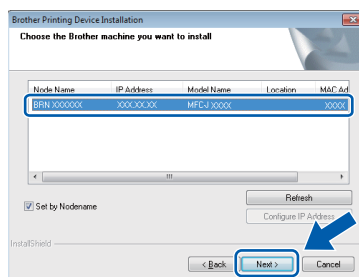

- If your machine is not found over the network, confirm your settings by following the on-screen instructions.

- e** The installation of the Brother drivers will automatically start. The installation screens appear one after another.

NOTE

- DO NOT cancel any of the screens during the installation. It may take a few seconds for all screens to appear.
- If the **Windows Security** screen appears, click the check box and click **Install** to complete the installation correctly.

- f** If the **Environmental Advice for Imaging Equipment** screen appears, click **Next**.

- g** When the **On-Line Registration** screen appears, follow the on-screen instructions. Click **Next**.

- h** If you do not want to set your machine as the default printer, clear the **Set as Default Printer** check box, and then click **Next**.

- i** When the **Setup is Complete** window appears, confirm the settings, and then click **Next**.

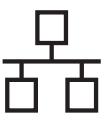

20 Finish and restart

- a Click **Finish** to restart your computer. After restarting the computer, you must log on with Administrator rights.

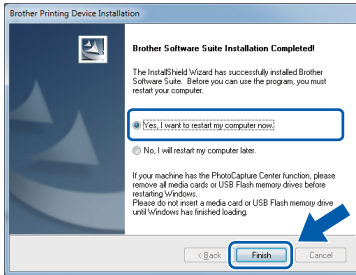

NOTE

- If an error message appears during the software installation, do one of the following:
 - Windows® XP, Windows Vista® and Windows® 7 users: Run the **Installation Diagnostics** located in (Start) > **All Programs > Brother > MFC-XXXX LAN** (where XXXX is your model name).
 - Windows® 8 users: To run the **Installation Diagnostics**, double-click (Brother Utilities) on the desktop, and then click the drop-down list and select your model name (if not already selected). Click **Tools** in the left navigation bar.
- Depending on your security settings, a Windows® Security or antivirus software window may appear when using the machine or its software. Please allow or permit the window to continue.

- b The following screens will appear.
 - When the **Software Update Setting** screen appears, choose the software update setting you want and click **OK**.
 - When the Brother Product Research and Support Program screen appears, select your preference and follow the on-screen instructions.

NOTE

- Internet access is required for the software update and the Brother Product Research and Support Program.
- When you install MFL-Pro Suite, Brother Help will also be installed automatically. Brother Help allows you to access the Brother Solutions Center when you click in the task tray.

21 Install MFL-Pro Suite on additional computers (if needed)

If you want to use your machine with multiple computers on the network, install MFL-Pro Suite on each computer. Go to step **19** on page 23. Also see step **17** on page 22 before you install.

NOTE

Network license (Windows®)

This product includes a PC license for up to two users. This license supports the installation of the MFL-Pro Suite including Nuance™ PaperPort™ 12SE on up to two PCs on the network. If you want to use more than two PCs with Nuance™ PaperPort™ 12SE installed, please purchase the Brother NL-5 pack which is a multiple PC license agreement pack for up to five additional users. To purchase the NL-5 pack, contact your authorized Brother dealer or contact Brother customer service.

Finish

The installation is now complete.

To install optional applications:

Now go to

Page 43

NOTE

- To use a mobile device with your Brother machine, see the User's Guide by visiting the Brother Solutions Center at <http://solutions.brother.com/> and clicking **Manuals** on your model's page.
- Windows® 8 users: If the Brother manuals included on the CD-ROM are in PDF format, use Adobe® Reader® to open them. If Adobe® Reader® is installed on your computer but you cannot open the files in Adobe® Reader®, change the file association for PDF (see *How to open a PDF file in Adobe® Reader®* (Windows® 8) on page 45).

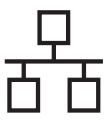



For Macintosh wired network interface users (Mac OS X v10.6.8, 10.7.x, 10.8.x)

17 Before you install

Make sure your machine is connected to the power and your Macintosh is ON. You must be logged on with Administrator rights.

NOTE

- For Mac OS X v10.6.0 to 10.6.7 users, upgrade to Mac OS X v10.6.8 - 10.8.x.
- If you have previously set up your machine for a wireless network and then want to set it up on a wired network, make sure the machine's Network I/F is set to Wired LAN. The wireless network interface will become inactive with this setting.

On your machine, press  (Settings).
Press All Settings.
Press ▲ or ▼ to display Network.
Press Network.
Press ▲ or ▼ to display Network I/F.
Press Network I/F.
Press Wired LAN.
Press .

18 Connect the network cable

- a** Lift the scanner cover until it locks securely into the open position.

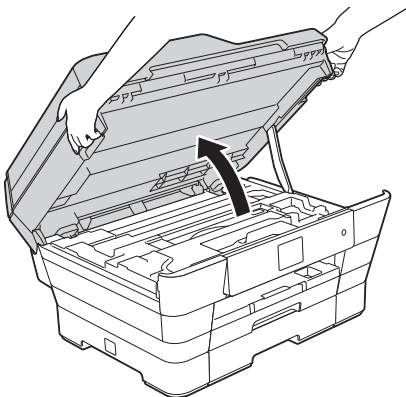

- b** Connect the network cable to the Ethernet port marked with a  symbol ①. You will find the Ethernet port inside the machine, as shown in the callout below. Remove the orange protective cap ② before connecting the cable.

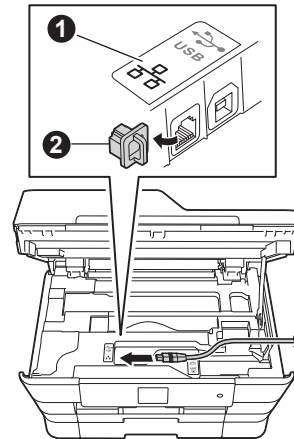

- c** Carefully guide the network cable into the cable channel and out the back of the machine. Connect the cable to your network.

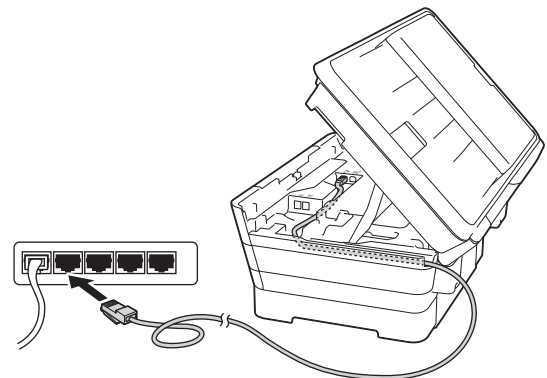

IMPORTANT

Make sure that the cable does not restrict the cover from closing, or an error may occur.

NOTE

If both the USB and the network cables are being used, guide both cables through the cable channel with one on top of the other.

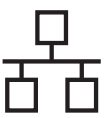

- d** Gently close the scanner cover using the finger holds on each side.

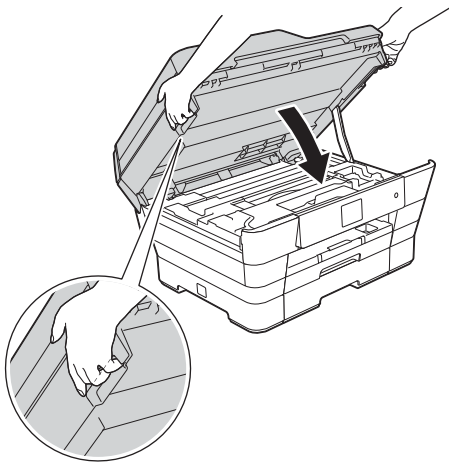

CAUTION

Be careful not to pinch your fingers when you close the scanner cover. Always use the finger holds provided on each side of the scanner cover when opening and closing it.

19 Install MFL-Pro Suite

- a** Put the CD-ROM into your CD-ROM drive.
- b** Double-click the **Start Here OSX** icon to install. If the model name screen appears, choose your machine.



- c** Choose **Wired Network Connection (Ethernet)**, and then click **Next**. Follow the on-screen instructions.

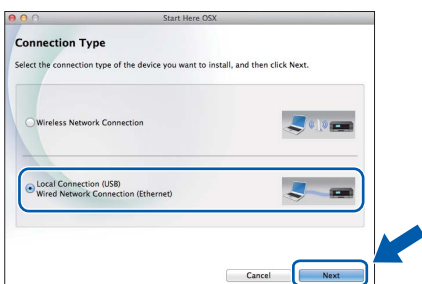

- d** After the installation, the Brother software will search for the Brother device. This will take a few moments to complete.
- e** Choose your machine from the list, and then click **Next**.

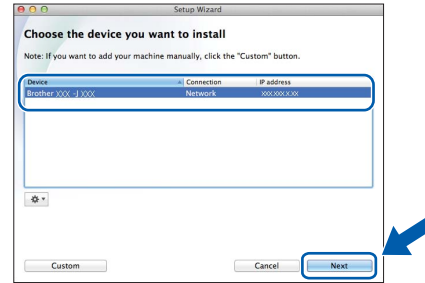

NOTE

- If your machine is not found over the network, confirm your network settings.
- You can find your machine's MAC Address (Ethernet Address) and IP Address by printing out the Network Configuration Report. See *Print the Network Configuration Report* in the *Software and Network User's Guide*.
- If the **Setup Network "Scan to"** name screen appears, follow the instructions below.

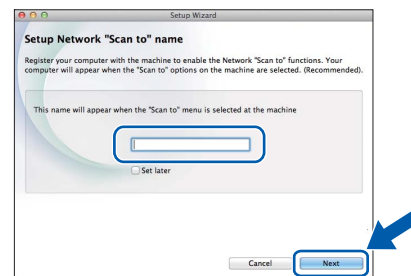

- 1) Enter a name for your Macintosh (up to 15 characters long).
- 2) Click **Next**. Go to **f**.

The name you enter will appear on the machine's Touchscreen when you press **Scan** and choose a scan option. For details, see *Configure Network Scanning for Macintosh* in the *Software and Network User's Guide*.

- f** When the **Add Printer** screen appears, click **Add Printer**.

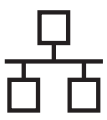

- g** Choose your machine from the list. Click **Add** and then click **Next**.

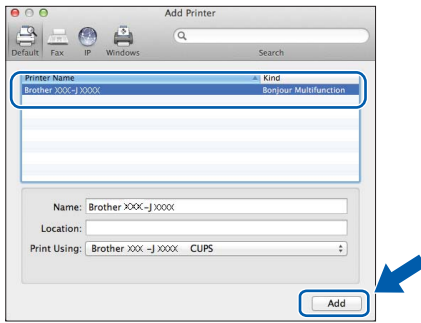

NOTE

(OS X v10.8.x)

Select **Brother MFC-XXXX CUPS** (where XXXX is your model name) driver from the **Use** pop-up menu.

When the support screen appears, follow the on-screen instructions if you want to download **Presto! PageManager**. You can also download **Presto! PageManager** later from the **Brother Support** screen. Click **Next**.

- h** When this screen appears, click **Close**.

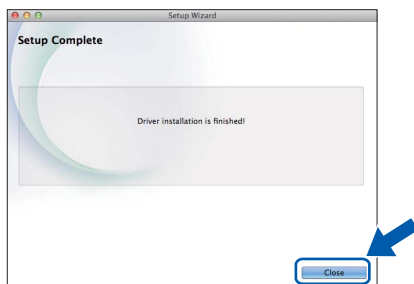

The installation of MFL-Pro Suite is now complete. Go to step 20.

20 Download and install Presto! PageManager

When Presto! PageManager is installed, OCR capability is added to Brother ControlCenter2. You can easily scan, share and organize photos and documents using Presto! PageManager.

- a** On the **Brother Support** screen, click the **Presto! PageManager** icon to go to the Presto! PageManager download site, and follow the on-screen instructions.

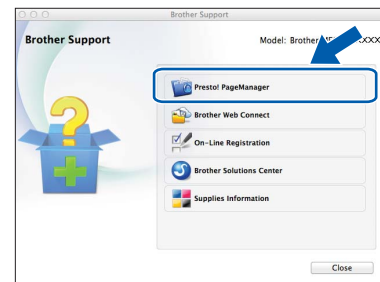

21 Install MFL-Pro Suite on additional computers (if needed)

If you want to use your machine with multiple computers on the network, install MFL-Pro Suite on each computer. Go to step 19 on page 27. Also see step 17 on page 26 before you install.

Finish

The installation is now complete.

NOTE

To use a mobile device with your Brother machine, see the User's Guide by visiting the Brother Solutions Center at <http://solutions.brother.com/> and clicking Manuals on your model's page.



For wireless network interface users

17 Before you begin

First you must configure the wireless network settings of your machine to communicate with your access point/router. After the machine is configured to communicate with your access point/router, computers on your network will have access to the machine. To use the machine from these computers, you will need to install the drivers and software. The following steps will guide you through the configuration and installation process.

To achieve optimum results with normal everyday document printing, place the Brother machine as close to the network access point/router as possible with minimal obstructions. Large objects and walls between the two devices as well as interference from other electronic devices can affect the data transfer speed of your documents.

Due to these factors, wireless may not be the best method of connection for all types of documents and applications. If you are printing large files, such as multi-page documents with mixed text and large graphics, you may want to consider choosing wired Ethernet for a faster data transfer or USB for the fastest throughput speed.

Although your Brother machine can be used in both a wired and wireless network, only one of the connection methods can be used at a time.

NOTE

If you have previously configured the wireless settings of the machine, you must reset the network settings before you can configure the wireless settings again.

On your machine, press  (Settings). Press All Settings.

Press **▲** or **▼** to display Network. Press Network.

Press **▲** or **▼** to display Network Reset. Press Network Reset.

Press Yes to accept. Hold down Yes for two seconds to confirm.

The following instructions are for infrastructure mode (connected to a computer through an access point/router).

Infrastructure Mode

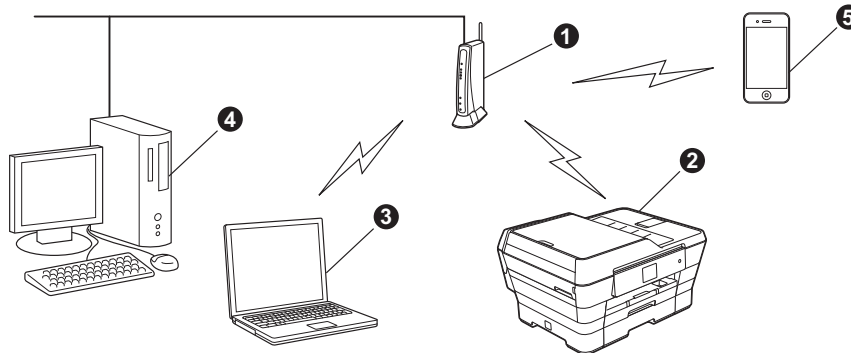

- ① Access point/router
- ② Wireless network machine (your machine) connected to the access point/router
- ③ Wireless-capable computer connected to the access point/router
- ④ Wired computer connected to the access point/router
- ⑤ Mobile device connected to the access point/router

Please make sure the wireless network settings of the machine match the access point/router.

NOTE

To set up your machine in Ad-hoc mode, see *Connected to a Wireless Computer without a Wireless LAN Access Point Router in the Network (Ad-Hoc Mode)* in the *Software and Network User's Guide* on the CD-ROM.

To view the *Software and Network User's Guide*:

- 1 Turn on your computer. Insert the CD-ROM into your CD-ROM drive.

For Windows®:

- 2 Choose your model and the language. The CD-ROM top menu will appear.
- 3 Click **User's Guides**, and then click **PDF/HTML documents**.
- 4 Click *Software and Network User's Guide*.

For Macintosh:

- 2 Double-click **User's Guides**. Choose your model and the language.
- 3 Click **User's Guides**, and then click *Software and Network User's Guide*.



18

Choose your wireless setup method

The following instructions will offer three methods for setting up your Brother machine on a wireless network. Choose the method you prefer for your environment.

Method **a** is the recommended way to connect (Windows® or Macintosh).

a Setup using the CD-ROM (Windows® and Macintosh)

- We recommend using a computer wirelessly connected to your network for this method.
- A USB cable might be needed in some cases.

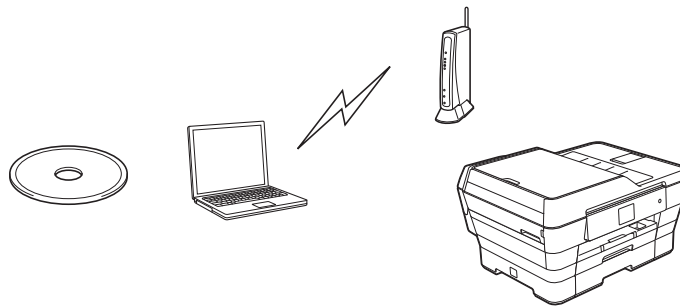

Now go to

page 32



For Wireless Network Users

For methods **b** and **c**, start your wireless setup by pressing the  Wi-Fi® button on the Touchscreen.



b Manual setup from the control panel using the Setup Wizard (Windows®, Macintosh and mobile devices)

If your wireless access point/router does not support WPS (Wi-Fi Protected Setup™) or AOSS™, **write down the wireless network settings** of your wireless access point/router in the area below.

If you need assistance during setup and want to contact Brother Customer Service, make sure you have your SSID (Network Name) and Network Key ready. We cannot assist you in locating this information.

Item	Record the current wireless network settings
SSID (Network Name)	
Network Key*	

* The Network Key may also be described as the Password, Security Key, or Encryption Key.

NOTE

If you do not know this information (SSID and Network Key), you cannot continue the wireless setup.

How can I find this information?

- 1) Check the documentation provided with your wireless access point/router.
- 2) The initial SSID could be the manufacturer's name or the model name.
- 3) If you do not know the security information, please consult the router manufacturer, your system administrator, or your Internet provider.

Now go to

page 33

c One-push setup using WPS or AOSS™ (Windows®, Macintosh and mobile devices)

Use this method if your wireless access point/router supports automatic wireless (one-push) setup (WPS or AOSS™).

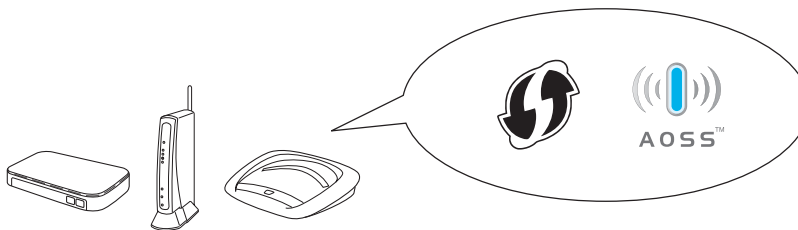

Now go to

page 35



19 Setup using the CD-ROM (Windows® and Macintosh)

For Macintosh Users:

Put the CD-ROM into your CD-ROM drive and double-click **Start Here OSX**. Select **Wireless Network Connection** and follow the **Wireless Device Setup** instructions on your computer screen. When setup is complete, go to **step 21-e** on page 41.

For Windows® Users:

- a** Put the CD-ROM into your CD-ROM drive. If the model name screen appears, choose your machine. If the language screen appears, choose your language.

NOTE

- If the Brother screen does not appear automatically, go to **Computer (My Computer)**.
(For Windows® 8: click the  (**File Explorer**) icon on the taskbar, and then go to **Computer**.) Double-click the CD-ROM icon, and then double-click **start.exe**.
- If the User Account Control screen appears, click **Allow** or **Yes**.

- b** Click **Install MFL-Pro Suite** and click **Yes** if you accept the license agreements. Follow the on-screen instructions.

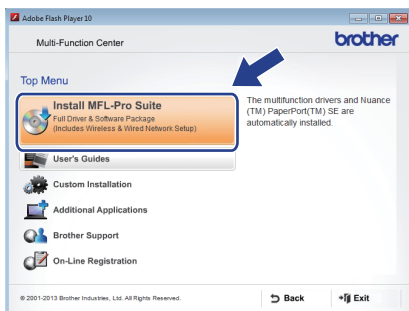

- c** Choose **Wireless Network Connection**, and then click **Next**.

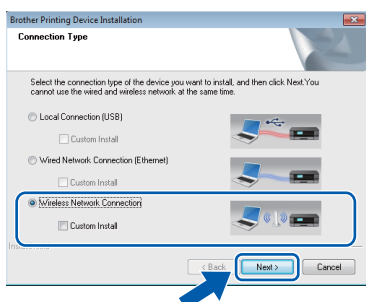

- d** When the **Firewall/AntiVirus detected** screen appears, choose **Change the Firewall port settings to enable network connection and continue with the installation. (Recommended)**, and then click **Next**.

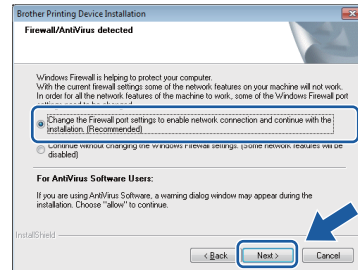

If you are not using the Windows® Firewall, see the instructions provided with your firewall software for information on how to add the following network ports.

- For network scanning, add UDP port 54925.
- For network PC-Fax receiving, add UDP port 54926.
- If you still have trouble with your network connection, add UDP ports 137 and 161.

- e** Follow the on-screen instructions to set up the Brother machine.

- f** Your machine will now try to connect to your wireless network. It may take a few minutes.

NOTE

If the connection failed, check the error code on the printed report (or on the screen), and refer to **Troubleshooting** on page 36.



Wireless setup is now complete.

The **Wi-Fi LED**  on the control panel lights up, indicating that the machine's **Network I/F** is set to **WLAN**.

To install MFL-Pro Suite

For Windows® users:

Now go to

Step 21-e on page 39



19 Manual setup from the control panel using the Setup Wizard (Windows®, Macintosh and mobile devices)

You must have the wireless settings you wrote down for your network in step 18-b on page 31 before you proceed.

a Press .
Press Setup Wizard.

When Switch Network interface to wireless? is displayed, press Yes to accept. This will start the wireless setup wizard. To cancel, press No.

b The machine will search for available SSIDs. It will take several seconds to display a list of available SSIDs.
If a list of SSIDs is displayed, press ▲ or ▼ to choose the SSID you wrote down in step 18-b on page 31.
Press OK.

If the wireless access point/router of the selected SSID supports WPS and the machine asks to use WPS, go to **c**.
If the machine asks you to enter a Network Key, go to **d**.
Otherwise, go to **e**.

NOTE



- If the list is blank, check that the wireless access point/router has power and is broadcasting the SSID. Move your machine closer to the wireless access point/router and try starting from **a** again.
- If your access point is set to not broadcast the SSID, you will have to manually add the SSID name. For more information, see *Configure Your Wireless Network When the SSID Is Not Broadcast* in the *Software and Network User's Guide*.

c Press Yes to connect your machine using WPS. (If you choose No (Manual) to continue manual configuration, go to **d** to enter a Network Key.)

When the Touchscreen instructs you to start WPS, press the WPS button on your wireless access point/router, and then press Next to proceed.
Go to **e**.

d Enter the Network Key you wrote down in step 18-b on page 31 using the Touchscreen.

NOTE

Press  to cycle between lower case and upper case. Press  to cycle between letters, numbers and special characters. (The characters available may differ depending on your country.) To move the cursor to the left or right, press ◀ or ▶.
(For more information, see *Entering Text* on page 44.)

Press OK when you have entered all the characters, then press Yes to apply your settings.

e Your machine will now try to connect to your wireless network. It may take a few minutes.
Press OK.

NOTE

If the connection failed, check the error code on the printed report and refer to *Troubleshooting* on page 36.



Wireless setup is now complete.

The Wi-Fi LED  on the control panel lights up, indicating that the machine's Network I/F is set to WLAN.



For mobile device users:

- Connect your mobile device to a wireless access point/router using a Wi-Fi connection.
- Download and install Brother iPrint&Scan (Android™/iOS/Windows® Phone) from your mobile device's application download site. You can also use AirPrint (iOS) with this machine.
- To download the User's Guide for the application you are using (Brother iPrint&Scan/AirPrint), visit the Brother Solutions Center and click Manuals on your model's page.

Now go to

<http://solutions.brother.com/>

To install MFL-Pro Suite, continue to step 20.

For Windows® users:

Now go to

Page 38

For Macintosh users:

Now go to

Page 41



19 One-push setup using WPS or AOSS™ (Windows®, Macintosh and mobile devices)

a Confirm your wireless access point/router has the WPS or AOSS™ symbol as shown below.



b Place the Brother machine within range of your WPS or AOSS™ access point/router. The range may differ depending on your environment. Refer to the instructions provided with your access point/router.

c Press **WiFi**.
Press **WPS/AOSS**.

When **Switch Network interface to wireless?** is displayed, press **Yes** to accept. This will start the wireless setup wizard. To cancel, press **No**.

NOTE

If your wireless access point/router supports WPS and you want to configure your machine using the PIN (Personal Identification Number) Method, see *Configure Your Wireless Network Using the PIN Method of Wi-Fi Protected Setup™ (WPS)* in the *Software and Network User's Guide*.

d When the Touchscreen instructs you to start WPS or AOSS™, press the WPS or AOSS™ button on your wireless access point/router (for more information, see the instructions provided with your wireless access point/router), and then press **OK** on your machine.

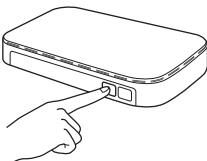

This feature will automatically detect which mode (WPS or AOSS™) your wireless access point/router uses to configure your machine.

Press **OK**.

NOTE

If the connection failed, check the error code on the printed report and refer to *Troubleshooting* on page 36.

OK! Wireless setup is now complete.

The **Wi-Fi LED**  on the control panel lights up, indicating that the machine's Network I/F is set to **WLAN**.

For mobile device users:

- Connect your mobile device to a wireless access point/router using a Wi-Fi connection.
- Download and install Brother iPrint&Scan (Android™/iOS/Windows® Phone) from your mobile device's application download site. You can also use AirPrint (iOS) with this machine.
- To download the User's Guide for the application you are using (Brother iPrint&Scan/AirPrint), visit the Brother Solutions Center and click Manuals on your model's page.

Now go to

<http://solutions.brother.com/>

To install MFL-Pro Suite, continue to step 20.

For Windows® users:

Now go to

Page 38

For Macintosh users:

Now go to

Page 41



Troubleshooting

If you need assistance during setup and want to contact Brother Customer Service, make sure you have your SSID (Network Name) and Network Key ready. We cannot assist you in locating this information.



How can I find the wireless security information (SSID and Network Key*)

- 1) Check the documentation provided with your wireless access point/router.
- 2) The initial SSID could be the manufacturer's name or the model name.
- 3) If you do not know the security information, please consult the router manufacturer, your system administrator, or your Internet provider.

* The Network Key may also be described as the Password, Security Key or Encryption Key.

Wireless LAN report

If the wireless LAN report that printed shows that the connection failed, check the error code on the printed report and refer to the following instructions.

Error code	Recommended Solutions
TS-01	<p>The wireless setting is not activated, turn the wireless setting to ON.</p> <ul style="list-style-type: none"> - If a network cable is connected to your machine, disconnect it and turn the wireless setting of your machine to ON. <p>On your machine, press  (Settings). Press All Settings. Press ▲ or ▼ to display Network. Press Network. Press ▲ or ▼ to display Network I/F. Press Network I/F. Press WLAN. Press .</p>
TS-02	<p>The wireless access point/router cannot be detected.</p> <ol style="list-style-type: none"> 1. Check the following 4 points. <ul style="list-style-type: none"> - Make sure that the wireless access point/router is powered on. - Move your machine to an obstruction-free area, or closer to the wireless access point/router. - Temporarily place your machine within about 3.3 feet (one meter) from the wireless access point when you are configuring the wireless settings. - If your wireless access point/router is using MAC address filtering, confirm the MAC address of the Brother machine is allowed in the filter. 2. If you manually entered the SSID and security information (SSID/authentication method/encryption method/Network Key), the information may be incorrect. Reconfirm the SSID and security information and re-enter the correct information as necessary. See <i>How can I find the wireless security information (SSID and Network Key*)</i> on page 36 to confirm.

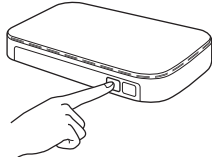

TS-04	<p>The Authentication/Encryption methods used by the selected wireless access point/router are not supported by your machine.</p> <p>For infrastructure mode, change the authentication and encryption methods of the wireless access point/router. Your machine supports the following authentication methods:</p> <table border="1" data-bbox="331 394 1093 658"> <thead> <tr> <th>Authentication method</th> <th>Encryption method</th> </tr> </thead> <tbody> <tr> <td rowspan="2">WPA-Personal</td> <td>TKIP</td> </tr> <tr> <td>AES</td> </tr> <tr> <td>WPA2-Personal</td> <td>AES</td> </tr> <tr> <td rowspan="2">Open</td> <td>WEP</td> </tr> <tr> <td>None (without encryption)</td> </tr> <tr> <td>Shared key</td> <td>WEP</td> </tr> </tbody> </table> <p>If your problem is not solved, the SSID or network settings you entered may be incorrect. Reconfirm the wireless network settings. See <i>How can I find the wireless security information (SSID and Network Key*)</i> on page 36 to confirm.</p> <p>For ad-hoc mode, change the authentication and encryption methods of your computer for the wireless setting. Your machine supports Open authentication method only, with optional WEP encryption.</p>	Authentication method	Encryption method	WPA-Personal	TKIP	AES	WPA2-Personal	AES	Open	WEP	None (without encryption)	Shared key	WEP
Authentication method	Encryption method												
WPA-Personal	TKIP												
	AES												
WPA2-Personal	AES												
Open	WEP												
	None (without encryption)												
Shared key	WEP												
TS-05	<p>The security information (SSID/Network Key) is incorrect.</p> <p>Reconfirm the SSID and security information (Network Key). See <i>How can I find the wireless security information (SSID and Network Key*)</i> on page 36 to confirm.</p> <p>If your router uses WEP encryption, enter the key used as the first WEP key. Your Brother machine supports the use of the first WEP key only.</p>												
TS-06	<p>The wireless security information (Authentication method/Encryption method/Network Key) is incorrect.</p> <p>Reconfirm the wireless security information (Authentication method/Encryption method/Network Key) in the table of TS-04. See <i>How can I find the wireless security information (SSID and Network Key*)</i> on page 36 to confirm.</p> <p>If your router uses WEP encryption, enter the key used as the first WEP key. Your Brother machine supports the use of the first WEP key only.</p>												
TS-07	<p>The machine cannot detect a wireless access point/router that has WPS or AOSS™ enabled.</p> <p>If you would like to configure your wireless settings using WPS or AOSS™, you must operate both your machine and the wireless access point/router. Confirm your wireless access point/router supports WPS or AOSS™ and try starting again.</p> <p>If you do not know how to operate your wireless access point/router using WPS or AOSS™ see the documentation provided with your wireless access point/router, ask the manufacturer of your wireless access point/router or ask your network administrator.</p> 												
TS-08	<p>Two or more wireless access points that have WPS or AOSS™ enabled are detected.</p> <ul style="list-style-type: none"> - Confirm that only one wireless access point/router within range has the WPS or AOSS™ method active and try again. - Try starting again after a few minutes in order to avoid interference from other access points. 												



Install the drivers and software

(Windows® XP Home/XP Professional/Windows Vista®/Windows® 7/Windows® 8)

20 Before you install

Make sure that your computer is ON and you are logged on with Administrator rights.

NOTE

- If there are any programs running, close them.
- The screens may differ depending on your operating system.
- The CD-ROM includes Nuance™ PaperPort™ 12SE. This software supports Windows® XP Home (SP3 or greater), XP Professional (SP3 or greater), XP Professional x64 Edition (SP2 or greater), Windows Vista® (SP2 or greater), Windows® 7 and Windows® 8. Update to the latest Windows® Service Pack before installing MFL-Pro Suite.

21 Install MFL-Pro Suite

- a** Put the CD-ROM into your CD-ROM drive. If the model name screen appears, choose your machine. If the language screen appears, choose your language.

NOTE

- If the Brother screen does not appear automatically, go to **Computer (My Computer)**.
(For Windows® 8: click the  (File Explorer) icon on the taskbar, and then go to **Computer**.)
Double-click the CD-ROM icon, and then double-click **start.exe**.
- If the User Account Control screen appears, click **Allow** or **Yes**.

- b** Click **Install MFL-Pro Suite** and click **Yes** if you accept the license agreements. Follow the on-screen instructions.

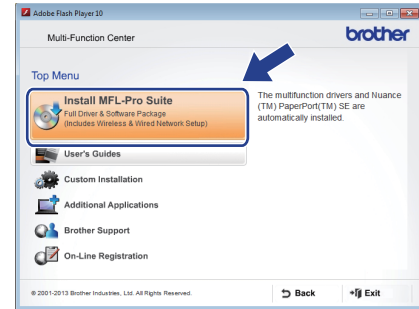

- c** Choose **Wireless Network Connection**, and then click **Next**.

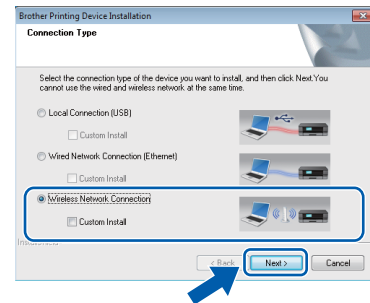

- d** When the **Firewall/AntiVirus detected** screen appears, choose **Change the Firewall port settings to enable network connection and continue with the installation. (Recommended)**, and then click **Next**.

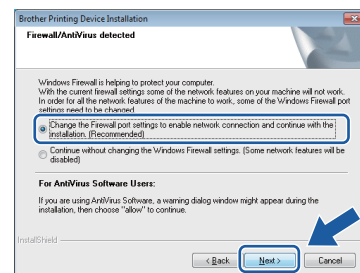

If you are not using the Windows® Firewall, see the instructions provided with your firewall software for information on how to add the following network ports.

- For network scanning, add UDP port 54925.
- For network PC-Fax receiving, add UDP port 54926.
- If you still have trouble with your network connection, add UDP ports 137 and 161.



- e Choose your machine from the list, and then click **Next**.

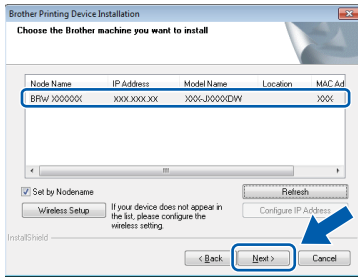

NOTE

- If your machine is not found over the network, confirm your settings by following the on-screen instructions. If you encounter this failure, go to step **18-b** on page 31 and set up the wireless connection again.
- If you are using WEP and the Touchscreen displays *Connected* but your machine is not found on the network, make sure you entered the WEP key correctly. The WEP key is case-sensitive.

- f The installation of the Brother drivers will automatically start. The installation screens appear one after another.

NOTE

- DO NOT cancel any of the screens during the installation. It may take a few seconds for all screens to appear.
- If the **Windows Security** screen appears, click the check box and click **Install** to complete the installation correctly.

- g If the **Environmental Advice for Imaging Equipment** screen appears, click **Next**.

- h When the **On-Line Registration** screen appears, follow the on-screen instructions. Click **Next**.

- i If you do not want to set your machine as the default printer, clear the **Set as Default Printer** check box, and then click **Next**.

- j When the **Setup is Complete** window appears, confirm the settings, and then click **Next**.

22 Finish and restart

- a Click **Finish** to restart your computer. After restarting the computer, you must log on with Administrator rights.

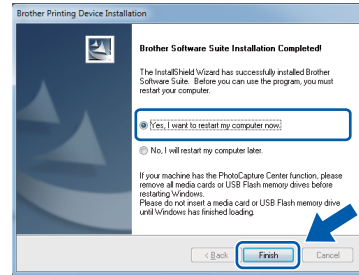

NOTE

- If an error message appears during the software installation, do one of the following:
 - Windows® XP, Windows Vista® and Windows® 7 users: Run the **Installation Diagnostics** located in **(Start) > All Programs > Brother > MFC-XXXX LAN** (where XXXX is your model name).
 - Windows® 8 users: To run the **Installation Diagnostics**, double-click  (**Brother Utilities**) on the desktop, and then click the drop-down list and select your model name (if not already selected). Click **Tools** in the left navigation bar.
- Depending on your security settings, a Windows® Security or antivirus software window may appear when using the machine or its software. Please allow or permit the window to continue.



b The following screens will appear.

- When the **Software Update Setting** screen appears, choose the software update setting you want and click **OK**.
- When the Brother Product Research and Support Program screen appears, select your preference and follow the on-screen instructions.

NOTE

- Internet access is required for the software update and the Brother Product Research and Support Program.
- When you install MFL-Pro Suite, Brother Help will also be installed automatically. Brother Help allows you to access the Brother Solutions Center when you click  in the task tray.

23 Install MFL-Pro Suite on additional computers (if needed)

If you want to use your machine with multiple computers on the network, install MFL-Pro Suite on each computer. Go to step **20** on page 38.

NOTE

Network license (Windows®)

This product includes a PC license for up to two users. This license supports the installation of the MFL-Pro Suite including Nuance™ PaperPort™ 12SE on up to two PCs on the network. If you want to use more than two PCs with Nuance™ PaperPort™ 12SE installed, please purchase the Brother NL-5 pack which is a multiple PC license agreement pack for up to five additional users. To purchase the NL-5 pack, contact your authorized Brother dealer or contact Brother customer service.

Finish

The installation is now complete.

To install optional applications:

Now go to

Page 43

NOTE

Windows® 8 users: If the Brother manuals included on the CD-ROM are in PDF format, use Adobe® Reader® to open them. If Adobe® Reader® is installed on your computer but you cannot open the files in Adobe® Reader®, change the file association for PDF (see *How to open a PDF file in Adobe® Reader® (Windows® 8)* on page 45).



Install the drivers and software (Mac OS X v10.6.8, 10.7.x, 10.8.x)

20 Before you install

Make sure your machine is connected to the power and your Macintosh is ON. You must be logged on with Administrator rights.

NOTE

For Mac OS X v10.6.0 to 10.6.7 users, upgrade to Mac OS X v10.6.8 - 10.8.x.

21 Install MFL-Pro Suite

- a Put the CD-ROM into your CD-ROM drive.
- b Double-click the **Start Here OSX** icon to install. If the model name screen appears, choose your machine.



- c Choose **Wireless Network Connection**, and then click **Next**.

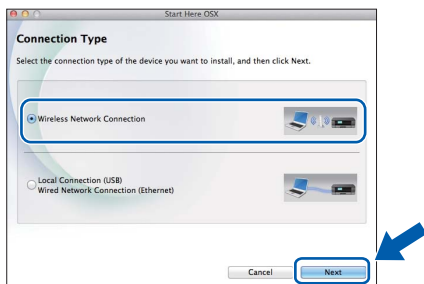

- d After the installation, the Brother software will search for the Brother device. This will take a few moments to complete.

- e Choose your machine from the list, and then click **Next**.

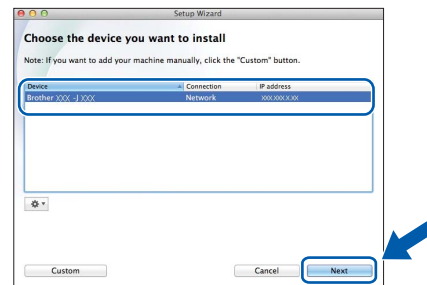

NOTE

If your wireless settings fail, the **Wireless Device Setup Wizard** screen appears. Follow the on-screen instructions to complete the wireless configuration.



- f The installation of the Brother drivers will automatically start. Please wait for the software to install.

NOTE

- You can find your machine's MAC Address (Ethernet Address) and IP Address by printing out the Network Configuration Report. See *Print the Network Configuration Report* in the *Software and Network User's Guide*.
- If the **Setup Network "Scan to" name** screen appears, follow the instructions below.

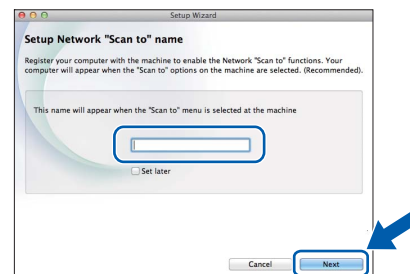

- 1) Enter a name for your Macintosh (up to 15 characters long).
- 2) Click **Next**. Go to **g**.

The name you enter will appear on the machine's Touchscreen when you press **Scan** and choose a scan option. For details, see *Configure Network Scanning for Macintosh* in the *Software and Network User's Guide*.



g When the **Add Printer** screen appears, click **Add Printer**.

h Choose your machine from the list, click **Add**, and then click **Next**.

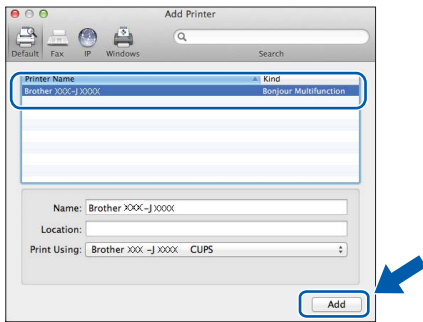

NOTE

(OS X v10.8.x)

Select **Brother MFC-XXXX CUPS** (where XXXX is your model name) driver from the **Use** pop-up menu.

When the support screen appears, follow the on-screen instructions if you want to download **Presto! PageManager**. You can also download **Presto! PageManager** later from the **Brother Support** screen. Click **Next**.

i When this screen appears, click **Close**.

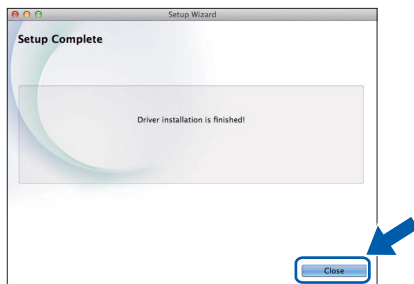

OK! The installation of MFL-Pro Suite is now complete. Go to step **22**.

22 Download and install Presto! PageManager

When Presto! PageManager is installed, OCR capability is added to Brother ControlCenter2. You can easily scan, share and organize photos and documents using Presto! PageManager.

a On the **Brother Support** screen, click the **Presto! PageManager** icon to go to the Presto! PageManager download site, and follow the on-screen instructions.

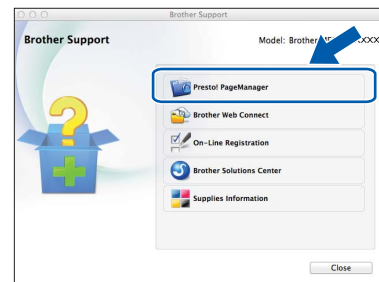

23 Install MFL-Pro Suite on additional computers (if needed)

If you want to use your machine with multiple computers on the network, install MFL-Pro Suite on each computer. Go to step **20** on page 41.

Finish

The installation is now complete.

1 Install optional applications

BookScan&Whiteboard Suite supported by Reallusion, Inc

The **BookScan Enhancer** software can correct your scanned book images automatically.
The **Whiteboard Enhancer** software cleans up and enhances text and images from photos taken of your whiteboard.

NOTE

- The machine must be ON and connected to the computer.
- Some applications require Internet access.
- Make sure you are logged on with Administrator rights.
- This application is not available for Windows Server® 2003/2008/2012 series.

a Open the top menu again by ejecting and then reinserting the CD-ROM or by double-clicking the **start.exe** program from the root folder.
If the language screen appears, choose your language.

b The CD-ROM **Top Menu** will appear. Click **Additional Applications**.

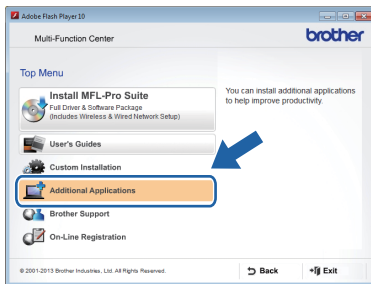

c Click the button for the application you want to install.

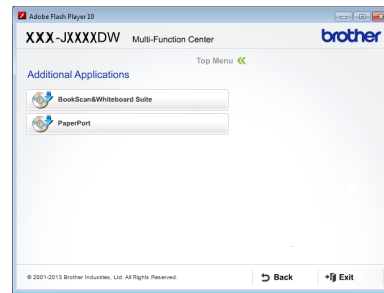

d When installation is complete, click the button for the next application you want to install.
To exit, click **Exit**.

NOTE

To start **BookScan&Whiteboard Suite**, double-click the shortcut icon on your desktop.

Reset the network settings to factory default

To restore all network settings of the internal Print/Scan server to the factory default, please follow the steps below:

- a** Make sure the machine is idle, then disconnect all the cables from the machine (except the power cord).
- b** Press  (Settings).
- c** Press All Settings.
- d** Press ▲ or ▼ to display Network.
Press Network.
- e** Press ▲ or ▼ to display Network Reset.
Press Network Reset.
- f** Press Yes.
- g** Hold down Yes for two seconds to confirm.
- h** The machine will restart, re-connect the cables once this is complete.

Entering Text

Press  to cycle between lower case and upper case.

Press  to cycle between letters, numbers and special characters. (The characters available may differ depending on your country.)

To move the cursor to the left or right, press ◀ or ▶.

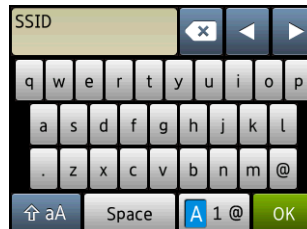

Inserting spaces

To enter a space, press Space.

Making corrections

If you entered a number or a character incorrectly and want to change it, press ◀ or ▶ move the cursor under the incorrect character, and then press . Enter the correct character. Use ◀ or ▶ to go back or forward to insert a character.

How to open a PDF file in Adobe® Reader® (Windows® 8)

- a** Move your mouse to the lower right corner of your desktop. When the menu bar appears, click **Settings**, and then click **Control Panel**.
- b** Click **Programs**, click **Default Programs**, and then click **Associate a file type or protocol with a program**.
- c** Select **.pdf**, and then click the **Change program...** button.
- d** Click **Adobe Reader**. The icon next to **.pdf** changes to the 'Adobe Reader' icon.

Adobe® Reader® is now the default application for reading .pdf files until you change this file association.

Brother CreativeCenter





Get inspired. If you're using Windows®, double-click the Brother CreativeCenter icon  on your desktop to access our FREE website with many ideas and resources for personal and professional use.

Mac users can access Brother CreativeCenter at <http://www.brother.com/creativecenter/>

Replacement consumables

When the time comes to replace ink cartridges, a message will be indicated on the Touchscreen. For more information about the ink cartridges for your machine, visit <http://www.brother.com/original/> or contact your local Brother re-seller.

Ink cartridge

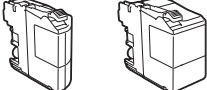
Magenta	Cyan	Yellow	Black
LC103M (High Yield) LC105M (Super High Yield)	LC103C (High Yield) LC105C (Super High Yield)	LC103Y (High Yield) LC105Y (Super High Yield)	LC103BK (High Yield) LC109BK (Super High Yield)
			

What is Innobella™?

Innobella™ is a range of genuine consumables offered by Brother.

The name “Innobella™” derives from the words “Innovation” and “Bella” (meaning “Beautiful” in Italian) and is a representation of the “innovative” technology providing you with “beautiful” and “long lasting” print results.



Trademarks

The Brother logo is a registered trademark of Brother Industries, Ltd.

Brother is a trademark of Brother Industries, Ltd.

Windows, Windows Vista and Windows Server are either registered trademarks or trademarks of Microsoft Corporation in the United States and/or other countries.

Apple, Macintosh, Mac OS and OS X are trademarks of Apple Inc., registered in the United States and other countries.

AirPrint is a trademark of Apple Inc.

Android is a trademark of Google Inc. Use of this trademark is subject to Google Permissions.

Adobe and Reader are either registered trademarks or trademarks of Adobe Systems Incorporated in the United States and/or other countries.

Nuance, the Nuance logo, PaperPort and ScanSoft are trademarks or registered trademarks of Nuance Communications, Inc. or its affiliates in the United States and/or other countries.

AOSS is a trademark of Buffalo Inc.

Wi-Fi and Wi-Fi Protected Access are registered trademarks of the Wi-Fi Alliance.

WPA, WPA2, Wi-Fi Protected Setup and Wi-Fi Protected Setup logo are trademarks of the Wi-Fi Alliance.

Each company whose software title is mentioned in this manual has a Software License Agreement specific to its proprietary programs.

Any trade names and product names of companies appearing on Brother products, related documents and any other materials are all trademarks or registered trademarks of those respective companies.

Compilation and Publication

Under the supervision of Brother Industries, Ltd., this manual has been compiled and published, covering the latest product descriptions and specifications.

The contents of this manual and the specifications of this product are subject to change without notice.

Brother reserves the right to make changes without notice in the specifications and materials contained herein and shall not be responsible for any damages (including consequential) caused by reliance on the materials presented, including but not limited to typographical and other errors relating to the publication.

Copyright and License

©2013 Brother Industries, Ltd. All rights reserved.

This product includes software developed by the following vendors:

©1983-1998 PACIFIC SOFTWARES, INC. ALL RIGHTS RESERVED.

©2008 Devicescape Software, Inc. All rights reserved.

This product includes the “KASAGO TCP/IP” software developed by ZUKEN ELMIC, Inc.



www.brotherearth.com